

**TRILUX**  
SIMPLIFY YOUR LIGHT.

## E-LINE NEXT LED

FROM EXPERIENCE.  
FROM THE MARKET.  
FOR THE FUTURE.

[www.trilux.com/eline-next](http://www.trilux.com/eline-next)



# NEXT

EVERYTHING REMAINS. **EXCEPT BETTER.**

**DISCOVER MANY NEW  
FEATURES NOW!**

**AR<sup>+</sup>**



## Experience E-Line Next LED in 3-D thanks to augmented reality



### 1. Load the TRILUX AR app

Scan the QR code or enter "TRILUX AR" into the search field of the App Store and download the free augmented reality app.



### 2. Activate the app

To use the augmented reality function, start the AR app. Now use the camera to scan the application pages and product pages marked with the AR symbol in this brochure. The 3-D model is displayed as soon as the angle and distance are correct. Click on the symbols and let the TRILUX world surprise you!

### 3. Experience TRILUX

Experience E-Line Next LED from TRILUX with augmented reality on your mobile device. Explore detailed 3-D models of the products from all sides and experience the variety and flexibility of this lighting system.



# CONTENTS

**E-Line Next LED –  
Everything remains. Except better.**

Augmented reality	Page 01
TRILUX – SIMPLIFY YOUR LIGHT	Pages 04 - 05
History of the E-Line	Pages 06 - 07
Everything remains. Except better.	Pages 10 - 11

**References**

Industry	Pages 12 - 13
Retail	Pages 14 - 15
Office	Pages 16 - 17
Education	Pages 18 - 19



**E-Line Next LED –  
everything remains. Except more flexible.**

System overview	Pages 22 - 23
Fix/Flex trunking	Pages 24 - 33
Gear trays/optics overview	Pages 34 - 41
Refurbishment	Pages 42 - 43
Module overview	Pages 44 - 47
Emergency light	Pages 48 - 51
Technical features	Pages 52 - 53
Nomenclature	Pages 54 - 55

**E-Line Next LED –  
everything remains. Except more efficient.**

Industry planning examples	Pages 58 - 61
Retail planning examples	Pages 62 - 65
Office planning examples	Pages 66 - 67
Education planning examples	Pages 68 - 69

**E-Line Next LED –  
everything remains. Except higher quality.**

More than just a product	Pages 72 - 73
Quickly and simply configured	Pages 74 - 75
Sustainability	Pages 76 - 79
Indoor light management	Pages 80 - 81
Human Centric Lighting	Pages 82 - 83
Lighting Solutions & Services	Pages 84 - 87
Quality made by TRILUX / sustainability	Pages 88 - 89

**E-Line Next LED –  
everything remains. Except simpler.**

TRILUX ONE	Pages 92 - 93
TRILUX Akademie	Pages 94 - 95
Contacts	Page 96

TRILUX

SIMPLIFY YOUR LIGHT





TRILUX SIMPLIFY YOUR LIGHT represents the simplest and most reliable path to customised, energy-efficient and future-proof lighting solutions. In the dynamic and ever increasingly complex lighting market, customers are provided with optimal advice, ideal orientation and perfect light. To ensure this, TRILUX offers a wide portfolio of technologies and services as well as high-performance partners and companies in the TRILUX Group. The lighting specialist combines single components to create custom-designed complete solutions – always perfectly tailored to the customer's requirements and specific applications.

This way, complex and extensive projects can be simply and rapidly implemented from a single supplier. According to the principle of SIMPLIFY YOUR LIGHT, simple planning, installation and ease of use is focused on for customers in addition to quality and efficiency.

## E-LINE NEXT LED

### HISTORY OF THE E-LINE

1999 ○

**T8 with 83 lm/W and 20,000 h service life**

With an improved wiring system and pre-assembled trunking couplings, E-Line is particularly easy to install.

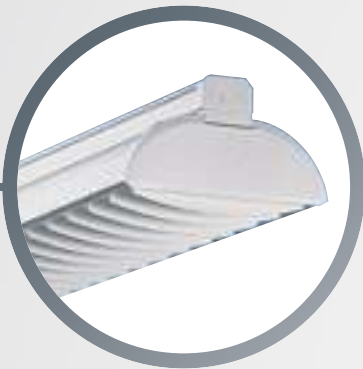

2004 ○

**T5 with 90 lm/W and 25,000 h service life**

E-Line becomes even more slender thanks to the T5 system. Reflectors and accessories for single and dual lamp solutions are simplified. Multi-lamp technology increases the efficiency and service life.

1992 ○

**T8 with 64 lm/W and 15,000 h service life**

The first rapid-mounting continuous line for tool-free installation. One innovation consists of the practical snap fasteners, still in use almost unchanged to this day.

## ○ 2010

### **T5 with 90 lm/W and 25,000 h service life**

Trunking and reflectors are optimised in length. A real plus: new optics made of Miro silver material for optimal reflection properties and maximum efficiency.



## ○ 2013

### **LED with 132 lm/W and > 50,000 h service life**

Perfect interaction: reflector, accessories and light sources merge into a single unit. Four beam angles and three luminous flux packages provide maximum flexibility.

## ○ 2017

### **LED with 169 lm/W and > 50,000 h service life**

With 13 optics and ten different luminous flux packages, E-Line LED becomes an all-rounder in all applications. The luminaire is foodstuff-compatible and optionally available as an IP54 version.

## **E-LINE – ALWAYS AHEAD OF ITS TIME**

The first TRILUX rapid-mounting continuous line already scored points in 1992 with maximum efficiency, quality and a consistent focus on customer benefits. Since then, we have continuously developed E-Line further. Only one factor has always remained the same:

our aim of advancing the lighting market through market-leading solutions with innovative technologies and practical features.



EVERYTHING REMAIN



**S. EXCEPT BETTER.**

## E-LINE NEXT LED

EVERYTHING REMAINS.  
EXCEPT BETTER.



### **E-LINE NEXT LED – EVERYTHING REMAINS. EXCEPT BETTER.**

It remains true to itself – and yet consistently takes the next step forward. Typical for E-Line Next LED are not only pioneering achievements in terms of efficiency, service life, quality of light and convenience. The modular system with its unique range of variants ensures made-to-measure, perfect lighting conditions in every application. And when it comes to sustainability, no wishes remain unfulfilled:  
E-Line Next LED as a Monitoring-Ready version opens up the potential of intelligent and networked lighting. This makes it the ideal choice for all continuous line projects, across all applications.



## EVERYTHING REMAINS – EXCEPT WITH HIGHER QUALITY

E-Line Next LED makes continuous lines "presentable" at all levels. On the one hand, the excellent quality of light with outstanding glare control and a colour rendering index of  $Ra > 90$  is impressive. This means that the continuous line meets even the highest demands, e.g. for quality control in the automotive industry. And on the other hand, E-Line Next LED wins over visually as well: the slender and attractive design of the optic and trunking without visible screw points or snap-in clips means that the continuous line blends harmoniously into high-quality environments – and enhances the atmosphere with its modern elegance.

## EVERYTHING REMAINS – EXCEPT SIMPLER

It couldn't be simpler: using a practical online configurator, users can customise a suitable continuous line for their project in just a few clicks. The final data can be easily stored, transferred to an ERP system and used for further projects. And the step into the future of lighting is also child's play with E-Line Next LED: on request, the continuous line can be quickly and easily networked and controlled via the LiveLink light management system – thus offering plug & play access to innovative services such as predictive maintenance.



## EVERYTHING REMAINS – EXCEPT MORE FLEXIBLE

More adaptable than ever: as an extremely flexible modular system, E-Line Next LED offers a unique variety of optics, lumen packages, module lengths, protection ratings and colour rendering indices. For the first time even two performance requirements can be covered with a single system, and innovative solutions such as Human Centric Lighting can be implemented across applications. The result: numerous possible combinations guarantee tailor-made light for every application, ranging from industry to retail and office to education.

## EVERYTHING REMAINS – EXCEPT MORE EFFICIENT

Pioneering: with energy efficiency of up to 190 lm/W and a 100,000 hour service life, the continuous line guarantees low operating costs in the long run. Thanks to many intelligent details, mounting is also more efficient than ever before. On request, E-Line Next LED is no longer delivered to the construction site in the usual 1 or 4 packs but in a large, tailor-made unit optimised in terms of packaging. This not only reduces packaging waste. It also saves time when unpacking and with garbage disposal, and accelerates mounting by up to 15 percent.



## REFERENCES

INDUSTRY

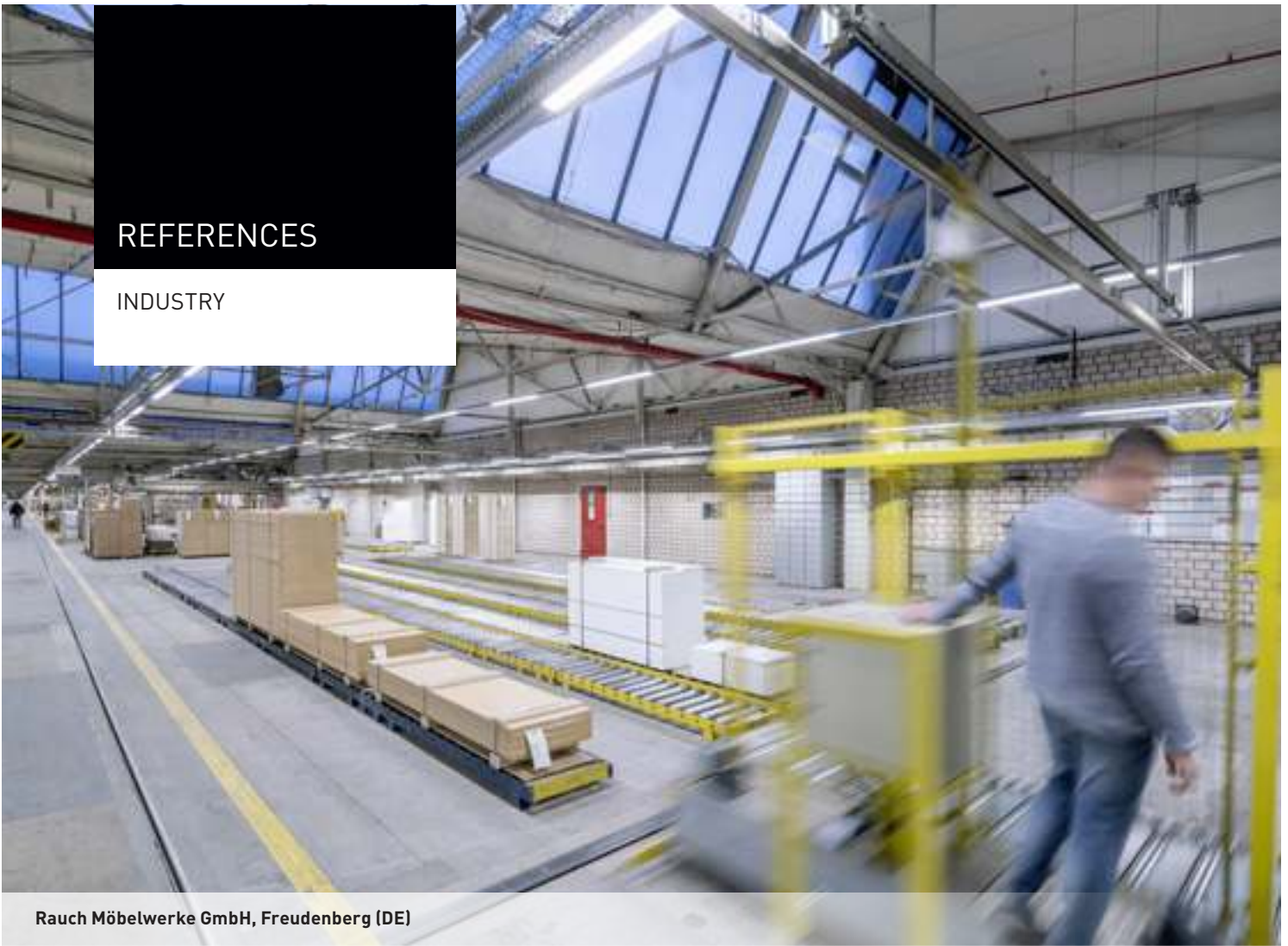

Rauch Möbelwerke GmbH, Freudenberg (DE)



DB Schenker, Verona (IT)



WIKA Schweiz AG, Hitzkirch (AT)



hygi.de GmbH & Co. KG, Telgte (DE)



Wiesheu Elektronik GmbH, Burgstetten (DE)

The pioneering modular system: with 20 optics and luminous flux packages from 2,000 to 20,000 lm, E-Line Next LED can be adapted to any application with unique precision. Sophisticated lighting technologies mean that luminaire quantities can be reduced. Quality of light and energy efficiency (up to 190 lm/W) set new standards. All modules are HCL-capable (Human Centric Lighting) to e.g. support the well-being of employees, especially during shift work.

## REFERENCES

RETAIL

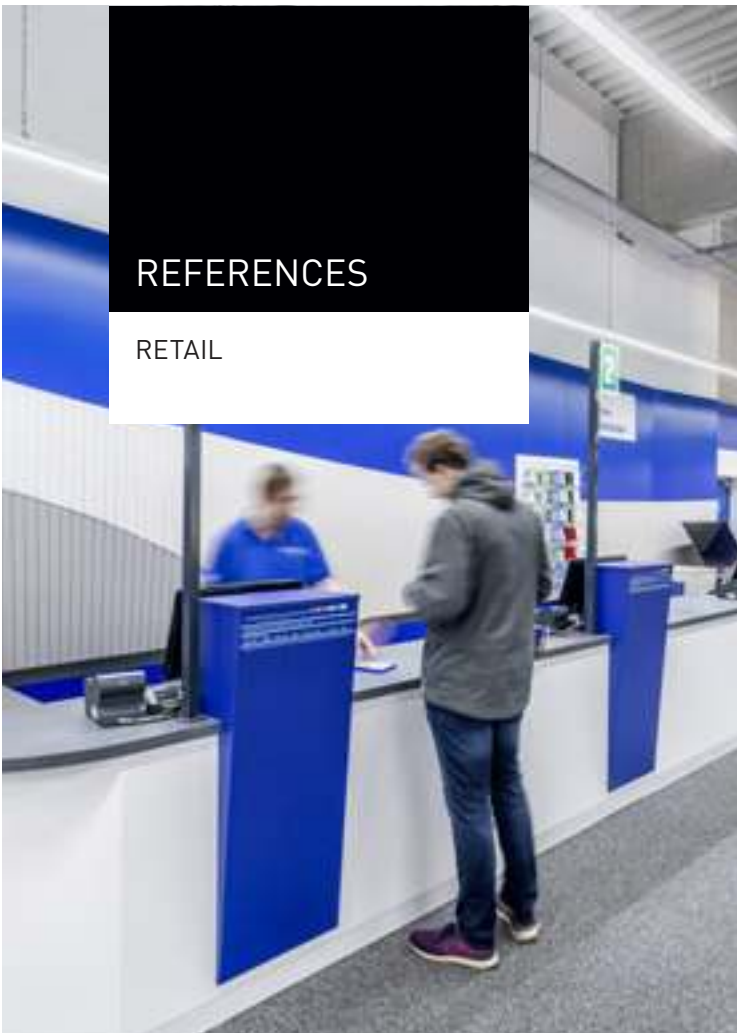

Euronics Berlet, Neheim (DE)



Macron Sportswear headquarters, Crespellano (IT)



Hagebau, Schönkirchen (DE)



familia supermarket, Timmendorfer Strand (DE)

Perfectly illuminated aisles and shelves, an attractive checkout area and a high quality ambience. With a colour rendering index of  $R_a > 90$  and various application-specific optics and spotlights, E-Line Next LED offers unique flexibility with illumination and accentuation, e.g. with two double asymmetric optics for different aisle widths and heights.

The new ConVision® technology also makes it possible to realise alternative design concepts that satisfy maximum demands in terms of design and quality of light.

# REFERENCES

OFFICE

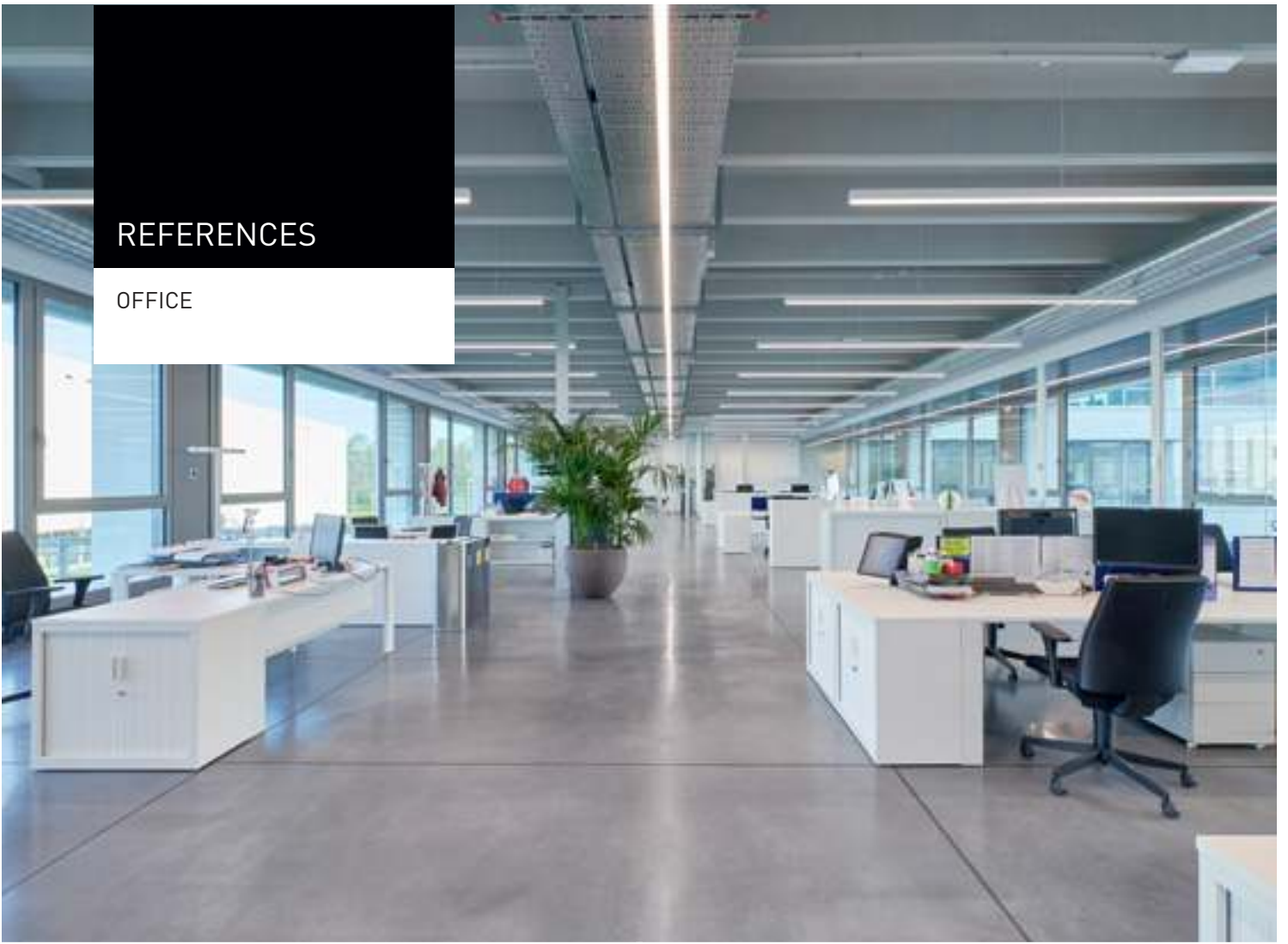

Macron Sportswear Headquarters, Crespellano (IT)



UPI, Berlin (DE)



Sortimo Innovation Park, Zusmarshausen (DE)



Ludwigslust-Parchim District Office (DE)

E-Line Next LED is the answer to a trend towards linear lighting systems in modern offices. With two different HCL-capable, VDU-compliant optics and spotlights as well as a colour rendering index of  $R_a > 90$ , the system ensures maximum visual comfort and employee well-being. Its attractive design is particularly well suited for example to office concepts with an industrial look.

# REFERENCES

EDUCATION



School, Brescia (IT)



Elektro Beckhoff GmbH Training Centre, Verl (DE)



Schule an der Wakenitz, Lübeck (DE)

See everything in a new light: E-Line Next LED is a real all-rounder thanks to various optics and spotlights. Whether shelf lighting in libraries, classrooms or for blackboard- or accent lighting, the modular system provides excellent quality of light for maximum visual comfort. In addition, all variants are HCL-compliant. This prevents eye fatigue and improves the ability to concentrate.

The background is a complex, blue, crystalline pattern. It consists of numerous interconnected, angular shapes that resemble a microscopic view of a material or a complex geometric structure. The colors range from deep navy blue to a lighter, almost cyan blue, with some areas appearing more reflective or highlighted. The overall effect is one of depth and intricate detail.

EVERYTHING REMAINS.

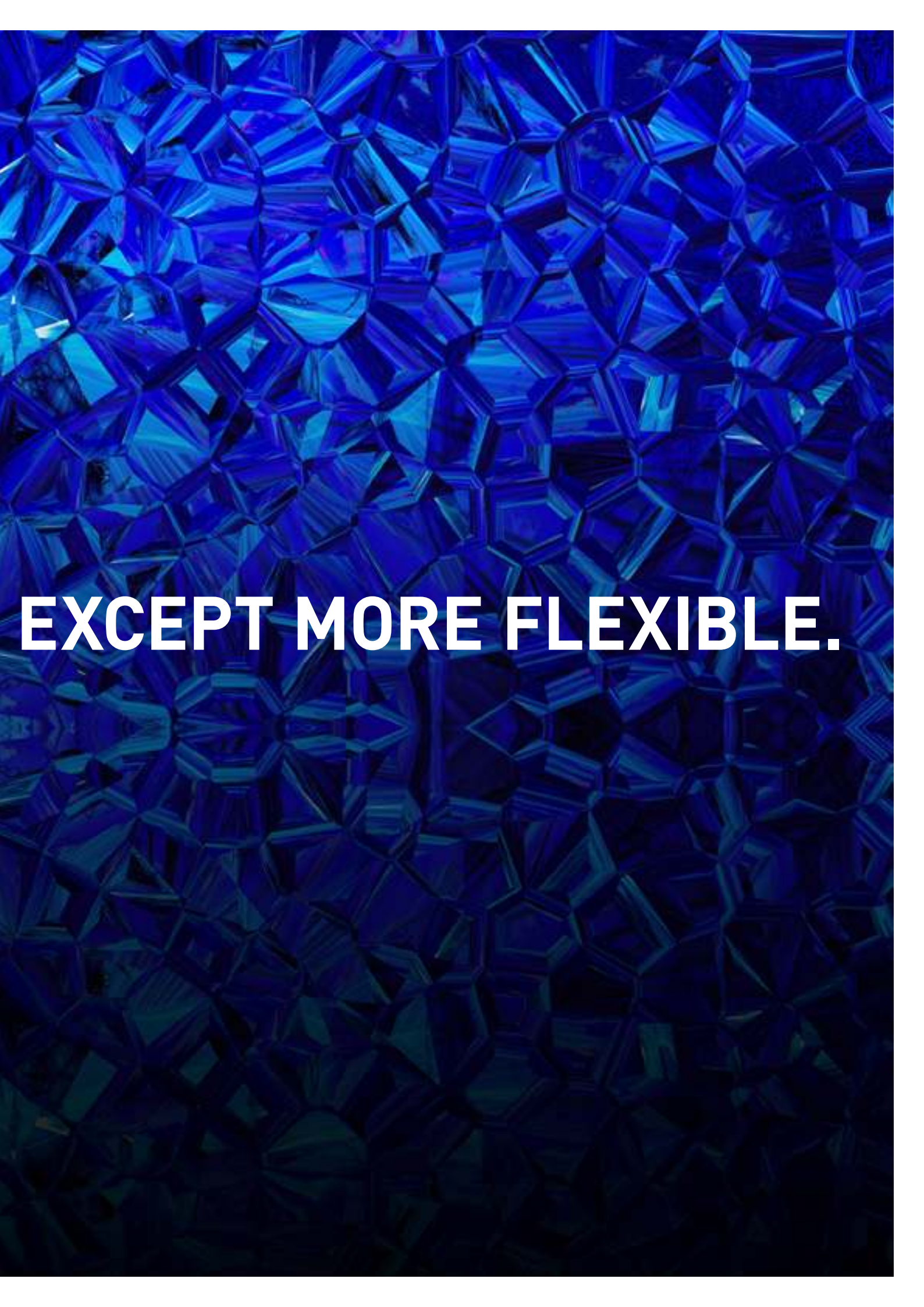

**EXCEPT MORE FLEXIBLE.**

## **The challenge**

LED continuous line systems have enormous potential, e.g. in industry, retail, office and education. However, most systems are too inflexible. The result is compromises in terms of quality of light, energy efficiency, design, controllability and future safety. This is a challenge for lighting designers and architects, a risk for operators and a nuisance for users.

## **The solution**

TRILUX has used 25 years of experience with continuous lines and radically upgraded the E-Line LED. With innovative technological possibilities for the market requirements of today and tomorrow. The result: E-Line Next LED. The modular system is uniquely versatile in its optics, lumen packages and lengths and covers two performance levels with one system. Pioneering in quality of light and energy efficiency (up to 190 lm/W), E-Line Next LED is the ideal solution for continuous line projects across all applications.

## **1 TRUNKING**

---

## **2 GEAR TRAYS**

---

## **3 MODULE OVERVIEW**

---

All familiar accessories can be found in the online catalogue.

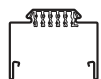

Trunking  
Flex



Trunking  
Fix

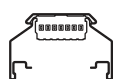

Trunking  
Fix IP64



Lens optics



Opal optics



Opal optics



Prismatic optics

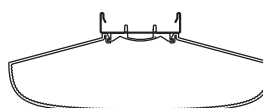

Prismatic optics

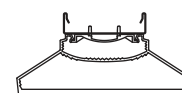

Prismatic optics  
(PMW)



ConVision<sup>®</sup>  
Optics

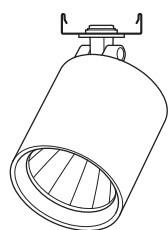

B.Veo LED

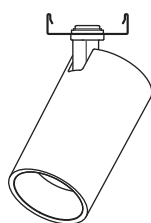

Lenty Plus LED

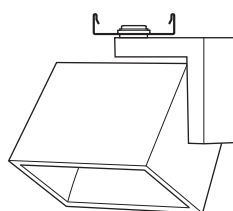

Grado LED

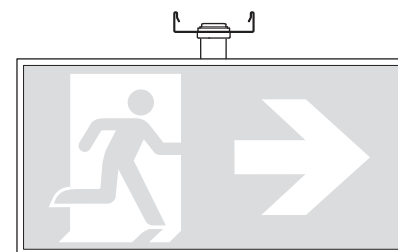

Pictogram



Mirona LED



Lightpanel LED

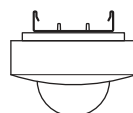

Sensor  
IS Highbay

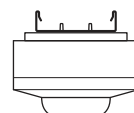

Sensor  
IR Quattro



Sensor  
IR Micro



Emergency light

## E-LINE NEXT LED

FIX/FLEX TRUNKING

### E-Line Flex

Flex trunking has continuous wiring, which allows flexible positioning of modules. The power supply is available with either 7 or 11 wires, so that emergency light modules can also be integrated.

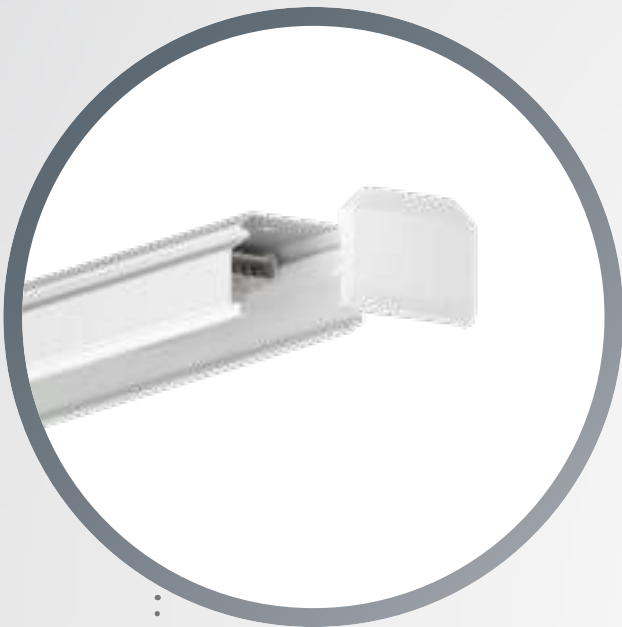

### E-Line Fix

The trunking of the Fix system is equipped with fixed female connectors with spacing distances of 368.75 mm, 1,475 mm or 2,212.50 mm to each other. The 368.75 mm version has 7-core wiring, the versions with lengths 1,475 mm and 2,212.50 mm can be supplied with either 7 or 14 (7+7) wires.

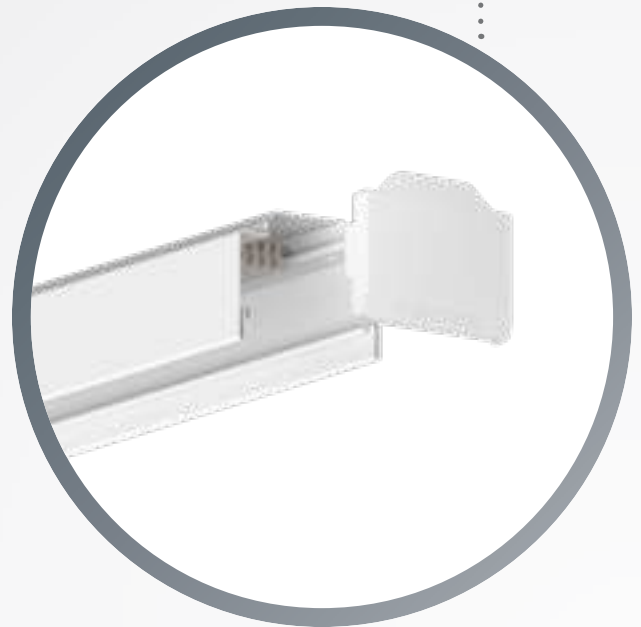

• **E-Line Fix IP64**

• The IP64 variant additionally covers  
• all applications with high safety  
• requirements or harsh general  
• conditions.

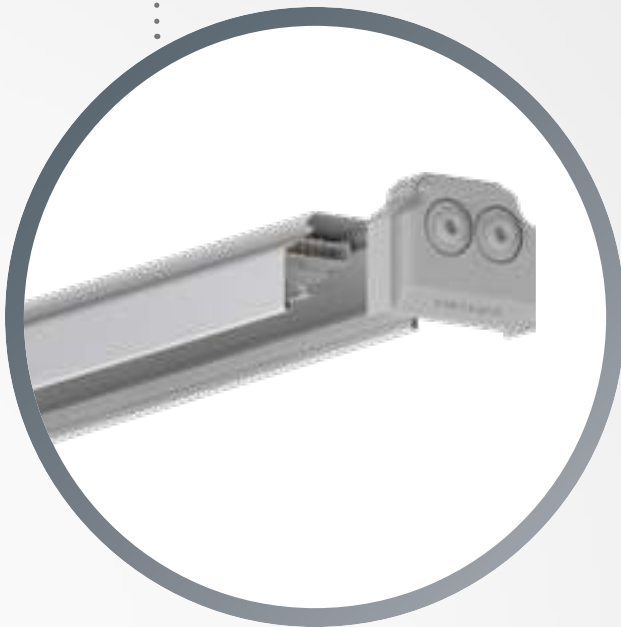

**Fix or Flex – from cost-efficient to maximum flexibility**

The trunking is available in two different systems, each with lengths of 737.50 mm, 1,475 mm, 2,212.50 mm, 2,950 mm or 4,425 mm. The Flex system has continuous wiring and thus enables modules to be freely positioned in the trunking. Ideal for maximum flexibility. The Fix system on the other hand has fixed female connectors – at spacing of either 368.75 mm, 1,475 mm or 2,212.50 mm.

**A tip:**  
save drilling  
points through  
suspension dis-  
tances of up to  
3.5 m.

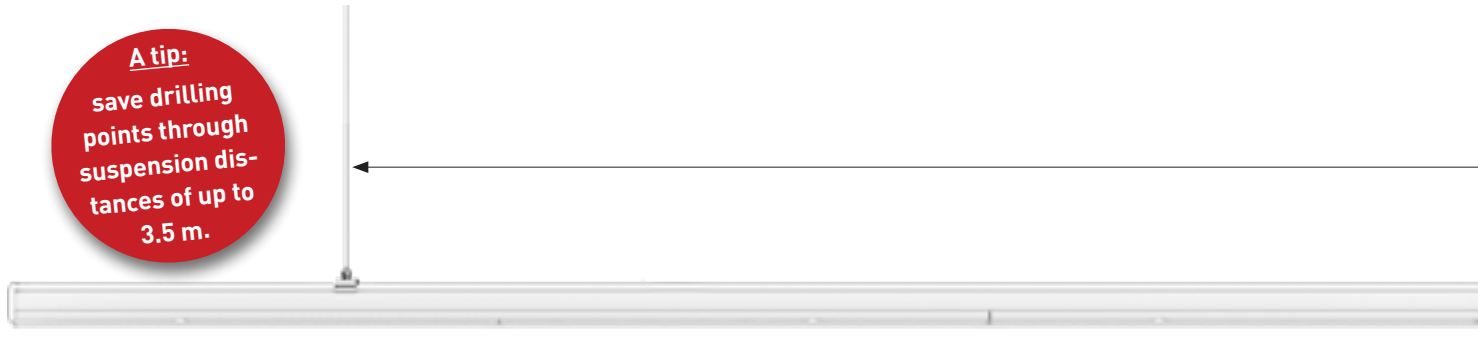

**E-Line Fix 2250** | optionally 7-core or 7+7-core | IP20 | IP50 | IP64



**E-Line Fix 1500** | optionally 7-core or 7+7-core | IP20 | IP50 | IP64



**E-Line Fix 375** | 7-core | IP20 | IP50



The trunking of the Fix variants has permanently mounted female connectors, arranged either every 368.75 mm, 1,475 mm or 2,212.50 mm. This enables different requirements to be taken into account during planning and lighting design. In retail areas for example the 368.75 mm arrangement ensures more flexibility in planning. For cost-sensitive projects, the Fix variant features trunking with female connector spacing of 2,212.50 mm. An IP64 variant additionally covers all applications with high safety requirements or harsh general conditions. In this way, almost all applications can be covered with E-Line Next LED.



**E-Line Fix LED**  
Classic design

up to 3,500 mm suspension distance\*

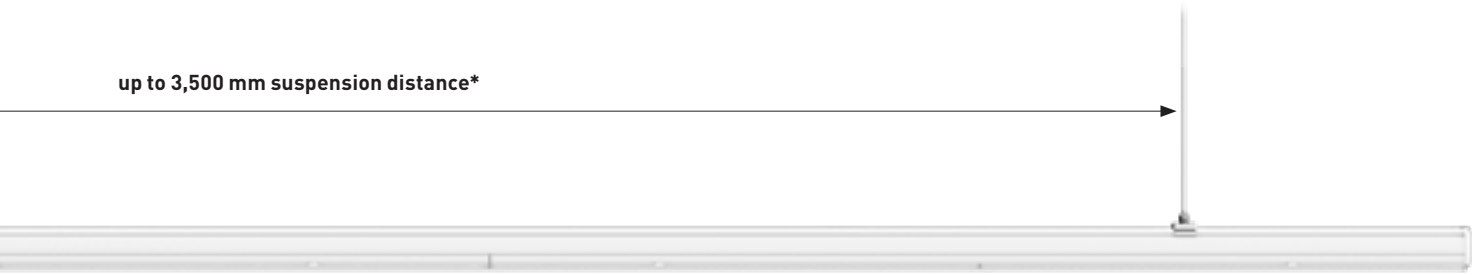

\*Suspension distances vary depending on the type of luminaire insert/module. For more detailed information, please refer to the installation instructions.



Female connectors every 2,212.50 mm | for trunking lengths of 2,212.50 mm or 4,425 mm | ideal for cost-sensitive projects



Female connectors every 1,475 mm | for trunking lengths of 737.50 mm, 1,475 mm, 2,950 mm or 4,425 mm | for luminaires with classic 1,500 size



Female connectors every 368.75 mm | for trunking lengths of 368.75 mm, 1,475 mm, 2,212.50 mm, 2,950 mm or 4,425 mm | for more flexibility with lighting design



**IP64 version**  
Increased protection rating thanks to specific design in which all lens optics can be used

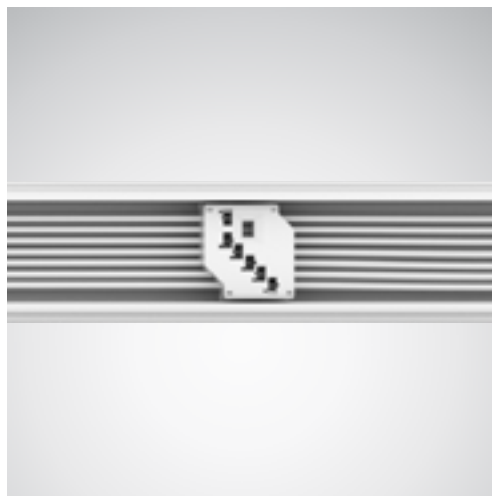

**7-core wiring**  
7 x 2.5 mm<sup>2</sup>  
3 separate circuits 2 control lines  
for DALI signal or one emergency light circuit

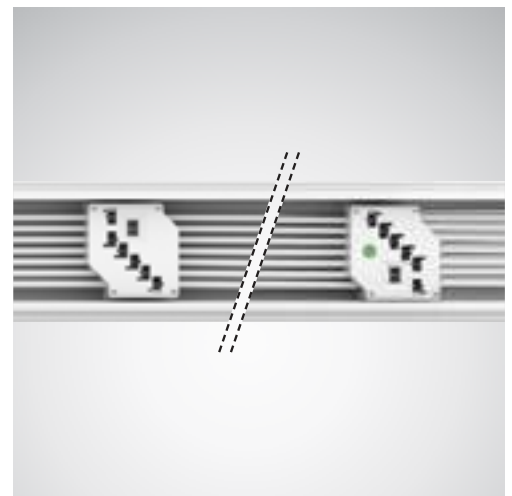

**7+7-core wiring**  
7 x 2.5 mm<sup>2</sup> + 7 x 2.5 mm<sup>2</sup>  
3 separate circuits  
2 control lines for DALI signal  
2 independent emergency light circuits (marked by green dot)



7-pole plug  
for infeed, rigid



7-pole plug  
for electronic contacting, flexible

### One less thing to worry about: Infeed as required

Requirements vary from application to application and from project to project. E-Line Next LED can be ideally integrated into various surroundings. No matter where the power supply is needed, the structural substance of the building remains unaffected thanks to flexible infeed options – be it from the front, at the coupling point or via break-out openings into the profile from above. Current infeed for E-Line Next LED with Fix trunking is possible with and without accessories.



Infeed from above



Front-side infeed

### Quick, clean and simple – intuitive and simple installation

Typical for E-Line Next LED is its quick, simple and intuitive installation. After fixing the grids, the gear trays are simply clicked into place without tools, using a spring lock. The new E-Line Next LED Fix gear trays with their contacts also fit into old E-Line trunking, both with LED versions and existing T5/T8 systems. This makes completing refurbishments fast, simple and low-effort.

**Coupling point** for mechanical and electrical trunking connection. The coupling is pre-assembled for quick and simple trunking connection. Infeed is possible at any coupling point.

A special feature of the Fix system: thanks to double-stacked cable routing, infeed can also be achieved without accessories!

When planning an IP64 continuous line, an allowance of 48 mm per coupling point must be factored in.

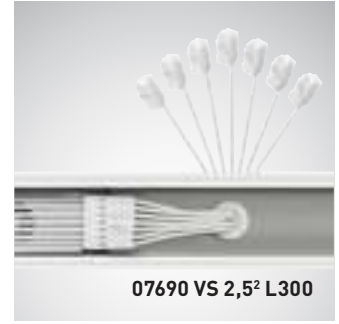

Cable 300 mm including plug terminal for central infeed.

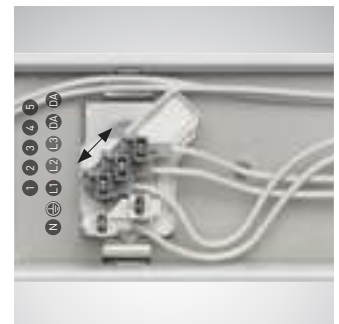
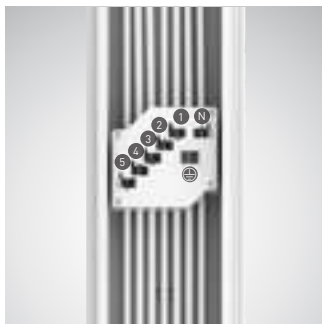

**Safety first:** Emergency lighting in buildings plays an increasingly important role. Due to people's sense of safety, but also to regulative requirements, the capability to react flexibly to requirements is essential.

**Fix Connector, switchable**

**Fix Connector, dimmable**

Fix	● 7-pole					● 7+7-pole								
	2.5 mm²					2.5 mm²								
	N	⊕	1	2	3	4	5	N	⊕	1	2	3	4	5
....7 ET	N	⊕	L1	L2	L3									
....7 ET NOT EB3/EB1	N	⊕	L1'	L2'	L3'		L1/2/3							
....7 ET NOT UR	N	⊕	L1	L2	L3	L1'	N1'							
....7 ETDD	N	⊕	L1	L2	L3	DA	DA							
....7+7.... ETDD & NOT EB3	N	⊕	L1'	L2'	L3'	DA	DA	⊕	L1	L2	L3			
....7+7.... ETDD & NOT EB1	N	⊕	L1'	L2'	L3'	DA	DA	N	⊕	L1	L2	L3	DA	DA
....7+7.... ETDD & NOT UR	N	⊕	L1	L2	L3	DA	DA	⊕	L1'	L2'			N1'	N2'

**ET/ETDD/UR**

N	Neutral conductor
⊕	Earthing conductor
L1	Phase 1
L2	Phase 2
L3	Phase 3
DA	DALI conductor
DA	DALI conductor
L1'	Supply UR 1
N1'	Supply UR 1
L2'	Supply UR 2
N2'	Supply UR 2

**ET/ETDD/EB1\*/EB3**

N	Neutral conductor
⊕	Earthing conductor
L1	Phase 1
L2	Phase 2
L3	Phase 3
DA	DALI conductor
DA	DALI conductor
L1'/L2'/L3'	switched phase EB3 / EB1*
L1/2/3	Charging phase EB3 / EB1*

\*Note on EB3 / EB1: Use same phase for general and emergency lighting  
 \* EB1 available as emergency light module (stand-by luminaire)

For further information, please refer to the installation instructions



**E-Line Flex** | 7-core | fully flexible wiring | IP20



①

**E-Line Flex** | 11-core | fully flexible wiring | IP20



②

The Flex system of the new E-Line Next LED has continuous wiring and thus enables modules to be freely positioned in the trunking. This guarantees maximum flexibility with lighting design. Thanks to the new trunking geometry and a new coupling, suspension distances of up to 4 metres can be achieved. This saves time and costs during mounting. The clips of the snap springs can also be easily removed after mounting. With its high quality, simple and purist design, E-Line Next LED also cuts an attractive figure in exclusive surroundings.



**E-Line Flex LED**  
Purist design

up to 4,000 mm suspension distance\*



\*Suspension distances vary depending on the type of luminaire insert/module.  
For more detailed information, please refer to the installation instructions.



11-core track system for flexible integration of additional modules and emergency lighting components  
Flex trunking available in 737.50 mm, 1,475 mm, 2,212.50 mm, 2,950 mm and 4,425 mm lengths



**Trunking connector**  
Mechanical coupling and  
electrotechnical connector  
pre-assembled in the trunking

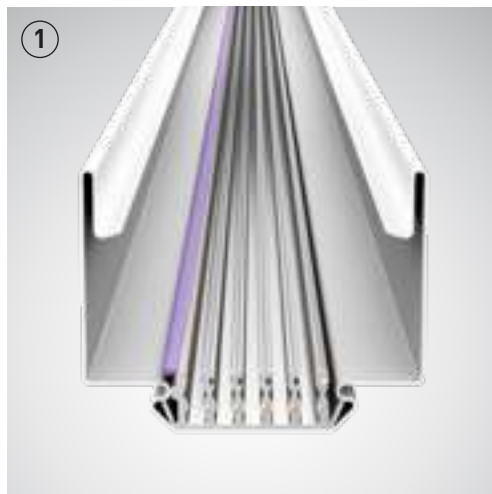

**7-core current conducting profile**  
 $5 \times 2.5 \text{ mm}^2 + 2 \times 1.5 \text{ mm}^2$   
3 separate circuits  
2 control lines for DALI signal



**11-core current conducting profile**  
 $5 \times 2.5 \text{ mm}^2 + 6 \times 1.5 \text{ mm}^2$   
3 separate circuits  
2 control lines for DALI signal  
2 independent emergency light circuits

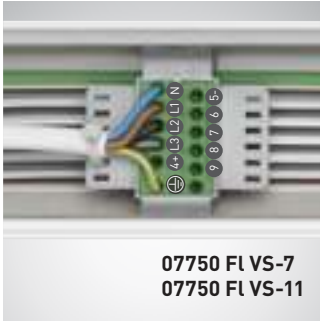

07750 Fl VS-7  
07750 Fl VS-11

7 or 11-pole plug for infeed,  
rigid



07750 VF-7  
07750 VF-11

7 or 11-pole plug  
for electronic contacting, flexible

### Infeed as simple as it gets

Current infeed for E-Line Next LED with Flex trunking is possible using various accessories. Be it from the front, from above into the trunking or also at the coupling points – there are (almost) no restrictions.

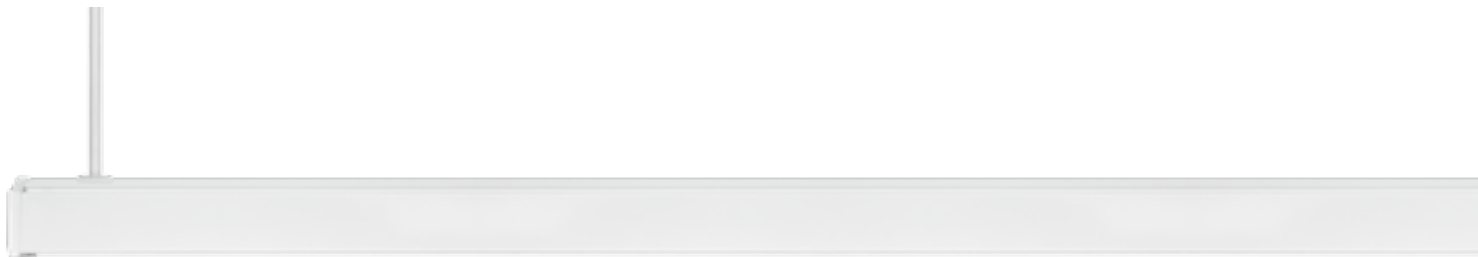

Infeed from above

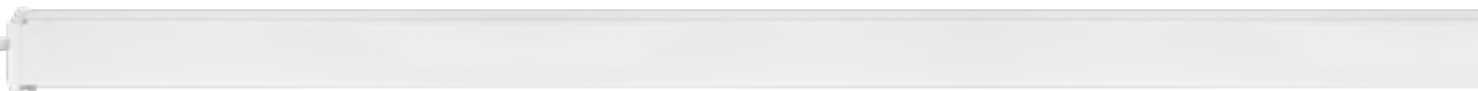

Front-side infeed

### Intuitive and flexible installation with optimised suspension distances

Typical for E-Line Next LED is its quick, simple and intuitive installation. After fixing the grids, the gear trays are simply clicked into place without tools, using a spring lock. One drilling point every four metres – a win by a large margin, since E-Line Next LED Flex features a new trunking geometry and a new type of coupling. It facilitates suspension distances of up to 4 metres. This saves significant amounts of time and costs during installation.

**Coupling point** for mechanical and electrical trunking connection. The coupling is pre-assembled for quick and simple trunking connection. Infeed is possible at any coupling point.

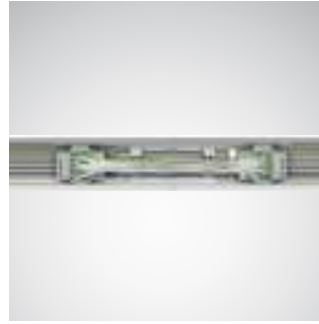

7 or 11-pole connector between trunking components, pre-assembled.



7 or 11-pole plug for central infeed at the coupling point.

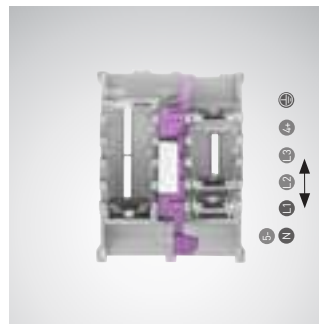
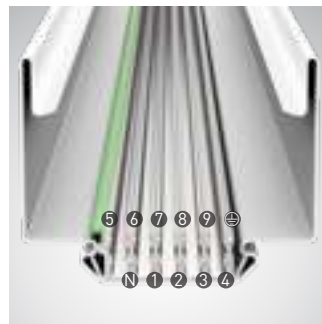

Flex connector, 7-core\*

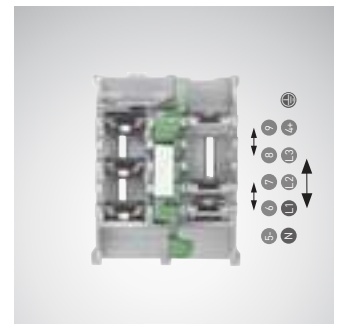

Flex connector, 11-core\*

Flex	● 11-poe										
	● 7-pole										
	2.5 mm <sup>2</sup>					1.5 mm <sup>2</sup>					
	N	⊕	L1	L2	L3	4+	5-	6	7	8	9
----7 ET	N	⊕	L1	L2	L3						
----7 ETDD	N	⊕	L1	L2	L3	DA	DA				
----11 ET NOT EB3 / EB1**	N	⊕	L1'	L2'	L3		L1/2/3			L2	L1
----11---- ETDD & NOT EB3 / EB1	N	⊕	L1	L2	L3	DA	DA			L2	L1
----11 ET NOT UR	N	⊕	L1	L2	L3			N2'	N1'	L2'	L1'
----11---- ETDD & NOT UR	N	⊕	L1	L2	L3	DA	DA	N2'	N1'	L2'	L1'

For further information, please refer to the installation instructions  
\* flexible manual phase selection option

#### ET/ETDD/UR

N	Neutral conductor
⊕	Earthing conductor
L1	Phase 1
L2	Phase 2
L3	Phase 3
DA	DALI conductor
DA	DALI conductor
L1'	Supply UR 1
N1'	Supply UR 1
L2'	Supply UR 2
N2'	Supply UR 2

\*\* Note EB3 / EB1: use same phase for general lighting and emergency lighting

#### ET/ETDD/EB1\*\*\*/EB3

N	Neutral conductor
⊕	Earthing conductor
L1	Phase 1
L2	Phase 2
L3	Phase 3
DA	DALI conductor
DA	DALI conductor
L1'/L2'/L3'	switched phase EB3 / EB1
L1/2/3	Charging phase EB3 / EB1

\*\*\* EB1 available as emergency light module (stand-by luminaire)

## E-LINE NEXT LED

GEAR TRAYS

### Opal optics

The two opal optics of E-Line Next LED feature a slender design. The diffuse covers prevent the LED dots from being seen and are therefore ideal for retail, office and education areas with mounting heights of 2.5 m to 4 m.

### ConVision® optics

With four specific light distributions, the ConVision® optics of E-Line Next LED are a real alternative for office and retail concepts. The unique lens technology, consisting of a two-part optical system, offers maximum quality of light as well as enormous freedom of design.

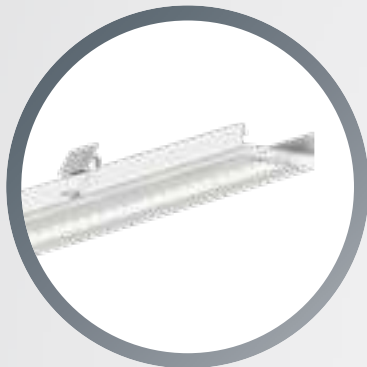

### Lens optics

With nine specific light distributions, the lens optics of E-Line Next LED are the ideal choice for every application and guarantee maximum illumination efficiency at mounting heights of 2.5 m to 16 m. A further plus: the lens optics have an identical appearance independent of the respective light distribution, thus ensuring a uniform ceiling appearance, especially in the retail sector.

### Further modules

Further additive elements such as sensor, emergency light, highbay, track and weather-proof luminaire modules as well as spotlights and light panels round off the portfolio and offer the complete range of options for individual lighting concepts.



















































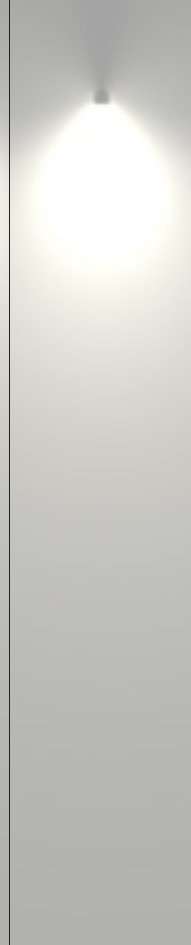

### Prismatic optics

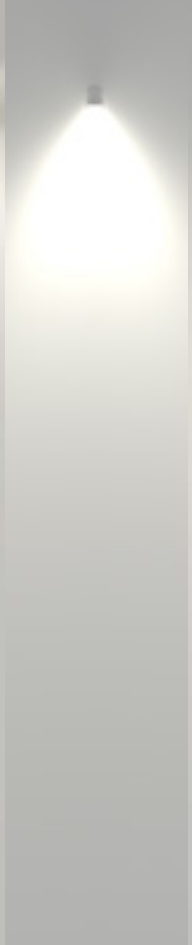
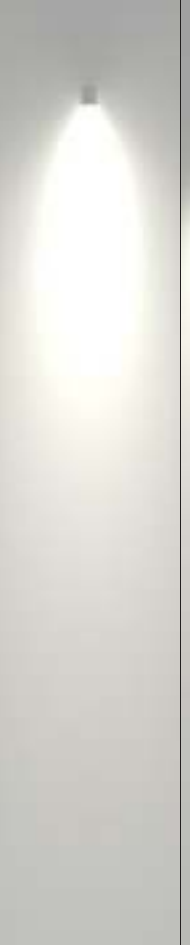

























Five different prismatic optics ensure optimum visual comfort and maximum quality of light in a wide range of applications. From quality assurance in the automotive industry to computer workstations in the office and education sectors, E-Line Next LED ensures uniform light without visible LED points at mounting heights from 2.5 m to 12 m.

# E-LINE NEXT LED OPTICS OVERVIEW

Lens							
<b>LVW</b> very wide distribution	<b>LW</b> wide distribution	<b>LN</b> narrow distribution	<b>LVN</b> very narrow distribution	<b>LEN</b> extremely narrow distribution	<b>LDAW</b> double asymmetric wide distribution	<b>LDAN</b> double asymmetric narrow distribution	<b>LAN</b> asymmetric narrow distribution
3 - 6 m Mounting height	4 - 8 m Mounting height	8 - 12 m Mounting height	8 - 12 m Mounting height	12 - 16 m Mounting height	2.8 - 3.5 m Mounting height	3.6 - 5.0 m Mounting height	2.8 - 3.5 m Mounting height

	Diffuser			Prismatic			
	   	   	   	   	   		   
<b>LW19</b> wide distribution (19)	<b>DL</b> Lambertian distribution	<b>DSL</b> narrow Lambertian distribution	<b>PWW</b> wide distribution	<b>PMW</b> medium wide distribution	<b>PW</b> wide distribution	<b>PVN</b> narrow distribution	<b>PW19</b> wide distribution (19)
							
2.8 - 3.5 m Mounting height	3 - 6 m Mounting height	2.5 - 4 m Mounting height	2.5 - 4 m Mounting height	2.5 - 8 m Mounting height	3 - 6 m Mounting height	8 - 12 m Mounting height	3 - 6 m Mounting height
							
							

 INDUSTRY  RETAIL  EDUCATION  OFFICE

ConVision® lens			
  	  	  	  
<b>CLW19</b> wide distribution (19)	<b>CLW22</b> wide distribution	<b>CLWW</b> wallwasher	<b>CLDAW</b> double asymmetric wide distribution
			
2.8 - 3.5 m Mounting height	2.8 - 5 m Mounting height	2.8 - 3.5 m Mounting height	2.8 - 3.5 m Mounting height
			
			
 RETAIL  EDUCATION  OFFICE			
IP20			

E-Line Next LED ConVision® is ideally suited for the retail, education and office sectors, providing best lighting efficiency and quality of light while being absolutely inconspicuous.

The innovative two-part ConVision® technology, with lens and light chambers, achieves a very pleasant lighting effect.

- best glare control with UGR<16 and UGR<19
- reduced disturbing multiple shadows
- no visible light on the ceiling
- highest perceptible quality of light
- excellent illumination

Four light distribution curves can be selected:

- wide distribution optic for optimum uniformity with UGR < 19 and L65 < 3000 cd/m<sup>2</sup> according to DIN 12464:2011
- wide distribution optic also with higher lumen packages and UGR<22
- asymmetric light distribution curve as wallwasher for blackboard illumination in the same design
- double asymmetric version for ideal illumination of shelf aisles in the retail sector

The light chambers are available as standard in three different colours – either white, silver or matt black. Other colours are also available on request, providing limitless scope for designing individual concepts.



**IDEAL FOR REFURBISHMENT PROJECTS**



**Fix Connector** In the 7+7-core version, the plug for electronic contacting of the emergency light circuits is marked with a green dot for easy assignment.

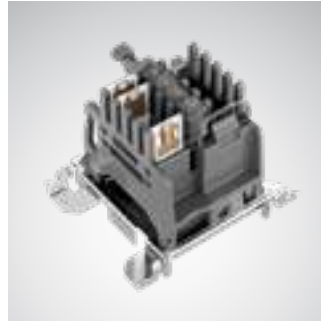

**Flex Connector** The plug for electronic contacting is colour coded: 7-core (purple) and 11-core (green).



**Snap springs**

A special feature of E-Line Next LED: the spring catch snaps into place after mounting and provides acoustic and visual feedback that it is correctly inserted. To ensure that the luminaire cannot be opened by unauthorised persons – for example in schools and educational establishments – the clips of the snap springs can be removed after installation.

The gear tray of E-Line Next LED is available in three different module lengths: 737.50 mm, 1475 mm and 2212.50 mm.



**737.50 mm**  
For more flexibility in planning.

**1475 mm**  
Ideal for refurbishment projects thanks to 1:1 replacement.

**2212.50 mm**  
For cost-efficient projects.

E-Line Next LED comes as standard with luminous flux packages of between 2,000 and 20,000 lm. The luminous flux packages up to 10,000 lm can be flexibly selected in steps of 500 lm. Between 10,000 and 20,000 lm, luminous flux packages can be configured in steps of 1,000 lm. This means that warehouses with high mounting heights can be illuminated just as effortlessly and efficiently as offices, supermarkets and educational facilities.



E-Line Next LED is available with 15 different optics and spotlights. This means it always achieves optimum visual comfort in any application and at any mounting height, and at the same time offers complete flexibility for accenting and emotional light.



**Lens optic**



**Prismatic optics**



**Opal optics**

## E-LINE NEXT LED

### REFURBISHMENT



E-Line Next LED can be easily retrofitted 1:1 onto existing old systems. Converting a conventional T5/T8 E-Line to LED technology, for example, takes just 44 seconds and brings many advantages:

- 1:1 exchange of the gear tray
- tool-free
- best efficiency in combination with maximum service life
- more well-being, more safety and more quality of light
- optimised packaging concepts

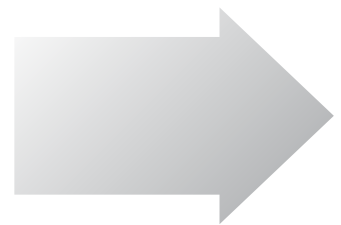

#### **Starting signal for best efficiency.**

Ideal preconditions for refurbishments: the E-Line Next continuous line system can be quickly and efficiently integrated into existing T5 and T8 E-Line trunking.

#### **Removal made easy.**

Disassembly without tools. Accessory components of the existing luminaire insert (reflector, louvres, connectors etc.) are disassembled without tools. The trunking is now ready to accommodate the LED module.

# REFURBISHMENT

	Old system	New system	
	T8/1 x 58 W	E-Line Next	Savings*
<b>CCG</b>	75 W	29 W	<b>-61%</b>
<b>LLCG</b>	70 W	29 W	<b>-59%</b>
<b>ECG</b>	55 W	29 W	<b>-47%</b>

  

	T8/2 x 58 W	E-Line Next	
<b>CCG</b>	150 W	48 W	<b>-68%</b>
<b>LLCG</b>	140 W	48 W	<b>-66%</b>
<b>ECG</b>	110 W	48 W	<b>-56%</b>

\*Up to 30% more possible with use of light management systems (based on electricity consumption during operation).

## How much is your savings potential?

Calculate the cost saving potential for your lighting solution by using our Efficiency Calculator on the Internet at [www.trilux.com/effizienz-rechner](http://www.trilux.com/effizienz-rechner). Or simply ask your contact person for an efficiency calculation.

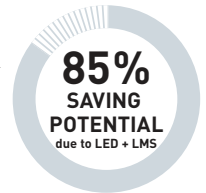

From old to new during running operation – experience the lighting refurbishment at Wache Lübeck GmbH

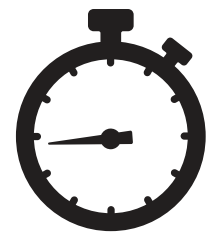
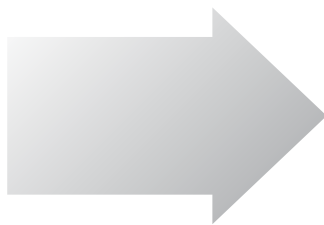

### With a single click. Integrating new optics.

A new optic can be simply clicked into the existing trunking rail without tools and thanks to the intelligent spring catch construction. The module is firmly clicked in if the spring terminals protrude forward slightly on both sides.

### New light in old trunking rails.

An attractive and highly efficient lighting solution with customised optics. With up to 190 lm/W and a service life of up to 100,000h

### From old to new in just 44 seconds

# E-LINE NEXT LED

## MODULE OVERVIEW



1 LiveLink module



2 Sensor modules



3 Universal module (blind)



4 Lightpanel G2 LED



5 Grado LED/B.Veo LED/Lenty Plus LED



6 3-circuit track modules

In addition to the standard gear trays, E-Line Next LED can also be combined with other modules such as spotlights and emergency light components.

- 1** Optimum, individually adapted light with minimum complexity – achieved thanks to the intuitive and reliable control of all light points. The easy-to-install, intelligent LiveLink WiFi module (368.75 mm module length) makes it possible to easily plan and operate the control of even complex lighting installations. Thanks to the plastic cover, secure connection and better range are guaranteed. Exceedingly fast integration into the trunking via plug & play. Reduce energy costs quickly and easily.
- 2** The daylight and presence sensors (for various installation heights) are mounted on a factory pre-assembled gear tray (module length 368.75 mm) and are simply put into operation via plug & play.
- 3** Universal module (blind) with 5-pole tap for flexible integration of additional components such as cameras, loudspeakers, other sensors, etc. Simple power supply via plug & play.
- 4** The versatile Lightpanel G2 LED with its high quality and particularly energy-efficient light provides attractive general lighting and route guidance in the retail sector, and can be simply inserted into the E-Line Next LED trunking system (module length 737.50 mm).
- 5** The three spotlights B.Veo LED, Grado LED and Lenty Plus LED offer various accentuation options for the retail sector. With its specially developed diffuser reflector, the Grado LED graphic spotlight provides optimally uniform light for graphics, displays or visuals, while the B.Veo LED with its five different beam angles guarantees perfect accenting of the merchandise. With lens technology, Lenty Plus LED enables targeted focussing of goods and ensures ideal contrasts with various application-specific light distributions. Pre-assembled on a 368.75 mm module, they can be easily implemented in an E-Line Next LED trunking system. Thanks to a wide range of lumen packages (2000-5000 lm), the spotlights can be used at diverse mounting heights. The six white light colours and three special light colours for fresh food areas also provide the right light for any merchandise group.
- 6** 3-circuit track modules from Nordic (module length 1,475 mm), optionally available for switchable and dimmable spotlights. Simple, tool-free mounting. Ideal for accentuating merchandise in the retail sector.

# E-LINE NEXT LED

## MODULE OVERVIEW



7 Nextrema G3 LED



8 Oleveon Fit/Aragon Fit LED adapter

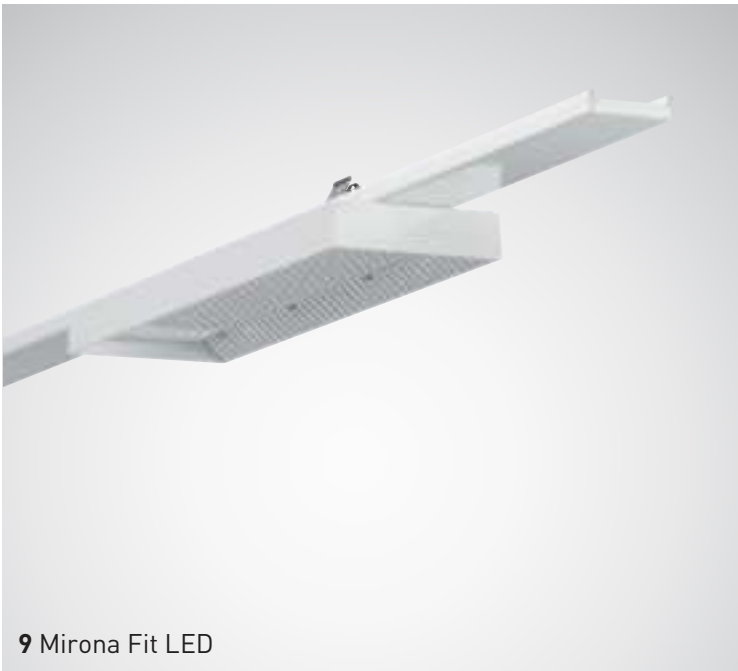

9 Mirona Fit LED



10 L, T and X-connector



11 Emergency light module

- 7 Whether for cold stores, food production, logistics halls or car parks – the Nextrema G3 LED emits pleasantly uniform, glare-free light, and in operation not only saves costs but keeps operations going in the long run thanks to high reliability. Thanks to the adapter (module length 1,475 mm), integration into E-Line Next trunking is very simple via plug & play.
- 8 Olevion Fit LED/Aragon Fit LED raises the lighting quality in damp rooms to a new level. Innovative 3-D prismatic technology provides uniform, glare-free light and state-of-the-art LED technology minimises energy consumption. The same applies here: very easy integration into the trunking (module length 1,475 mm) and quick electrical connection of the luminaire ensure best light even in environments with higher protection requirements.
- 9 In addition to the classic gear trays, the Mirona Fit LED highbay spotlight can also be inserted into E-Line Next LED trunking (1475 mm or 2212.50 mm module length). In this way, special applications such as halls with particularly high ceilings or extreme temperatures can be equipped.
- 10 Becoming one with the architecture: E-Line Next LED can be joined and combined into numerous variants by use of various connectors – completely according to the respective design and photometric requirements.

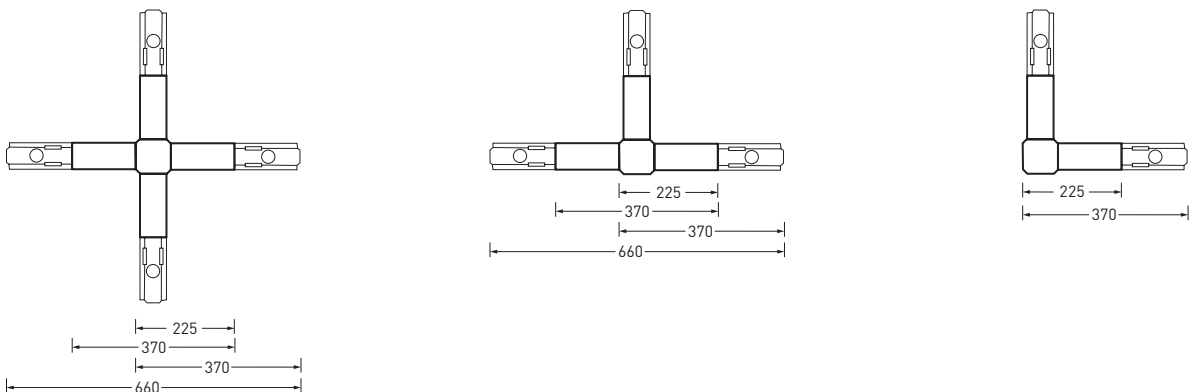

- 11 Emergency light module (INOTEC) for marking escape and rescue routes with two different ranges: 20 m and 30 m. Can be swivelled in 45° steps. Simple plug & play integration into E-Line Next LED for integrating in inotec 230 V and 24 V emergency lighting systems.



## E-LINE NEXT LED

### EMERGENCY LIGHT

In addition to the general lighting of a building, safety lighting is also required in almost every building project. It becomes effective for a defined time if the artificial lighting in a building fails. Safety lighting is required, among other areas, in the fire protection concept, building law (state building regulations etc.), occupational safety law and accident prevention law. As a rule, battery-supported systems are used as a power source for safety purposes, which are intended to achieve the following protection goals:

- **leaving a building safely in the event of a general power supply failure**
- **the safe termination of potentially hazardous work processes**
- **locating fire-fighting and safety facilities (e.g. the first aid point)**

In the area of escape and rescue route lighting, E-Line Next LED offers a solution optimised for safety lighting.

The **E-Line Next LED with single supply unit (single battery)** is additionally connected to the unswitched outer conductor and the neutral conductor. This way, the integrated battery is charged and the mains function with charge control is monitored independently of the luminaire's switch-on state. A separate mains for the safety power supply can be omitted. In case of failure of the general power supply, an LEDM of the luminaire for mains operation is supplied with the energy of the single battery for emergency lighting in non-maintained operation. The charging control goes out.

## Single battery EB3

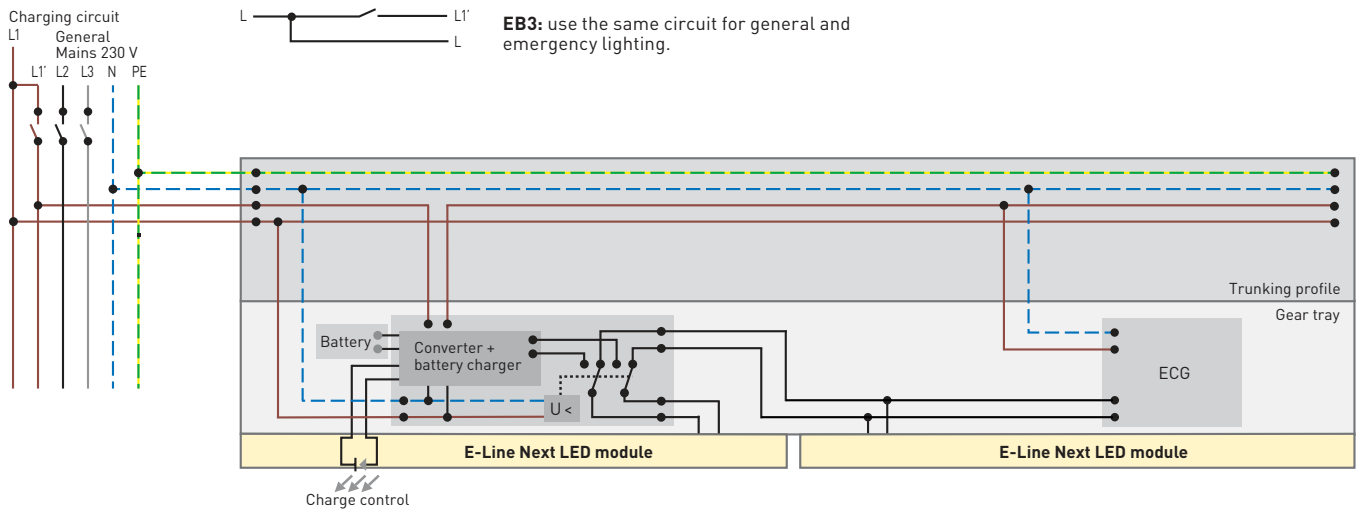

## Central battery with changeover relay

The **E-Line Next LED with changeover relay in maintained and non-maintained operation.**

In case of failure of the general power supply, the safety power supply is switched on with 220 V direct voltage or with 230 V alternating voltage due to the voltage monitoring, e.g. in central or group battery systems. The luminaire for mains operation continues to operate with the energy of the battery system.

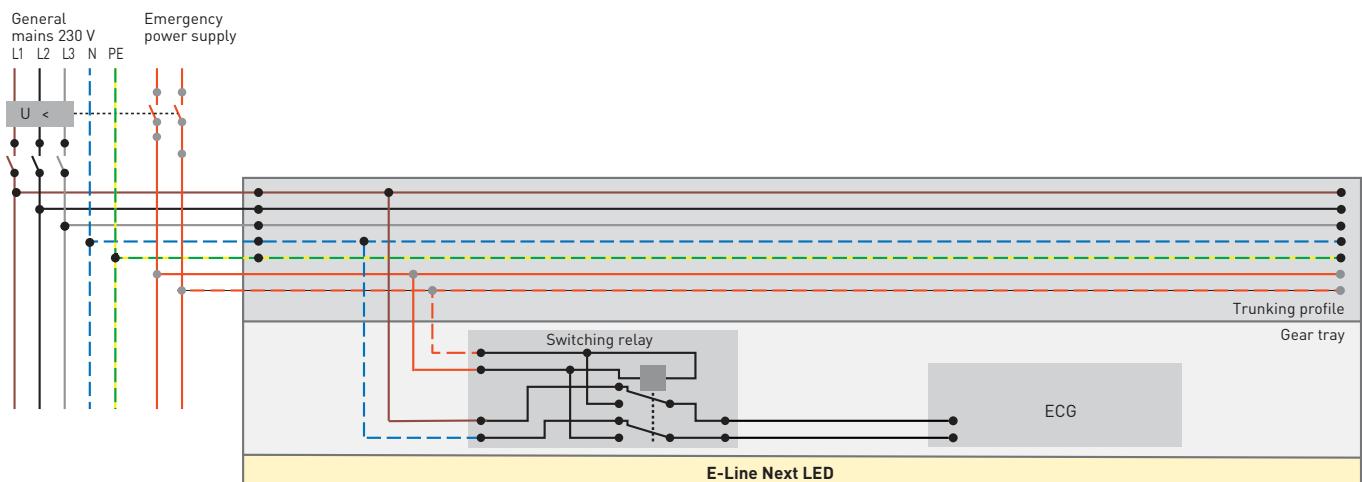

# EMERGENCY LIGHT

The **emergency light modules for E-Line Next LED** are connected to both the general mains and the safety power supply. In case of failure of the general power supply, the safety power supply is switched on due to the voltage monitoring, e.g. in central or group battery systems. The module with integrated ECG is supplied independently of the mains. Depending on the type of safety power supply, the luminaire is operated in maintained or non-maintained operation.

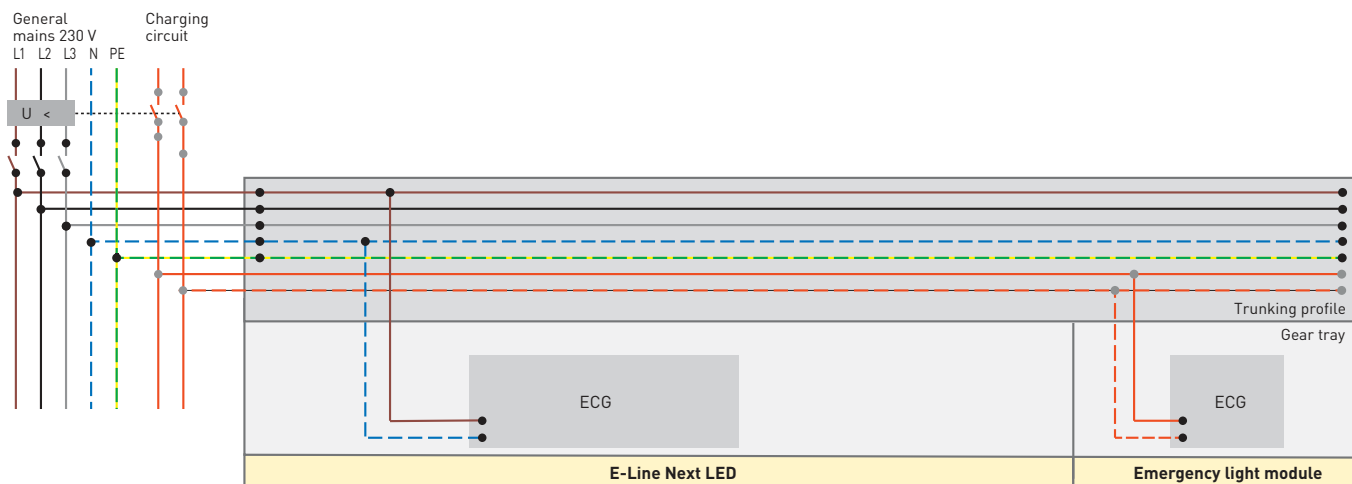

## Single battery (EB1/EB3) / central battery with changeover relay

Module length	Beam angle	Switching	Type of emergency light	Luminous flux (lm/% of luminaire luminous flux)	illuminated unit
Single battery (EB1)					
L75	straight to E-Line Next optic	ET	EB1	100% (standby luminaire)	All LEDM
L75	straight to E-Line Next optic	ETDD	EB1	100% (standby luminaire)	All LEDM
Single battery (EB3)					
L150	straight to E-Line Next optic	ET	EB3	414 lm	1 LEDM
L150	straight to E-Line Next optic	ETDD	EB3	414 lm	1 LEDM
L225	straight to E-Line Next optic	ET	EB3	414 lm	1 LEDM
L225	straight to E-Line Next optic	ETDD	EB3	414 lm	1 LEDM
Central battery with changeover relay					
L150	straight to E-Line Next optic	ET	UR	100%	All LEDM
L150	straight to E-Line Next optic	ETDD	UR	15%	All LEDM
L225	straight to E-Line Next optic	ET	UR	100%	All LEDM
L225	straight to E-Line Next optic	ETDD	UR	15%	All LEDM
L225	straight to E-Line Next optic	ET	UR	100%	All LEDM

### Note:

All switchable gear trays (ET) have 100% in DC operation.  
 All dimmable gear trays (not UR / EB1 / EB3) have 15% in DC operation.  
 Does not apply to EB1, EB3 or UR variants.

## Central battery with emergency light module (INOTEC/CEAG)

The E-Line Next LED emergency light modules are used in combination with INOTEC 230V or 24V/ CEAG 230V emergency lighting systems. In general, the module can be combined with the trunking of the Fix variant (7LV + 7LV) or the Flex variant (11-pole) via the familiar snap fasteners. The optimised light distribution of the optical system guarantees safe illumination of escape routes at different mounting heights (from 2.5 m to 12 m).

# EMERGENCY LIGHT



	Escape routes		Areas	
	Asymmetric Low Bay (ALB)	Asymmetric High Bay (AHB)	Symmetric Low Bay (SLB)	Symmetric High Bay (SHB)
Mounting height recommendation	2.5 - 6 m	2.5 - 12 m	2.5 - 6 m	2.5 - 12 m

Module length	Beam angle	Type of emergency light	Luminous flux (lm/% of luminaire luminous flux)	illuminated unit	compatible with emergency lighting systems (V)
L37 Inotec	ALB	UR	139 lm	Light of emergency light module	24 V/230 V
L37 Inotec	SLB	UR	322 lm	Light of emergency light module	24 V/230 V
L37 Inotec	AHB	UR	287 lm	Light of emergency light module	24 V/230 V
L37 Inotec	SHB	UR	545 lm	Light of emergency light module	24 V/230 V
L37 CEAG	ALB	UR	250 lm	Light of emergency light module	230 V
L37 CEAG	SLB	UR	250 lm	Light of emergency light module	230 V
L37 CEAG	AHB	UR	282 lm	Light of emergency light module	230 V
L37 CEAG	SHB	UR	282 lm	Light of emergency light module	230 V

SLB = Symmetric Low Bay, SHB = Symmetric High Bay, ALB = Asymmetric Low Bay, AHB = Asymmetric High Bay

	INOTEC	CEAG
<b>Luminous flux (lm)</b>	216 lm 288 lm 364 lm 476 lm	250 lm 282 lm
<b>Connected load</b>	4 W	2 W 3.9 W
<b>Light colour</b>	4,000 K	6,500 K
<b>IP</b>	IP20   IP50 compatible with IP64	IP20 compatible with IP64
<b>Temperature</b>	-15 °C to +45 °C	-20 °C to +40 °C
<b>Colour</b>	white	white

## Rescue and escape route marking (INOTEC)

Versatile LED escape sign panel luminaire with frameless pictogram panel. Uniform pictogram illumination thanks to modern fibre optic technology. Slim housing made of white UV- and glow wire-resistant polycarbonate for easy integration into E-Line Next.



Detection range	20 m, 30 m
IP	IP20
Light colour	6500 K
Light source	12 x 0.1W LED module
Temperature	-15 °C to +40 °C
Colour	white, black, silver
Alignment	in 45° steps
Pictograms	9 different arrow directions

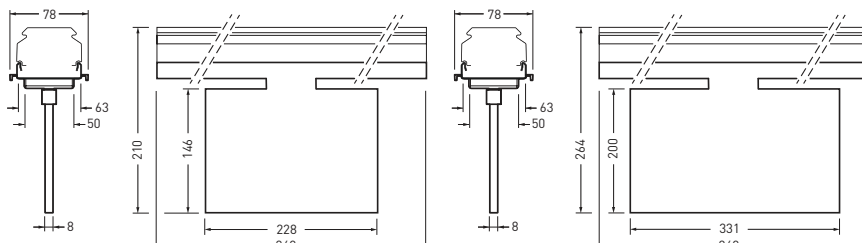

E-LINE NEXT LED

TECHNICAL FEATURES



**NEXT**

EVERYTHING REMAINS. **EXCEPT BETTER.**

Features	E-Line Fix	E-Line Flex
Energy efficiency	to 170 lm/W HE; HE+ (Industry) to 190 lm/W	
Individually configurable luminous flux packages	2,000 lm to 20,000 lm 2,000-10,000 lm: steps of 500 lm 10,000-20,000 lm: steps of 1,000 lm	
Service life	50,000 h / L80 / tq 35 °C HE 70,000 h / L80 / tq 50 °C HE+ (Industry) 100,000 h / L80 / tq 50 °C	
Colours	white 01 silver 03* black 05	
Colour rendering	Ra > 80 HE; HE+ (Industry) Ra > 80/90 / ACT	
Optics (HCL-capable)	9 lens optics 4 ConVision® optics 2 opal optics 5 prismatic optics	
Wiring (LV)	7 / 14	7 / 11
Protection rating	IP20 / IP64 / IP50	IP20
Module sizes	Module 750: 738 mm Module 1500: 1,475 mm Module 2250: 2,212.50 mm	
Ambient temperature	-25 °C to 35 °C HE; HE+ (Industry) -25 °C to 50 °C	
Suspension distances	up to 3.5 m	up to 4.0 m
Mounting method	Surface- and suspended mounting using various fasteners	
Further features	Spotlight-, track-, sensor-, light management-, emergency light- and blank module inserts, and light panel-, fixed point-, weather-proof luminaire-, MironaFit- and X-T-L connectors (NN) and much more	

HE = High Efficiency  
HE+ = High Efficiency (Industry)  
\* IP64 variant in silver as standard

**Note:**  
All switchable gear trays (ET) have 100% in DC operation.  
All dimmable gear trays (non-UR/EB1/EB3) have 15% in DC operation.  
Does not apply to EB1, EB3 or UR versions.

#### Maximum quantity of gear trays per circuit for various automatic circuit breakers

Cable cross-section	Fusing	Automatic circuit breaker	Number of gear trays on one circuit*
2.5 mm <sup>2</sup>	16 A	Type B	12 - 32 pcs.
2.5 mm <sup>2</sup>	16 A	Type C	20 - 54 pcs.
1.5 mm <sup>2</sup>	10 A	Type B	7 - 19 pcs.
1.5 mm <sup>2</sup>	10 A	Type C	12 - 32 pcs.

\* please refer to the data sheet for the exact number of gear trays per circuit

<b>765</b>	<b>1</b>	<b>IP</b>	<b>ACT</b>	<b>HE+</b>	<b>LW</b>	<b>-05</b>
------------	----------	-----------	------------	------------	-----------	------------

Product name	Protection rating IP50 – optional	Active (optional)	Performance	Optic	Colour of light chamber (only with ConVision®)
<b>7751-Flex</b> <b>7651-Fix**</b>	Optional, protection rating IP50 all-round only with Fix 7651 IP  <b>IP50</b> For applications with increased requirements and for use in operating areas exposed to fire hazards (D designation)	Optional, Active, HCL Active (CRI80 2700 K - 6500 K)  High colour rendering, individually settable, natural and activating light colour (DT8)	<b>Without HE-</b> Entry <b>HE</b> - Core <b>HE+</b> - Core  <b>Entry</b> 50,000 h <b>Core</b> 70,000 h <b>HE+</b> 100,000 h	see below	<b>01</b> white <b>03</b> silver <b>05</b> black

\* 1 – stands for a 1-row luminaire insert, \*\* 7651FIX LW 20k840 L150 ETDD 01, nomenclature of refurbishment insert

## Optic



### D... Diffuse optics

**DL**



Diffuser Lambertian  
Lambertian distribution optic  
Indirect component approx. 13 %  
Mounting heights 2.5-4.0 m

**DLS**



Diffuser Lambertian Slim  
Lambertian distribution optic  
Indirect component approx. 13 %  
Mounting heights 2.5-4.0 m



### CL... ConVision® optics

**CLW19**



ConVision® lens wide (UGR<19)  
Wide distribution optic UGR<19 (up to 3,000 lm/m)  
Mounting heights 2.8-3.5 m

**CLW22**



ConVision® lens wide (UGR<22)  
Wide distribution optic  
Mounting heights 2.8-5 m

**CLWW**



ConVision® lens wallwasher  
Asymmetric wide distribution optic  
Mounting heights 2.8-4 m

**CLDAW**









ConVision® lens double asymmetric wide  
Double asymmetric wide distribution optic  
Mounting heights 2.8-3.5 m

200	840	ETDD	EB3	L225	01	p6
System luminous flux	Light colour/CRI	Switching type	Emergency light	Length Luminaire insert	Housing colour	Packing, optional
<b>20-100</b> 2,000 - 10,000 lm freely configurable in 500 lm steps  <b>100-200</b> 10,000 - 20,000 lm freely configurable in 1,000 lm steps	<b>830</b> 3000 K, CRI80 <b>835</b> 3500 K, CRI80 <b>840</b> 4000 K, CRI80 <b>850</b> 5000 K, CRI80 <b>865</b> 6500 K, CRI80 <b>930</b> 3000 K, CRI90 <b>935</b> 3500 K, CRI90 <b>940</b> 4000 K, CRI90 <b>950</b> 5000 K, CRI90 <b>965</b> 6500 K, CRI90	<b>ET</b> switchable <b>ETD8</b> dimmable DT8 (ACT) <b>ETDD</b> dimmable <b>ETBLE</b> Bluetooth Low Energy	<b>EB3</b> Single battery 3h <b>UR</b> Central battery	<b>L75</b> 737.50 mm <b>L150</b> 1475 mm <b>L225</b> 2212.50 mm	<b>01</b> white <b>03</b> silver <b>05</b> black	<b>optional</b> simple - n.a. <b>p4</b> package of 4 <b>p6</b> package of 6 <b>p8</b> package of 8 <b>p10</b> package of 10

## Optics









### L... Lens optics

<b>LVW</b>		Lens Very Wide Very wide distribution optic Mounting heights 3-6 m
<b>LW</b>		Lens Wide Wide distribution optic Mounting heights 4-8 m
<b>LN</b>		Lens Narrow Narrow distribution optic Mounting heights 4-8 m
<b>LVN</b>		Lens Very Narrow Very narrow distribution optic Mounting heights 8-12 m
<b>LEN</b>		Lens Extreme Narrow Extremely narrow distribution optic Mounting heights 12-16 m
<b>LW19</b>		Lens Wide (19) Wide distribution optic UGR<19 (to 3,000 lm/m), mounting heights 3-6 m
<b>LDAN</b>		Lens Double Asymmetric Narrow Double asymmetric narrow distribution optic Mounting heights 3.6-5.0 m
<b>LAN</b>		Lens Asymmetric Narrow Asymmetric narrow distribution optic Mounting heights 2.8-3.5 m
<b>LDAW</b>		Lens Double Asymmetric Wide Double asymmetric wide distribution optic Mounting heights 2.8-3.5 m



### P... Prism optics

<b>PW</b>		Prismatic Wide Wide distribution optic Indirect component approx. 8 % Mounting heights 3-6 m
<b>PVN</b>		Prismatic Very Narrow Narrow distribution optic Indirect component approx. 8 % Mounting heights 8-12 m
<b>PWW</b>		Prismatic Wide Wide Wide distribution optic Indirect component approx. 28 % Mounting heights 2.5-4.0 m
<b>PW19</b>		Prismatic Wide (19) Wide distribution optic UGR<19 (to 3,000 lm/M) VDU workstation-compliant Indirect component approx. 8 % Mounting heights 3-6 m
<b>PMW19</b>		Prismatic Medium Wide (19) Wide distribution optic UGR<19 (up to 8,000 lm/L150) Suitable for VDU workstations Indirect component approx. 28 % Mounting heights 3-6 m
<b>PMW22</b>		Prismatic Medium Wide (22) Wide distribution optic Indirect component approx. 38 % Mounting heights 4-8 m

The background is a complex, blue-toned pattern that resembles a microscopic view of a crystalline material or a highly detailed geometric structure. The pattern consists of numerous interconnected, angular shapes that create a sense of depth and texture. The colors range from deep, dark blues to lighter, more vibrant blues, with some areas appearing to have a slight sheen or reflection. The overall effect is one of intricate, organic complexity.

EVERYTHING REMAINS.

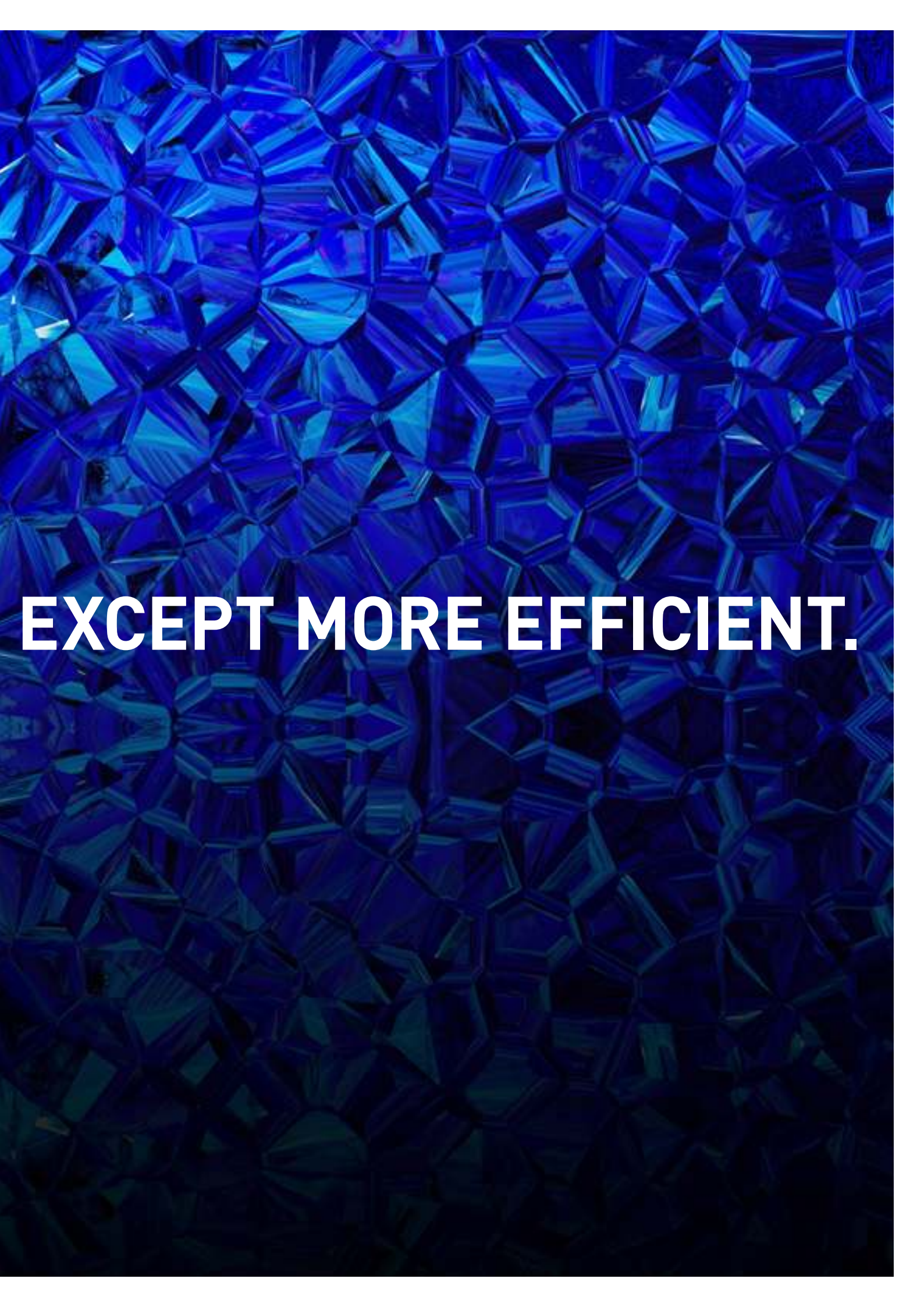

**EXCEPT MORE EFFICIENT.**

## E-LINE NEXT LED

INDUSTRY  
PLANNING EXAMPLES



Whether highbay racking warehouses or dispatch halls, E-Line Next LED with its versatile optics always offers the right solution for every application in the logistics sector as well.

## HIGHBAY RACKING

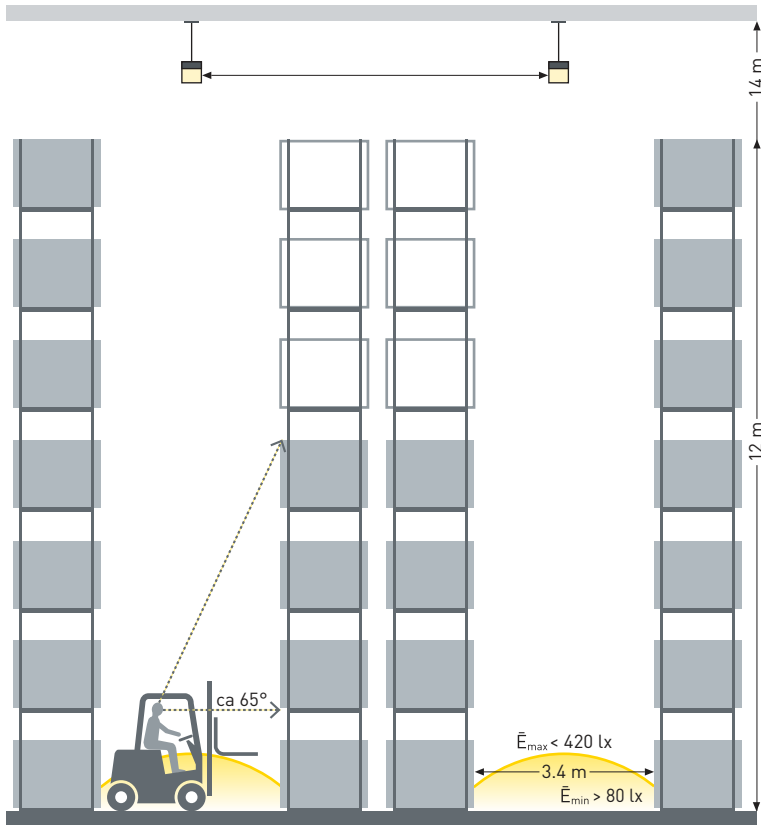

### Basis for planning example:

Aisle width.....3 m to 3.5 m  
 Mounting height..... 14 m (12 – 16 m)  
 E-Line lumen package.....variable  
 Vertical illumination.....0.5 m to 12.5 m

### Normative requirement

$\bar{E}_m > 150 \text{ lx} - U_o > 0.40$



LEN

## WAREHOUSE

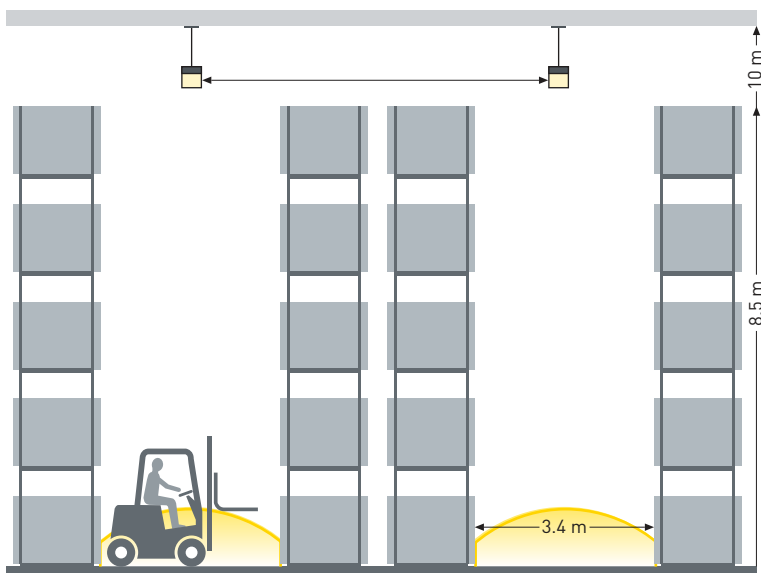

### Basis for planning example:

Aisle width.....3 m to 3.5 m  
 Mounting height..... 8 – 12 m  
 E-Line lumen package.....variable  
 Vertical illumination.....0.5 m to 8.5 m

### Normative requirement

$\bar{E}_m > 150 \text{ lx} - U_o > 0.40$



LVN

# E-LINE NEXT LED

INDUSTRY  
PLANNING EXAMPLES



E-Line Next LED offers the optimum solution for every normative requirement and ceiling height in industrial production halls. Individually selected luminous flux also guarantees maximum visual comfort and maximum efficiency. When planning an IP64 continuous line, an allowance of 48 mm per coupling point must be factored in.

### ASSEMBLY WORKPLACE

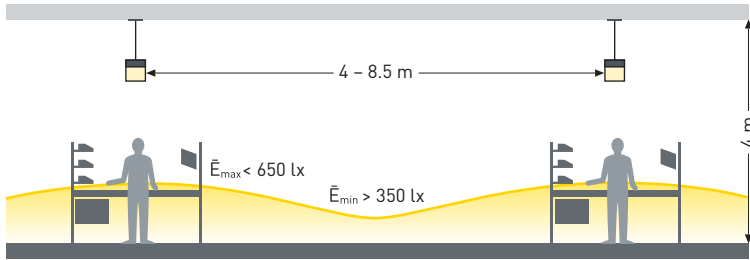

**Basis for planning example:**

Mounting height ..... 4 m (2.5 m-5 m)  
 E-Line lumen package ..... variable  
 Industrial hall ..... 120 m x 60 m

**Normative requirement**

$\bar{E}_m \geq 500 \text{ lux} - U_o \geq 0.60$



### PRODUCTION HALL

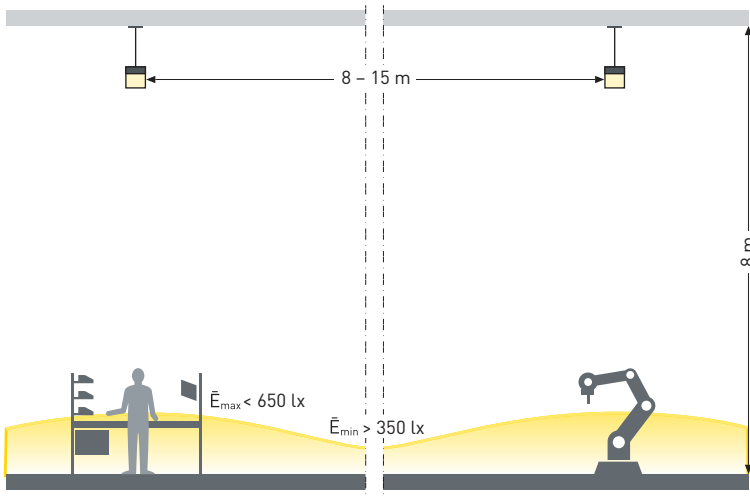

**Basis for planning example:**

Mounting height ..... 8 m (6 m-10 m)  
 E-Line lumen package ..... variable  
 Industrial hall ..... 120 m x 60 m

**Normative requirement**

$\bar{E}_m > 500 \text{ lx} - U_o > 0.60$



### HEAVY INDUSTRY PRODUCTION HALL

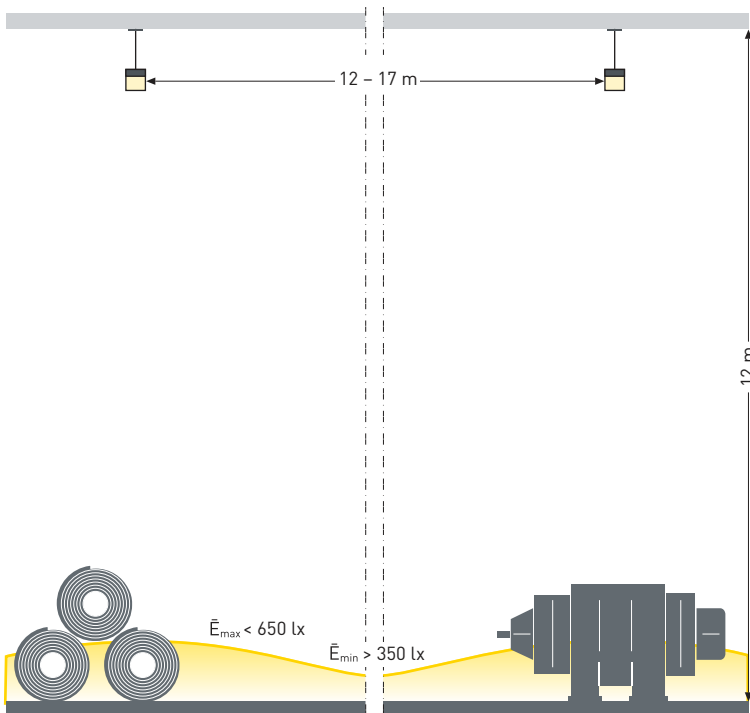

**Basis for planning example:**

Mounting height ..... 12 m (>10 m)  
 E-Line lumen package ..... variable  
 Industrial hall ..... 120 m x 60 m



## E-LINE NEXT LED

RETAIL  
PLANNING EXAMPLES



Continuous lines flexibly and efficiently display merchandise in aisles. Increased illuminance at customer eye level is particularly important. In this way, merchandise can be specifically accentuated with light. The use of spotlights additionally emphasises this effect.

## MERCHANDISE AISLE

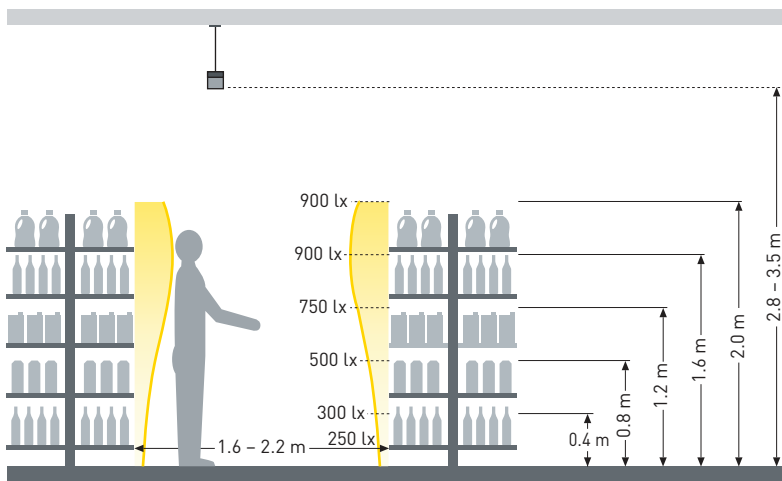

### Basis for planning example:

Aisle width..... 1.9 m  
 Mounting height..... 3.0 m  
 E-Line lumen package..... 4,400 lm/m



LD AW



CL DA W

## AISLE WITH SPOTLIGHTS

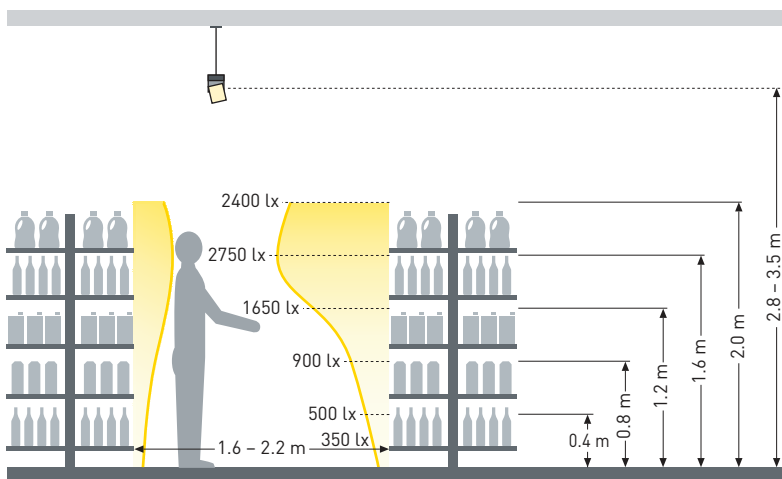

### Basis for planning example:

Aisle width..... 1.9 m  
 Mounting height..... 3.0 m  
 E-Line lumen package..... 4,400 lm/m



LD AW



MF



### E-Line Next LED with ETBLE

The requirements placed on a modern lighting control system are diverse. From the emotionalisation of small areas at the point of sale to light management for buildings, each area in the store requires its own personal solution.

Learn more at: [www.oktalite.com/led-iq](http://www.oktalite.com/led-iq)

## E-LINE NEXT LED

RETAIL  
PLANNING EXAMPLES



Long working days, stressed customers and high concentration: at checkout areas, E-Line Next LED offers maximum visual comfort with a UGR value of 19. These are the best prerequisites for efficient workplaces.

## CHECKOUT AREA

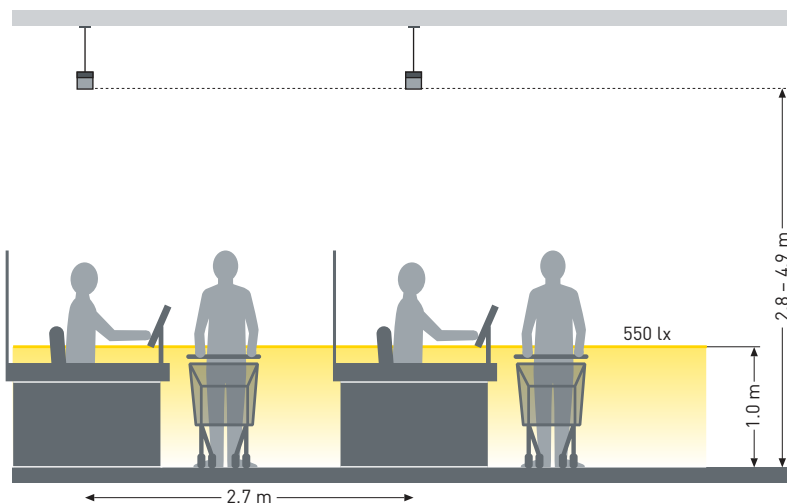

### Basis for planning example:

Aisle width.....	2.70 m
Mounting height.....	3.50 m
E-Line lumen package.....	2,400 lm/m
UGR .....	suitable for computer workstations

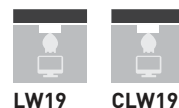

# E-LINE NEXT LED

OFFICE  
PLANNING EXAMPLES



Changes in the worlds of work has led to innovative New Work concepts in addition to classic offices. The E-Line Next LED continuous line ensures efficient illumination of the office area whilst also offering outstanding quality of light thanks to high colour rendering and Human Centric Lighting. Spotlight modules can also be flexibly installed to accent or zone specific areas.

## CLASSIC OFFICE

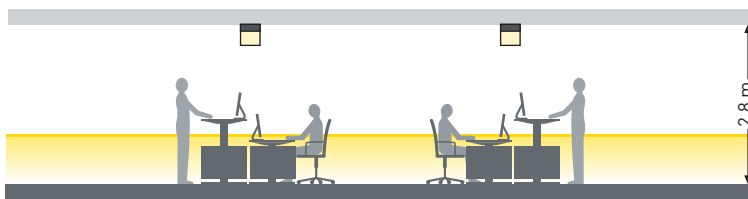

### Basis for planning example:

Mounting height (PW19) ..... 2.8 m (2.5 m-5 m)  
 Mounting height (recommendation: LW19) ..... > 3.5 m  
 E-Line lumen package (L 2.25 m) ..... 6,600 lm  
 UGR ..... ≤ 19

### Normative requirement

$\bar{E}_m \geq 500 - 1,000 \text{ lux} - U_o \geq 0.60$



PW19  
LW19



CLW19

## INDUSTRIAL DESIGN OFFICE

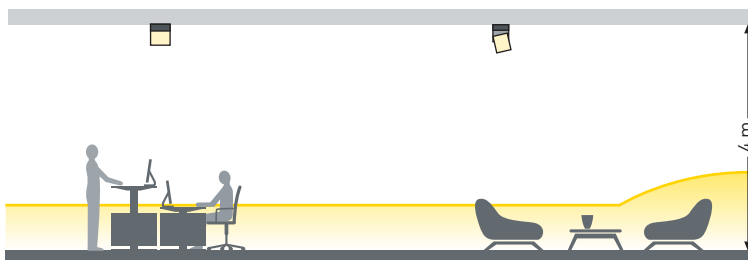

### Basis for planning example:

Mounting height (PW19) ..... 4 m (2.5 m-5 m)  
 Mounting height (recommendation: LW19) ..... > 3.5 m  
 E-Line lumen package (L 2.25 m) ..... 6,600 lm  
 UGR ..... ≤ 19

### Normative requirement

$\bar{E}_m \geq 500 - 1,000 \text{ lux} - U_o \geq 0.60$



PW19  
LW19



MF  
SP

# E-LINE NEXT LED

EDUCATION  
PLANNING EXAMPLES



Good visibility is required to create a good learning and teaching atmosphere in classrooms and auditoriums. E-Line Next LED ensures efficient illumination of the room, and with its asymmetric optic focuses on the teaching content on panels and blackboards. Thanks to outstanding quality of light, high colour rendering and good glare control, best conditions for successful learning are achieved.

## CLASSROOM

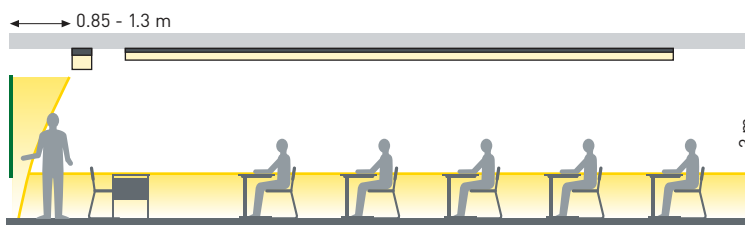

### Basis for planning example:

Mounting height (usually) .....	3.0 m
E-Line lumen package (L 1.5 m) .....	4,200 lm (PW19)
E-Line lumen package (L 1.5 m) .....	5,500 lm (LAN)
Room dimensions* .....	60-70 m <sup>2</sup>
UGR .....	≤ 19

### Normative requirement

$\bar{E}_m \geq 300-500 \text{ lux} - U_o \geq 0.60$  – General illumination (PW19)  
 $\bar{E}_m \geq 500 \text{ lux} - U_o \geq 0.70$  – Panel illumination (LAN)

\*AMEV Lighting 2016



PW19



LAN



PMW19



EVERYTHING REMAINS. **EXC**



**EPT WITH HIGHER QUALITY.**

# E-LINE NEXT LED

MORE THAN JUST A PRODUCT



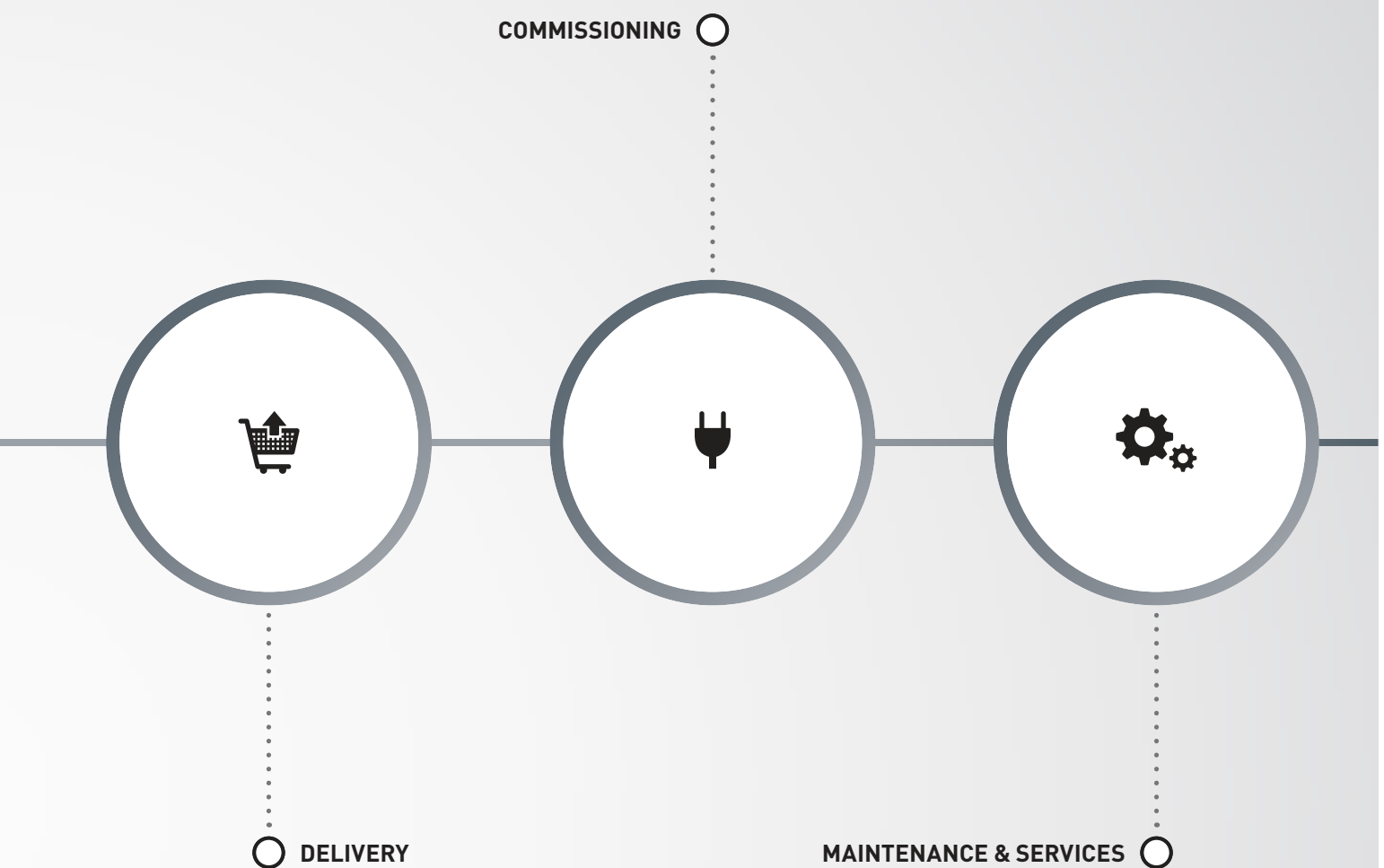

TRILUX benefits from decades of experience in the field of continuous line lighting. Qualitative materials, in-house developed optics and photometric expertise ensure products of the highest quality. Customer needs are also the focus of every product development.

However, it is not only the product that is constantly developed further – with individual services, TRILUX ensures smooth flow in projects and is therefore the perfect partner in the continuous line lighting sector. From initial project planning and advice about possible financing models to installation, commissioning and regular maintenance of the installation – we support you in every phase of your project.

## E-LINE NEXT LED

CONFIGURED QUICKLY  
AND SIMPLY





With the E-Line Configurator, lighting designers and architects have the enormous range of variants under their control. The system guides the user through the configuration process and suggests suitable optics for the specific application. Especially convenient: data can simply be saved, transferred directly into the ERP system and used again as a starting point for further projects.

3	Trunking	
3	Colours	
3	Protection ratings	
2	Mounting options	
3	Gear tray lengths	
3	Lifespans	
20	Light distributions	
37	Luminous flux packages	
4	Light colours	
2	CRI indices	
2	Circuit types	
>11	Supplementary modules	

## E-LINE NEXT LED

OPTIMISED  
PACKAGING SIZES



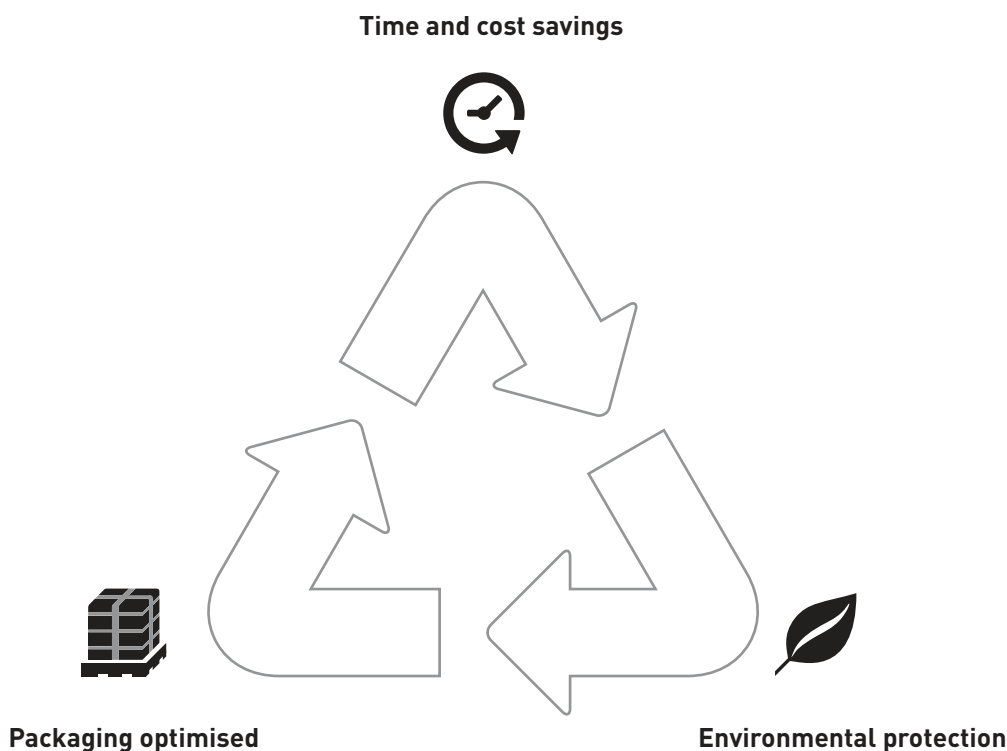

E-Line Next LED focuses on sustainable solutions. From packaging to best energy efficiency to a sustainable, modular product concept.

- Optimised packaging size – less effort, less waste, lower costs
- Efficient luminaires save energy
- Integrate light management and save up to 80% energy
- Component of sustainable building certification such as BREEAM or DGNB integrated with E-Line Next LED

Highest energy efficiency for maximum sustainability: we help companies to improve their carbon footprint through particularly energy-efficient products. An LED solution reduces energy consumption by up to 55% compared to conventional lighting, and when combined with a light management system this is even up to 80%. TRILUX solutions regularly set new standards in energy efficiency and are an important component in sustainable building certification, such as BREEAM or DGNB. Sustainability and climate protection are not only limited to efficient products. TRILUX is also committed to corporate responsibility, creating transparency in the supply chain and researching pioneering concepts for resource conservation and material efficiency. For detailed information, see the TRILUX Sustainability Report at [www.trilux.com/nachhaltigkeit](http://www.trilux.com/nachhaltigkeit).



E-Line Next LED was awarded by the German Sustainability Award in the Design category.

E-LINE NEXT LED

REPRO-LIGHT



## Sustainable lighting with Repro-Light

The Repro Light Report is a sustainability assessment to be able to evaluate the relevance of interchangeability, reuse and recycling of the assemblies of an LED luminaire and the influence of individual phases of the life cycle in terms of climate protection and the conservation of resources.

The assessment is based on various essential sustainability factors: global warming potential, primary energy demand, abiotic depletion potential, elements/fossils, acidification potential and eutrophication potential.

The repro-light results also offer an interesting starting point for optimising luminaires with regard to ecological criteria. E-Line Next LED has achieved high success here. The current model of the luminaire is more than 61% better for the environment than its previous version, measured by Abiotic Depletion Potential\* (ADP). This was achieved by largely avoiding particularly precious materials, especially in the area of the LED module:

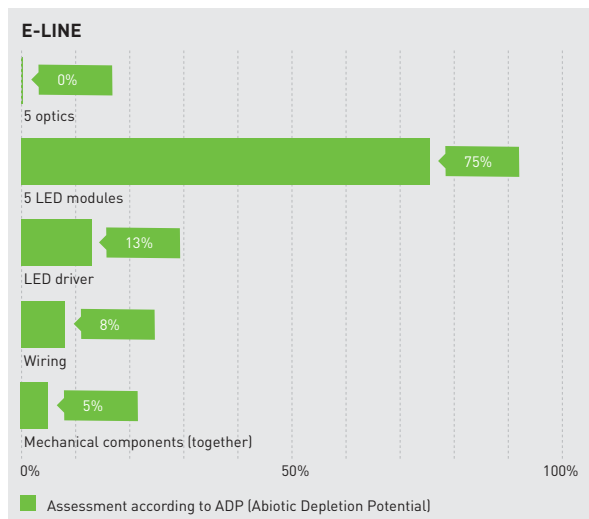

conditions for reuse are already in place.



See the TRILUX sustainability report online:  
[www.trilux.com/sustainability](http://www.trilux.com/sustainability).

## LICHTMANAGEMENT INDOOR

SIMPLE PLANNING  
RAPID INSTALLATION  
INTUITIVELY OPERATED





# LiveLink



### Simple planning

The LiveLink Install app on a tablet simplifies planning by means of pre-set room configurations (Use Cases). TRILUX configures project-specific settings on request and provides them via TRILUX ONE.



### HCL integration

Light colour impacts numerous reactions in the human body, for instance concentration and performance capability, well-being and biorhythm. Human Centric Lighting solutions use these effects by adapting the light colour to user needs in a targeted way. With LiveLink, even complicated HCL applications can be implemented quickly and simply. To this end, the Use Cases feature stored progression curves in the various applications which meet the respective requirements ideally.



### Rapid installation

LiveLink system and system components are only connected to one another using DALI. Programming and commissioning are done in a time-saving, simple manner via a graphic user interface on mobile iOS and Android devices. Simplified installation in refurbishment cases by radio networking of luminaires: retro-active installation of DALI control lines is not required, signals are transmitted to the luminaires wirelessly.



### Intuitive operation

In practice, there are many functions which LiveLink executes automatically. Those include controlling the lighting level with daylight-dependent control and presence detection. If further light scenes are required, the luminaires can be controlled via smartphone or traditionally via push-button. There's hardly a simpler way.

## When intelligence comes to light.

LiveLink is the key to intelligent lighting control, bringing the quality of light and efficiency to a new level. Whether refurbishment or new building construction – the system offers the right solution for almost every application:

	LiveLink Workspace	LiveLink Basic	LiveLink SwarmSens	LiveLink WiFi	LiveLink Wireless	LiveLink Connect	LiveLink Premium	LiveLink Retail
	Your Personal Office Light	The entry-level solution	The pioneer	The smart all-rounder	The refurbishment professional	The networkable	The individual all-rounder	The smart one for retail spaces
Presence detection	✓	✓	✓	✓	✓	✓	✓	✓
Constant light control	✓	✓	-	✓	✓	✓	✓	✓
Threshold function	-	-	✓	-	-	-	-	-
Light scenes	✓	-	-	✓	✓	✓	✓	✓
Sequences	-	-	-	✓	-	✓	✓	✓
General light	-	✓	✓	✓	✓	✓	✓	✓
Human Centric Lighting	✓	-	-	✓	-	✓	✓	✓
Master-slave networking	-	-	✓	-	-	✓	-	✓
Plug and play function <sup>1</sup>	✓	✓	✓	-	-	-	-	-
Cloud connection	-	-	-	✓ <sup>2</sup>	✓ <sup>3</sup>	✓ <sup>2</sup>	✓ <sup>2</sup>	✓ <sup>2+3</sup>
Monitoring (MOR luminaires)	-	-	-	✓	-	✓	✓	-
Emergency light monitoring (DALI single battery)	-	-	-	✓	-	✓	✓	-
Radio networking (mesh)	✓	-	✓	-	✓	-	✓	✓
Integration of building plans	-	-	-	-	-	-	✓	✓
Connection to building control system	-	-	-	-	-	-	✓	✓
Control via push-button	✓	✓	-	✓	✓	✓	✓	✓
Control via app	✓	✓	-	✓	✓	✓	✓	✓
Remote access	-	-	-	✓	-	✓	✓	✓

<sup>1</sup> ready for operation after electrical connection (no further commissioning required)

<sup>2</sup> Energy and Light Monitoring / Remote Control / System Backup

<sup>3</sup> Remote Control

# HUMAN CENTRIC LIGHTING

EXPERIENCING  
NATURAL LIGHT

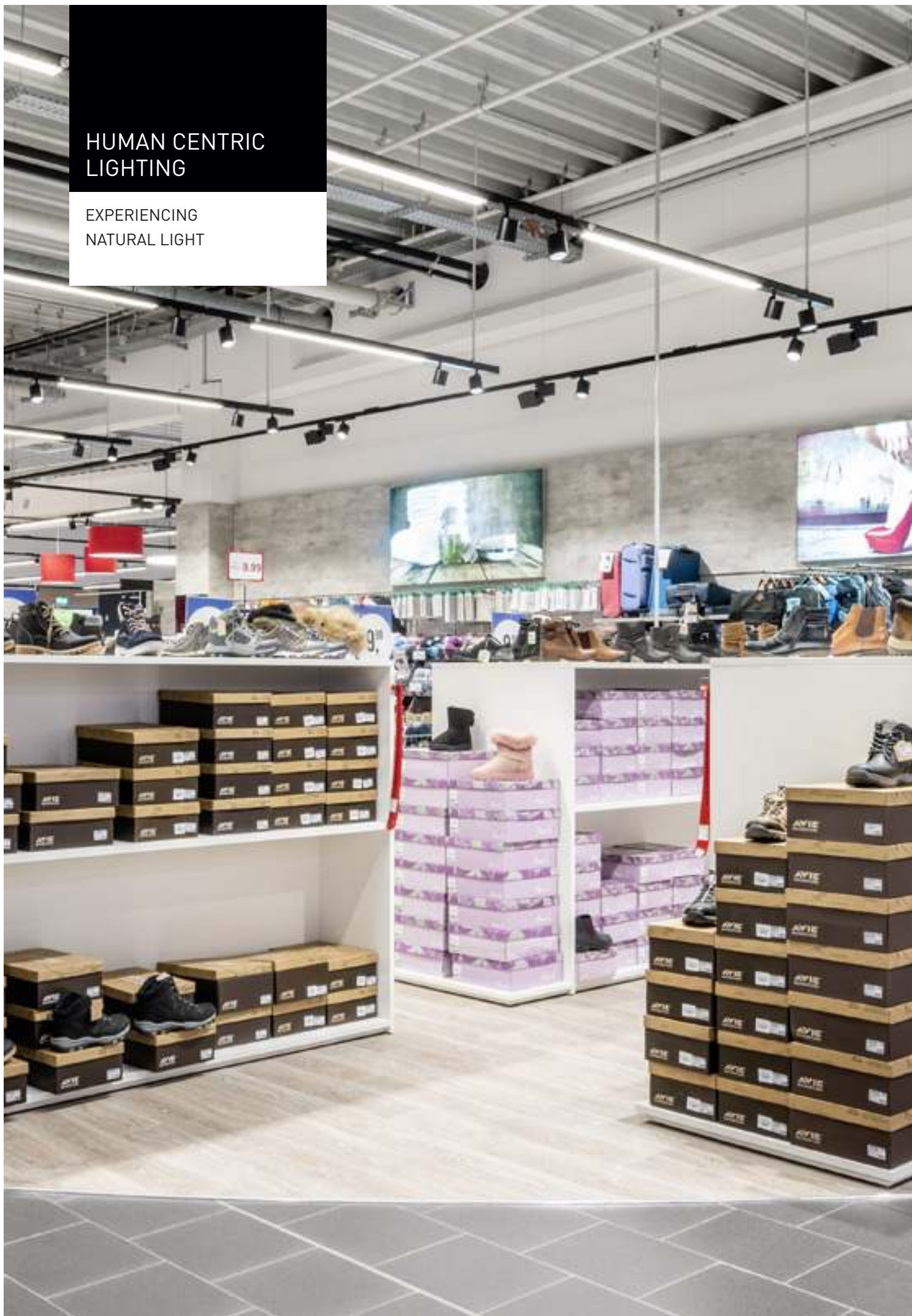



Light has many facets that need to be considered when designing future-capable lighting solutions. At TRILUX we offer an important added value: we place people with their specific needs at the centre. For TRILUX customers this consistent targeting of the solution to the user is the fundamental basis of good lighting.

Light must provide more than just optimum visual conditions complying with appropriate standards. Light colour and lighting intensity for example influence mood, well-being and the capability to perform. The biological rhythm of people can also be improved by adapting the light colour and intensity of lighting to the natural course of daylight. This even occurs automatically with intelligent light control – the right light at the right time.

A Human Centric Lighting solution is always based on a professionally planned lighting concept where all components are precisely matched to the requirements of the client and the specific application. This enables high performance, customised systems that optimally support people in their range of tasks. According to its brand promise of Simplify Your Light, TRILUX ensures that using such solutions is as simple as possible.

A TRILUX HCL lighting solution always consists of three components: the luminaire, the control and lighting consulting.

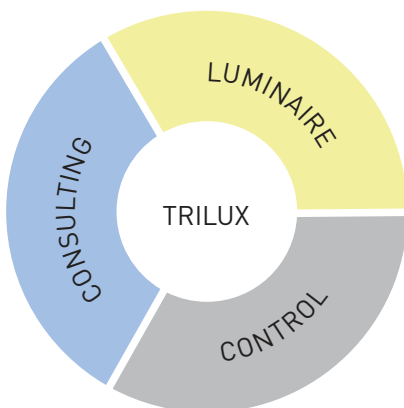

Only this way do customers receive optimum advice and light ideally adapted to their needs. TRILUX offers a wide portfolio of cutting-edge technologies and products to achieve this, and brings together single components to create customised, complete solutions.

LIGHTING SOLUTIONS  
& SERVICES

HOLISTIC EXPERTISE

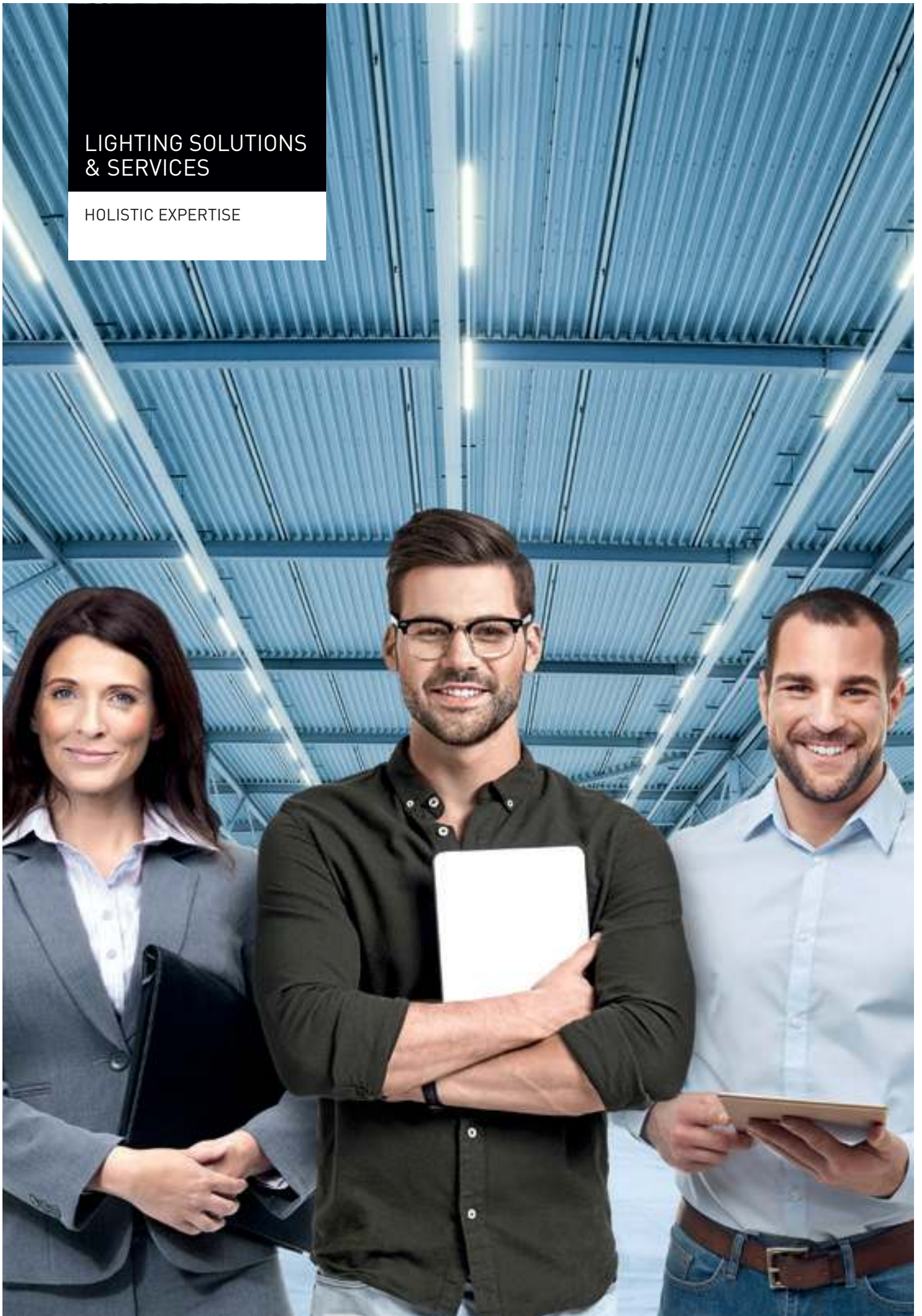



### Achieving perfect light was never simpler

The lighting market has changed enormously due to the LED transformation, increasing digitalisation and social mega-trends such as connectivity and big data. On the one hand this provides diverse opportunities and on the other, lighting solutions are becoming increasingly complex and their selection, configuration and operation more complicated.

**TRILUX makes this complexity manageable thanks to intelligent solutions that set new standards in terms of energy efficiency and quality of light, and also by offering a wide range of customer-oriented services.**



#### ORIENTATION AND SAFETY

The increasing complexity of lighting solutions is changing the knowledge used over many years, and also places new demands on all participants with regard to the efficiency, quality, performance and service life of lighting solutions. Furthermore, new challenges placed on the building flow into the planning process – and as a result future construction projects will not only become more intelligent but will also be designed in a more sustainable way.

**We clarify together with you which technologies and products are most suited to your needs.**



#### SUPPORT

Large building and refurbishment projects demand farsightedness and a corresponding overview, as well as appropriate resources with the planning, implementation and operation of a new building. Upon request we take on all tasks concerning the lighting, ranging from technological consulting and custom financing concepts to installation work and extensive digital services.

**This gives you the freedom you need to concentrate on your own business.**



#### SAVINGS

An efficiently planned lighting solution not only considers costs, potential savings and financing options. TRILUX offers various financing models to customers who wish to realise their systems in a balance-neutral way to protect their own capital and maintain their financial flexibility.

**We draw up individual concepts in agreement with you to fulfil your precise requirements.**



#### ENVIRONMENTAL AWARENESS AND SUSTAINABILITY

The lighting solution is a central part of sustainable building management and has a major influence on gaining certifications such as Green Building or BREEAM. Greenhouse gas emissions can be sustainably reduced via environmentally protective lighting installations based on state-of-the-art LED technology and intelligent control solutions. Digital services from TRILUX also enable the monitoring of operationally relevant data such as energy consumption during operation.

**We are also available to you after commissioning.**



**Real-time monitoring**

With TRILUX Monitoring Services, the operating parameters of a lighting installation can be effortlessly monitored and analysed in real time via the LiveLink Cloud. This transparency makes it possible, for example, to specifically optimise the energy consumption of E-Line Next LED and to adapt pending maintenance work to actual requirements (predictive maintenance). All DALI drivers guarantee future security thanks to the MOR (monitoring ready) function.

Function	ENERGY MONITORING	LIGHT MONITORING
current energy consumption per luminaire	✓	✓
12-month energy consumption per luminaire	-	✓
Operating status (on/off)	✓	✓
Operating time (h)	✓	✓
Presence of status/error messages	✓	✓
Dimming level	-	✓
Predictive maintenance + remaining operating time (h)	-	✓
Raw data interface (API)	-	✓
Temperature of control gear unit	-	✓
Report/analysis data (PDF+graphic)	-	✓
Remote access (scenes)	-	✓
Sensor data analysis	-	✓
Remote maintenance	-	✓
Visualisation of floor plan*	-	✓
Back-up of system configuration*	-	✓

\* LiveLink Premium



### **Tailor-made financing**

You can benefit from the advantages of a modern, efficient and high-performance lighting system with a form of financing that perfectly fits your individual needs and possibilities – whether rental, hire purchase or leasing. Together with you we draw up the ideal financing solution for your project. TRILUX Light as a Service offers ideal conditions for implementing your E-Line Next LED project, even without affecting the balance sheet or capitalising your equity.

More info: [www.light-as-a-service.de](http://www.light-as-a-service.de)

### **Technical services and project management**

On request, TRILUX can assume complete project management for your new E-Line Next LED system. Starting with lighting design and disassembly of the obsolete system to commissioning of the new lighting solution. Companies are unburdened, allowing them to concentrate on their core areas of expertise.

QUALITY

TAILOR-MADE LIGHTING  
CONCEPTS



German engineering, customised solutions and innovative design – this all points to 'Made by TRILUX'. The German market leader for technical lighting traditionally focuses on value, workmanship and products of the highest quality that can be flexibly adapted to the individual framework conditions and needs of the users. TRILUX not only offers standard solutions but also develops customised lighting concepts in close cooperation with the client. These fulfil all normative requirements and are winning solutions, both functionally and in terms of ambience. High-quality materials, optics developed in-house, pioneering lighting technology and a research and development division that continuously and consistently searches for optimisation potential at all levels – "Made by TRILUX" is a guarantee for premium quality in all areas.



EVERYTHING REMAIN



**S. EXCEPT SIMPLER.**

# TRILUX ONE

ONE LOGIN.  
MANY ADVANTAGES.

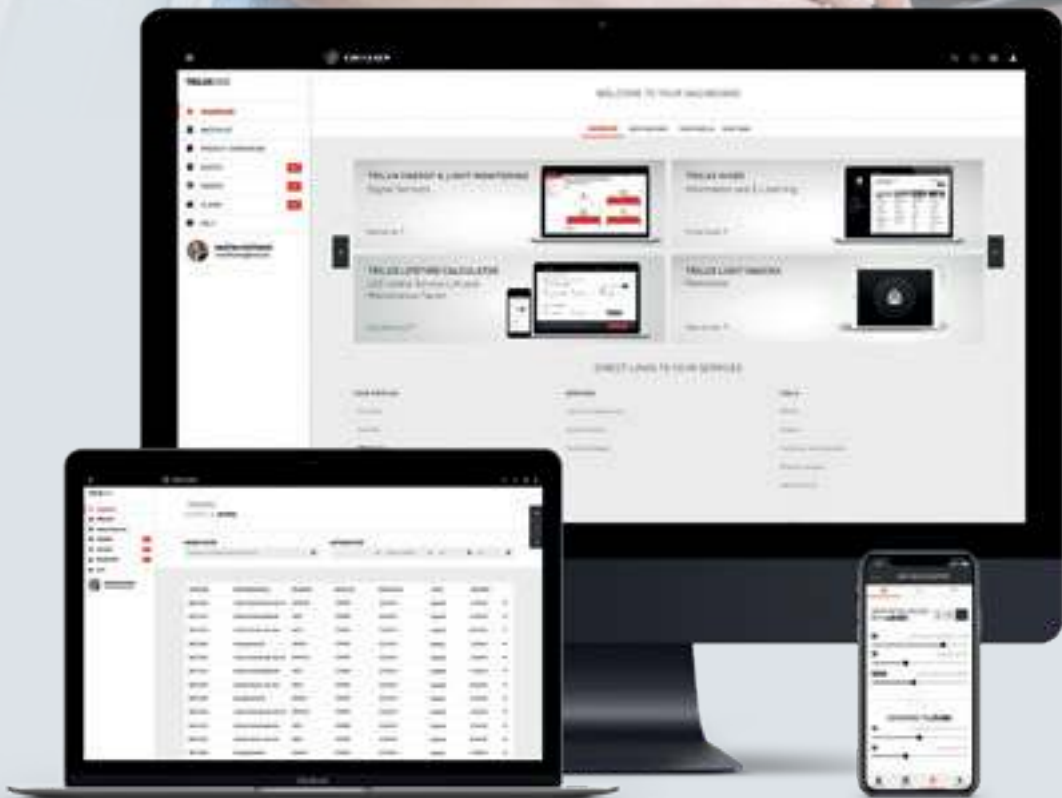

In addition to the personal business relationship, TRILUX relies on digital possibilities to make processes even more efficient and easier for you in the future.

We have expanded the TRILUX Portal to now offer you further practical functions and services for your daily business – all under the name of TRILUX ONE.



#### **DIGITAL SERVICES**

##### **Light management and connectivity**

- Register now: Always keep an eye on the energy consumption of your lighting installation in the TRILUX Cloud.
- Take advantage of the Energy Monitoring and Light Monitoring connectivity services for monitoring and maintenance of the networked lighting.



#### **USEFUL AIDS**

##### **From watchlists to the Efficiency Calculator**

- Save products on your watchlist or directly in your individual project
- Use the product comparison function for simple selection of the most suitable product.
- Calculate the specific maintenance factor with the Lifetime Calculator, or calculate investment- and operating costs as well as savings potential with the Energy Efficiency Calculator.
- With the TRILUX lighting concepts, you create room solutions in next to no time for ad-hoc comparisons of lighting effects.



#### **SIMPLE PROJECT WORK**

##### **Manage your projects quickly and simply**

- Create a project quickly and simply and equip it with your preferred TRILUX luminaires. The Portal does the rest – determining gross prices and compiling all necessary documents for you.
- Invite other people to process and edit the various project phases with you.



#### **SMART CONFIGURATORS**

##### **Simple creation with just a few clicks**

- Even complex continuous line systems are created with simplicity with just a few clicks.
- Our configurators enable targeted product selection according to your specific needs.

## LIGHT KNOWLEDGE

CERTIFICATE COURSES  
THEME DAYS, SEMINARS,  
IN PRESENCE AND ONLINE



## Welcome to the TRILUX Akademie!

The TRILUX Akademie is the qualification partner for everyone professionally concerned with light. Light becomes intelligent, it can have activating or relaxing effects, it can be networked, combined with sensors and monitored and controlled via cloud. The latest specialist knowledge is vital to ideally exploit the possibilities created by new products and applications. The TRILUX Akademie communicates expert knowledge in the form of various training formats for any training need. The wide-ranging programme of theme days, seminars and webinars enables experienced lighting professionals to stay up-to-date and to expand their expertise in a targeted way, for instance regarding digitalisation or Human Centric Lighting. For starters in the profession, we offer certificate courses that establish a solid foundation for subsequent activities. Manufacturer-neutral certificates serve as proof of expertise and skills obtained.

## Our training offers are structured into 9 thematic domains



### 1. Current developments

Technology change in lighting is rapid. We address important discoveries, technologies, trends and other topics and communicate them under the "Current developments" umbrella.



### 5. Human Centric Lighting

Human Centric Lighting currently is one of the most significant topics in the lighting industry. We communicate the necessary knowledge for this in compact webinars and seminars.



### 2. Basic knowledge lighting technology – electrical engineering

Those intending to start out in the electrical engineering field can obtain solid basic knowledge via our certificate courses. In addition, there are compact webinars and seminars for special topics.



### 6. Connectivity

Lighting can already be integrated into networks and controlled via computers or mobile end devices today. We show you how it works.



### 3. Lighting design – Indoor

Our basic course provides the tools of the trade for designers. When it comes to required knowledge regarding computer-based indoor design, we recommend more specialised beginners' and advanced courses with DIALux and Relux.



### 7. Efficiency and economy

These factors are absolutely essential for modern lighting installations. We teach lighting professionals what is required in this regard and how it can be realised at a current level of technology.



### 4. Lighting design – Outdoor

Our basic course provides the tools of the trade for designers. When it comes to required knowledge regarding computer-based outdoor design, we recommend more specialised beginners' and advanced courses with DIALux and Relux.



### 8. Retail

In retail, the right light must do more than create good visual conditions. The art is in making merchandise appear lively, appetising and desirable. Our special seminars communicate how this can be achieved.



### 9. Environment and sustainability

The order of the day is to make technology change sustainable, and therefore to use efficient and smart technologies. In our seminars and webinars, we demonstrate and discuss meaningful contributions to sustainable environmental, climate and health protection.

**TRILUX GmbH & Co. KG**

Heidestraße · D-59759 Arnsberg  
Postfach 19 60 · D-59753 Arnsberg  
Tel. +49 29 32.3 01-0  
Fax +49 29 32.3 01-3 75  
sales@trilux.com  
www.trilux.com

**TRILUX Vertrieb GmbH  
Key Account Management**

Heidestraße 4 · D-59759 Arnsberg  
Tel. +49 29 32.3 01-44 96  
Fax +49 29 32.3 01-49 70  
kam@trilux.com  
www.trilux.com

**TRILUX LIGHTING LIMITED**

TRILUX HOUSE, Winsford Way  
Boreham Interchange  
Chelmsford, Essex  
CM2 5PD  
Tel. +44 12 45.46 34 63  
Fax +44 12 45.46 26 46  
info.co.uk@trilux.com  
www.trilux.com

**TRILUX Česká republika s.r.o.**

Walterovo náměstí 329/3  
CZ-158 00, Praha 5  
Tel.: +420 272 706 351  
Fax: +420 235 524 588  
info.cz@trilux.com  
www.trilux.com

**TRILUX Hungária Kft.**

BudaPlaza Irodaház  
Budafoki u. 111.  
H-1117 Budapest  
Tel. +36 1.4 81 04 69  
Fax +36 1.4 81 04 70  
info.hu@trilux.com  
www.trilux.com

**TRILUX Lighting (India) Pvt. Ltd.**

719-720, International Trade Tower  
Nehru Place, New Delhi-110019  
India  
Tel.: +91 (11) 4103 4322  
salesindia@trilux.com  
www.trilux.com

**TRILUX Polska Sp. z o. o.**

Ul. Posag 7 Panien 1  
PL-02-495 Warszawa  
Tel. +48 22.6 71 62 88 (89)  
Fax +48 22.6 71 63 00  
trilux@trilux.com.pl  
www.trilux.com

**TRILUX Slovakia s.r.o.**

Galvaniho 7  
SK-82104 Bratislava  
Tel. +421 2 43 42 26 11  
Fax +421 2 43 42 26 27  
info.sk@trilux.com  
www.trilux.com

**TRILUX Middle East**

Representative Office  
TRILUX GmbH & Co KG  
Building: 5EA, Office 808 & 810  
P.O. Box: 371040  
Dubai Airport Free Zone (DAFZA)  
Dubai, United Arab Emirates  
Tel.: +971 4 6091991  
Fax: +971 4 6091826  
middleeast@trilux.com  
www.trilux.com/en

All technical data including dimensional and weight specifications have been checked carefully. Errors excepted. Possible colour deviations are due to printing processes. We reserve the right to modify in the interest of progress. Luminaires are partly shown with accessories that must be ordered separately. Images of installations may show custom manufactured luminaires. Printed on PEFC-certified paper in an environmentally friendly way.



