

# RAIL

INVISIBLE CONNECTION. VISIBLE IMPACT.

**PLANNING AID**  
TRACK SYSTEM RAIL



## RAIL BASICS

# PLANNING GUIDE 3-CIRCUIT TRACKS STUCCHI

This compact planning guide is designed to help you get a quick and easy overview of the various options in our track portfolio, recognize the special features of the individual variants and compile a list of the necessary materials for your individual 3-circuit track project.

Our extensive 3-circuit track range enables the implementation of extremely flexible infrastructures for the power supply of long-life lighting systems – in compliance with legal regulations and standards.

The technical design of the 3-circuit track makes it possible to set the lighting system to three separately switchable phases: e.g. basic, accent and decorative lighting or similar.

In addition to the individual copper conductors for the phases and the neutral conductor, the DALI version has two additional conductors integrated into the tracks to transmit the control signal.

The electrical connection of the supply line is made using the feeders (9001, 9002) or via all L, T, X and I connectors. It is not possible to feed in through an articulated or flexible connector.

**When planning, make sure that the polarity ridge (red, wide line - see schematic diagrams, from page 16) is connected throughout!**

3-circuit tracks can be extended almost indefinitely, taking into account the load distribution to the individual phases (max. 16A) and the on-site fuse protection of the load circuits. (Attention: please observe the inrush currents of the luminaires!) The individual track units are electrically connected, for example, using the 9003 longitudinal coupling (surface-mounted, recessed) or 9000-KIT32 (flush-mounted) or the familiar corner, T or cross connectors. If the track is only to be connected optically, but not electrically, the longitudinal coupling 9003/----M (surface-mounted, recessed) or 9000-KIT34 (flush-mounted) is used.

The recessed, flush-mounted and surface-mounted tracks can be cut to any desired length on site using a metal saw. In this case, the offer should include a cutting tool. This allows the phases to be cut to length at the shortened end so that a feeder, connector or an end cap can be fitted. The suspended tracks with indirect section are available in two preconfigured lengths and cannot be shortened on site.

The tracks are approved for use within arm's reach. For low mounting heights, vertical wall or floor mounting, the use of plastic covers is recommended as protection against the ingress of foreign objects, fingers or similar. These are always one meter long and can be cut to size on site after the luminaires have been installed so that they fit into the gaps.

For suspended mounting of the surface-mounted track, depending on the alignment of the spotlights, suspension via a pendant rod (9000-KIT27) is recommended to stabilize the track. For suspended mounting of the surface-mounted track, additional use of a 9000-KIT35 joint connector (9000-KIT36 in the case of the high track with indirect section) is also recommended for mechanical connection of the tracks.

Recessed tracks differ from surface-mounted tracks only by their so-called lateral „wings“. They are attached to an on-site substructure within the ceiling.

Flush-mounted tracks behave in exactly the same way as recessed tracks, but here the lateral frame is plastered in. They are attached to the bare ceiling using the 9000-KIT37 accessory.

The high track is an H-profile with a preconfigured indirect section. The lower section behaves like a surface-mounted track.

Further information can be found in the TRILUX product data sheets and the manufacturer's installation instructions. The installation instructions are enclosed with every delivery.

# RAIL SURFACE-MOUNTED/SUSPENDED TRACK BLACK

AutoCAD symbols	Designation	Quantity		Description	Weight	TOC
	9000-4-ST, 4 m, freely shortenable	1		3PH ETDD Surface-mounted/suspended track 4 m	3.8 kg	8903600
	9000-3-ST, 3 m, freely shortenable	1		3PH ETDD Surface-mounted/suspended track 3 m	2.8 kg	8903500
	9000-2-ST, 2 m, freely shortenable	1		3PH ETDD Surface-mounted/suspended track 2 m	1.9 kg	8903400
	9000-1-ST, 1 m, freely shortenable	1		3PH ETDD Surface-mounted/suspended track 1 m	1.0 kg	8903300
	S-9000/GP, 1 m, freely shortenable	1		3PH ETDD Blanking cover 1 m	0.3 kg	8881200
	S-9000/T, piece	1		3PH ETDD Cutting tool	0.3 kg	8881400
	9001	1		3PH ETDD Feeder right	0.1 kg	8881600
	9002	1		3PH ETDD Feeder left	0.1 kg	8881800
	9003	1		3PH ETDD Joint connector conductive	0.1 kg	8882200
	9003/...M	1		3PH ETDD Joint connector non-conductive	0.1 kg	8882400
	9000-KIT35	1		3PH ETDD Joint connector conductive with mechanical connection	0.2 kg	8913100
	9000-KIT28-1.5	1		3PH ETDD Joint connector conductive with cable suspension 1.5 m	0.2 kg	8899800
	9000-KIT28-3.0	1		3PH ETDD Joint connector conductive with cable suspension 3.0 m	0.2 kg	8900000
	9004	1		3PH ETDD End cap	0.1 kg	8880400
	9010	1		3PH ETDD Line connector	0.2 kg	8882000
	9011	1		3PH ETDD L-connector left	0.2 kg	8882600
	9012	1		3PH ETDD L-connector right	0.2 kg	8882800
	9013	1		3PH ETDD T-connector left	0.3 kg	8883000
	9014	1		3PH ETDD T-connector right	0.3 kg	8883400
	9015	1		3PH ETDD T-connector left	0.3 kg	8883200
	9016	1		3PH ETDD T-connector right	0.3 kg	8883600
	9017	1		3PH ETDD X-connector	0.4 kg	8883800
	9018	1		3PH ETDD Flex connector	0.2 kg	8884000
	9000-KIT8-1.5	1		3PH ETDD Height-adjustable suspension set 1.5 m	0.1 kg	8888600
	9000-KIT8-3.0	1		3PH ETDD Height-adjustable suspension set 3.0 m	0.1 kg	8888800
	9000-KIT27	1		3PH ETDD Pendulum rod 1.2 m	0.6 kg	8898800
	S-9000/119-TB	1		3PH ETDD Caddy clip black/black	0.1 kg	8900700
	S-9000/115	1		3PH ETDD Ceiling clip	0.1 kg	8888600
	S-9000/131	1		3PH ETDD Ceiling clip	0.1 kg	9242900

Maximum distance between fixing points = 1.5 m | Maximum total weight between two fixing points = 20 kg

# RAIL SURFACE-MOUNTED/SUSPENDED TRACK WHITE

AutoCAD symbols	Designation	Quantity		Description	Weight	TOC
	9000-4-ST, 4 m, freely shortenable	1		3PH ETDD Surface-mounted/suspended track 4 m	3.8 kg	8901200
	9000-3-ST, 3 m, freely shortenable	1		3PH ETDD Surface-mounted/suspended track 3 m	2.8 kg	8901100
	9000-2-ST, 2 m, freely shortenable	1		3PH ETDD Surface-mounted/suspended track 2 m	1.9 kg	8901000
	9000-1-ST, 1 m, freely shortenable	1		3PH ETDD Surface-mounted/suspended track 1 m	1.0 kg	8900900
	S-9000/GP, 1 m, freely shortenable	1		3PH ETDD Blanking cover 1 m	0.3 kg	8881300
	S-9000/T, piece	1		3PH ETDD Cutting tool	0.3 kg	8881400
	9001	1		3PH ETDD Feeder right	0.1 kg	8881700
	9002	1		3PH ETDD Feeder left	0.1 kg	8881900
	9003	1		3PH ETDD Joint connector conductive	0.1 kg	8882300
	9003/...M	1		3PH ETDD Joint connector non-conductive	0.1 kg	8882500
	9000-KIT35	1		3PH ETDD Joint connector conductive with mechanical connection	0.2 kg	8913200
	9000-KIT28-1.5	1		3PH ETDD Joint connector conductive with cable suspension 1.5 m	0.2 kg	8899900
	9000-KIT28-3.0	1		3PH ETDD Joint connector conductive with cable suspension 3.0 m	0.2 kg	8900100
	9004	1		3PH ETDD End cap	0.1 kg	8880700
	9010	1		3PH ETDD Line connector	0.2 kg	8882100
	9011	1		3PH ETDD L-connector left	0.2 kg	8882700
	9012	1		3PH ETDD L-connector right	0.2 kg	8882900
	9013	1		3PH ETDD T-connector left	0.3 kg	8883100
	9014	1		3PH ETDD T-connector right	0.3 kg	8883500
	9015	1		3PH ETDD T-connector left	0.3 kg	8883300
	9016	1		3PH ETDD T-connector right	0.3 kg	8883700
	9017	1		3PH ETDD X-connector	0.4 kg	8883900
	9018	1		3PH ETDD Flex connector	0.2 kg	8884000
	9000-KIT8-1.5	1		3PH ETDD Height-adjustable suspension set 1.5 m	0.1 kg	8888600
	9000-KIT8-3.0	1		3PH ETDD Height-adjustable suspension set 3.0 m	0.1 kg	8888800
	9000-KIT27	1		3PH ETDD Pendulum rod 1.2 m	0.6 kg	8898900
	S-9000/119-TB	1		3PH ETDD Caddy clip white/white	0.1 kg	8900700
	S-9000/115	1		3PH ETDD Ceiling clip	0.1 kg	8888700
	S-9000/131	1		3PH ETDD Ceiling clip	0.1 kg	9243000

Maximum distance between fixing points = 1.5 m | Maximum total weight between two fixing points = 20 kg

# RAIL SURFACE-MOUNTED/SUSPENDED TRACK – PLANNING EXAMPLE

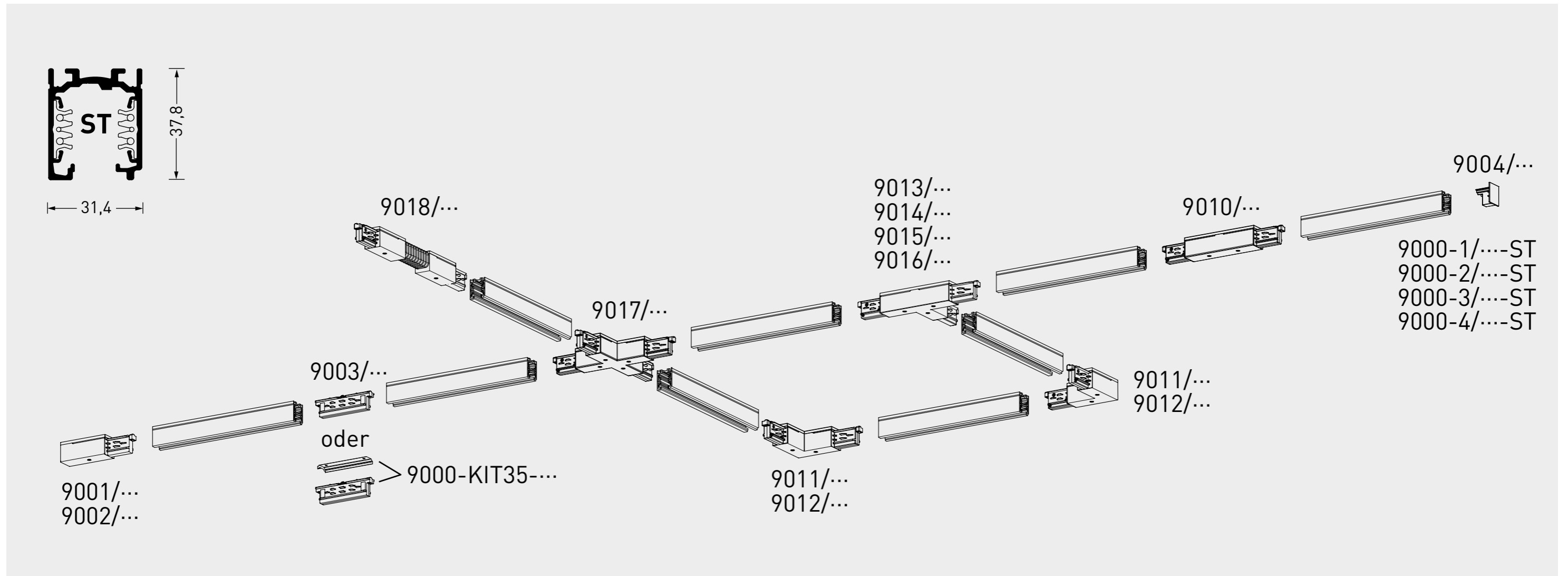

# RAIL RECESSED TRACK BLACK

AutoCAD symbols	Designation	Quantity		Description	Weight	TOC
	9000-4-R, 4 m, freely shortenable	1		3PH ETDD Recessed track 4 m	3.8 kg	8904000
	9000-3-R, 3 m, freely shortenable	1		3PH ETDD Recessed track 3 m	2.8 kg	8903900
	9000-2-R, 2 m, freely shortenable	1		3PH ETDD Recessed track 2 m	2.0 kg	8903800
	9000-1-R, 1 m, freely shortenable	1		3PH ETDD Recessed track 1 m	1.0 kg	8903700
	S-9000/GP, 1 m, freely shortenable	1		3PH ETDD Blanking cover 1 m	0.3 kg	8881200
	S-9000-T, piece	1		3PH ETDD Cutting tool	0.3 kg	8881400
	9001	1		3PH ETDD Feeder right	0.1 kg	8881600
	9002	1		3PH ETDD Feeder left	0.1 kg	8881800
	9001-R/6	1		3PH ETDD Recess cover for feeders	0.1 kg	8886400
	9003	1		3PH ETDD Joint connector conductive	0,0 kg	8882200
	9003/...M	1		3PH ETDD Joint connector non-conductive	0.1 kg	8882400
	9000 KIT35	1		3PH ETDD Joint connector conductive with mechanical connection	0.2 kg	8913100
	9004-R	1		3PH ETDD End cap	0.1 kg	8880600
	9010	1		3PH ETDD Line connector	0.2 kg	8882000
	9010-R/6	1		3PH ETDD Line connector cover	0.1 kg	8886600
	9011	1		3PH ETDD L-connector left	0.2 kg	8882600
	9012	1		3PH ETDD L-connector right	0.2 kg	8882800
	9011-R/6	1		3PH ETDD L-connector cover	0.2 kg	8886800
	9013	1		3PH ETDD T-connector left	0.3 kg	8883000
	9014	1		3PH ETDD T-connector right	0.3 kg	8883400
	9015	1		3PH ETDD T-connector left	0.3 kg	8883200
	9016	1		3PH ETDD T-connector right	0.3 kg	8883600
	9013-R/6	1		3PH ETDD T-connector cover	0.1 kg	8887000
	9017	1		3PH ETDD X-connector	0.4 kg	8883800
	9017-R/6	1		3PH ETDD X-connector cover	0.1 kg	8887200

Maximum distance between fixing points = 1.5 m | Maximum total weight between two fixing points = 20 kg

# RAIL RECESSED TRACK WHITE

AutoCAD symbols	Designation	Quantity		Description	Weight	TOC
	9000-4-R, 4 m, freely shortenable	1		3PH ETDD Recessed track 4 m	3.8 kg	8901600
	9000-3-R, 3 m, freely shortenable	1		3PH ETDD Recessed track 3 m	2.8 kg	8901500
	9000-2-R, 2 m, freely shortenable	1		3PH ETDD Recessed track 2 m	2.0 kg	8901400
	9000-1-R, 1 m, freely shortenable	1		3PH ETDD Recessed track 1 m	1.0 kg	8901300
	S-9000/GP, 1 m, freely shortenable	1		3PH ETDD Blanking cover 1 m	0.3 kg	8881300
	S-9000-T, piece	1		3PH ETDD Cutting tool	0.3 kg	8881400
	9001	1		3PH ETDD Feeder right	0.1 kg	8881700
	9002	1		3PH ETDD Feeder left	0.1 kg	8881900
	9001-R/6	1		3PH ETDD Recess cover for feeders	0.1 kg	8886500
	9003	1		3PH ETDD Joint connector conductive	0,0 kg	8882300
	9003/...M	1		3PH ETDD Joint connector non-conductive	0.1 kg	8882500
	9000 KIT35	1		3PH ETDD Joint connector conductive with mechanical connection	0.2 kg	8913200
	9004-R	1		3PH ETDD End cap	0.1 kg	8880700
	9010	1		3PH ETDD Line connector	0.2 kg	8882100
	9010-R/6	1		3PH ETDD Line connector cover	0.1 kg	8886700
	9011	1		3PH ETDD L-connector left	0.2 kg	8882700
	9012	1		3PH ETDD L-connector right	0.2 kg	8882900
	9011-R/6	1		3PH ETDD L-connector cover	0.2 kg	8886900
	9013	1		3PH ETDD T-connector left	0.3 kg	8883100
	9014	1		3PH ETDD T-connector right	0.3 kg	8883500
	9015	1		3PH ETDD T-connector left	0.3 kg	8883300
	9016	1		3PH ETDD T-connector right	0.3 kg	8883700
	9013-R/6	1		3PH ETDD T-connector cover	0.1 kg	8887100
	9017	1		3PH ETDD X-connector	0.4 kg	8883900
	9017-R/6	1		3PH ETDD X-connector cover	0.1 kg	8887300

**Maximum distance between fixing points = 1.5 m | Maximum total weight between two fixing points = 20 kg**

# RAIL RECESSED TRACK – PLANNING EXAMPLE

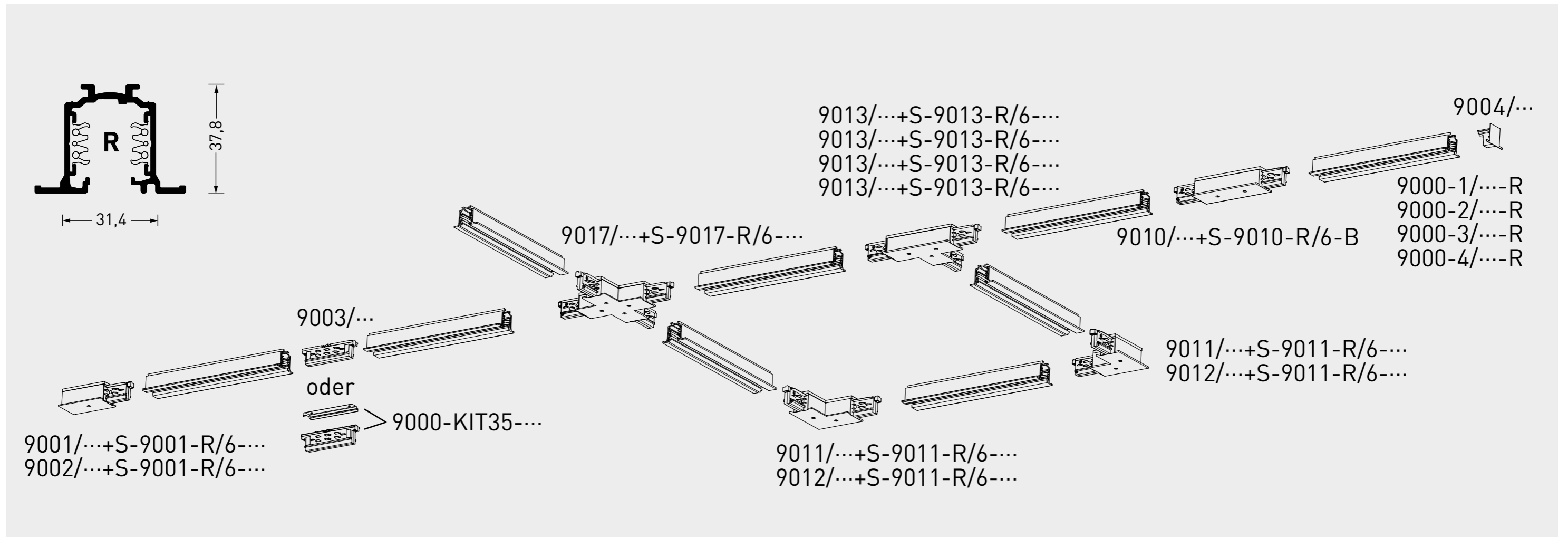



# RAIL FLUSH-MOUNTED TRACK BLACK

AutoCAD symbols	Designation	Quantity		Designation	Weight	TOC
	9000-4-TR, 4 m, freely shortenable	1		3PH ETDD Recess track 4 m	4.0 kg	8904400
	9000-3-TR, 3 m, freely shortenable	1		3PH ETDD Recess track 3 m	3.0 kg	8904300
	9000-2-TR, 2 m, freely shortenable	1		3PH ETDD Recess track 2 m	2.0 kg	8904200
	9000-1-TR, 1 m, freely shortenable	1		3PH ETDD Recess track 1 m	1.0 kg	8904100
	S-9000-T, piece	1		3PH ETDD Cutting tool	0.3 kg	8881400
	9001	1		3PH ETDD Feeder right	0.1 kg	8881600
	9002	1		3PH ETDD Feeder left	0.1 kg	8881800
	9000 KIT31	1		3PH ETDD Flush-mounted housing feeder	0.2 kg	8897600
	9000 KIT32	1		3PH ETDD Joint connector conductive	1.2 kg	8897800
	KIT-9004/TR	1		3PH ETDD End cap	0.1 kg	8897200
	9011	1		3PH ETDD L-connector left	0.2 kg	8882600
	9012	1		3PH ETDD L-connector right	0.2 kg	8882800
	9000 KIT33	1		3PH ETDD Flush-mounted housing L-connector	1.2 kg	8898200
	9000-KIT37-1.5	1		3PH ETDD Pendulum rod for mounting	0.3 kg	9242700

**Maximum distance between fixing points = 1.5 m | Maximum total weight between two fixing points = 20 kg**

# RAIL FLUSH-MOUNTED TRACK WHITE

AutoCAD symbols	Designation	Quantity		Designation	Weight	TOC
	9000-4-TR, 4 m, freely shortenable	1		3PH ETDD Recess track 4 m	4.0 kg	8902000
	9000-3-TR, 3 m, freely shortenable	1		3PH ETDD Recess track 3 m	3.0 kg	8901900
	9000-2-TR, 2 m, freely shortenable	1		3PH ETDD Recess track 2 m	2.0 kg	8901800
	9000-1-TR, 1 m, freely shortenable	1		3PH ETDD Recess track 1 m	1.0 kg	8901700
	S-9000-T, piece	1		3PH ETDD Cutting tool	0.3 kg	8881400
	9001	1		3PH ETDD Feeder right	0.1 kg	8881700
	9002	1		3PH ETDD Feeder left	0.1 kg	8881900
	9000 KIT31	1		3PH ETDD Flush-mounted housing feeder	0.2 kg	8897700
	9000 KIT32	1		3PH ETDD Joint connector conductive	1.2 kg	8897900
	KIT-9004/TR	1		3PH ETDD End cap	0,0 kg	8897300
	9011	1		3PH ETDD L-connector left	0.2 kg	8882700
	9012	1		3PH ETDD L-connector right	0.2 kg	8882900
	9000 KIT33	1		3PH ETDD Flush-mounted housing L-connector	1.2 kg	8898300
	9000-KIT37-1.5	1		3PH ETDD Pendulum rod for mounting	0.3 kg	9242700

**Maximum distance between fixing points = 1.5 m | Maximum total weight between two fixing points = 20 kg**

# RAIL FLUSH-MOUNTED TRACK (TRIMLESS) – PLANNING EXAMPLE

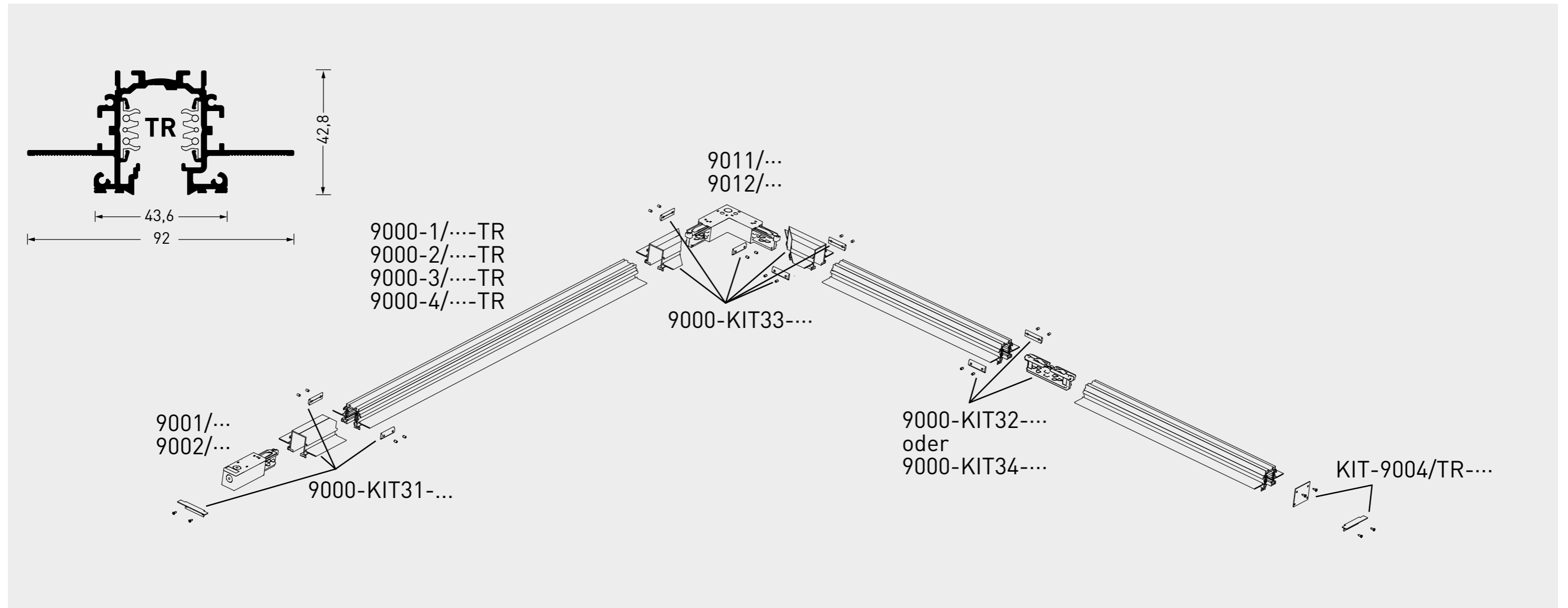

# RAIL HIGH TRACK BLACK (SUSPENDED TRACK WITH INDIRECT COMPONENT)

AutoCAD symbols	Designation	Quantity		Description	Weight	TOC
	HS29	1		3PH ETDD Start module HS29 with feeder and supply line 927	5.3 kg	8905100
	HS29	1		3PH ETDD Start module HS29 with feeder and supply line 930	5.3 kg	8905200
	HS29	1		3PH ETDD Start module HS29 with feeder and supply line 940	5.3 kg	8905300
	HC28	1		3PH ETDD Continuous-line extension module HC28 927	5.3 kg	8905400
	HC28	1		3PH ETDD Continuous-line extension module HC28 930	5.3 kg	8905500
	HC28	1		3PH ETDD Continuous-line extension module HC28 940	5.3 kg	8905600
	HS15	1		3PH ETDD Start module HS15 with feeder and supply line 927	2.6 kg	8904500
	HS15	1		3PH ETDD Start module HS15 with feeder and supply line 930	2.6 kg	8904600
	HS15	1		3PH ETDD Start module HS15 with feeder and supply line 940	2.6 kg	8904700
	HC14	1		3PH ETDD Continuous-line extension module HC14 927	2.6 kg	8904800
	HC14	1		3PH ETDD Continuous-line extension module HC14 930	2.6 kg	8904900
	HC14	1		3PH ETDD Continuous-line extension module HC14 940	2.6 kg	8905000
	S-9000/GP, 1 m, freely shortenable	1		3PH ETDD Blanking cover 1 m	0.3 kg	8881200
	9001-H	1		3PH ETDD Feeder right	0.1 kg	8884200
	9000-H	1		3PH ETDD Feeder left	0.1 kg	8884400
	S-9001/H-C3-93	1		3PH ETDD Cover for feeder	0.1 kg	8898600
	S-9001/H-C3-93 -P	1		3PH ETDD Cover for feeder with hole for supply cable	0.1 kg	8898400
	9000-KIT36	1		3PH ETDD Joint connector conductive	0.2 kg	8900600
	9000-KIT30-1.5	1		3PH ETDD Joint connector conductive with cable suspension 1.5 m	0.2 kg	8900200
	9000-KIT30-3.0	1		3PH ETDD Joint connector conductive with cable suspension 3.0 m	0.2 kg	8900400
	9004/-H	1		3PH ETDD End cap	0.1 kg	8880800
	9011	1		3PH ETDD L-connector left	0.2 kg	8884800
	9012	1		3PH ETDD L-connector right	0.2 kg	8885000
	9013	1		3PH ETDD T-connector left	0.3 kg	8885200
	9014	1		3PH ETDD T-connector right	0.3 kg	8885600
	9015	1		3PH ETDD T-connector left	0.3 kg	8885400
	9016	1		3PH ETDD T-connector right	0.3 kg	8885800
	9017	1		3PH ETDD X-connector	0.4 kg	8886000
	9000-KIT25-1.5	1		3PH ETDD Height-adjustable suspension set 1.5 m	0.1 kg	8899000
	9000-KIT25-3.0	1		3PH ETDD Height-adjustable suspension set 3.0 m	0.1 kg	8899200
	9000-KIT29-1.5	1		3PH ETDD Height-adjustable suspension set 1.5 m	0.1 kg	8899400
	9000-KIT29-3.0	1		3PH ETDD Height-adjustable suspension set 3.0 m	0.1 kg	8899600

Maximum distance between fixing points = 1.5 m | Maximum total weight between two fixing points = 20 kg

# RAIL HIGH TRACK WHITE (SUSPENDED TRACK WITH INDIRECT COMPONENT)

AutoCAD symbols	Designation	Quantity		Description	Weight	TOC
	HS29	1		3PH ETDD Start module HS29 with feeder and supply line 927	5.3 kg	8902700
	HS29	1		3PH ETDD Start module HS29 with feeder and supply line 930	5.3 kg	8902800
	HS29	1		3PH ETDD Start module HS29 with feeder and supply line 940	5.3 kg	8902900
	HC28	1		3PH ETDD Continuous-line extension module HC28 927	5.3 kg	8903000
	HC28	1		3PH ETDD Continuous-line extension module HC28 930	5.3 kg	8903100
	HC28	1		3PH ETDD Continuous-line extension module HC28 940	5.3 kg	8903200
	HS15	1		3PH ETDD Start module HS15 with feeder and supply line 927	2.6 kg	8902100
	HS15	1		3PH ETDD Start module HS15 with feeder and supply line 930	2.6 kg	8902200
	HS15	1		3PH ETDD Start module HS15 with feeder and supply line 940	2.6 kg	8902300
	HC14	1		3PH ETDD Continuous-line extension module HC14 927	2.6 kg	8902400
	HC14	1		3PH ETDD Continuous-line extension module HC14 930	2.6 kg	8902500
	HC14	1		3PH ETDD Continuous-line extension module HC14 940	2.6 kg	8902600
	S-9000/GP, 1 m, freely shortenable	1		3PH ETDD Blanking cover 1 m	0.3 kg	8881300
	9001-H	1		3PH ETDD Feeder right	0.1 kg	8884300
	9000-H	1		3PH ETDD Feeder left	0.1 kg	8884500
	S-9001/H-C3-93	1		3PH ETDD Cover for feeder	0.1 kg	8898700
	S-9001/H-C3-93 -P	1		3PH ETDD Cover for feeder with hole for supply cable	0.1 kg	8898500
	9000-KIT36	1		3PH ETDD Joint connector conductive	0.2 kg	8917900
	9000-KIT30-1.5	1		3PH ETDD Joint connector conductive with cable suspension 1.5 m	0.2 kg	8900300
	9000-KIT30-3.0	1		3PH ETDD Joint connector conductive with cable suspension 3.0 m	0.2 kg	8900500
	9004/-H	1		3PH ETDD End cap	0.1 kg	8881700
	9011	1		3PH ETDD L-connector left	0.2 kg	8884900
	9012	1		3PH ETDD L-connector right	0.2 kg	8885100
	9013	1		3PH ETDD T-connector left	0.3 kg	8885300
	9014	1		3PH ETDD T-connector right	0.3 kg	8885700
	9015	1		3PH ETDD T-connector left	0.3 kg	8885500
	9016	1		3PH ETDD T-connector right	0.3 kg	8885900
	9017	1		3PH ETDD X-connector	0.4 kg	8886100
	9000-KIT25-1.5	1		3PH ETDD Height-adjustable suspension set 1.5 m	0.1 kg	8899100
	9000-KIT25-3.0	1		3PH ETDD Height-adjustable suspension set 3.0 m	0.1 kg	8899300
	9000-KIT29-1.5	1		3PH ETDD Height-adjustable suspension set 1.5 m	0.1 kg	8899500
	9000-KIT29-3.0	1		3PH ETDD Height-adjustable suspension set 3.0 m	0.1 kg	8899700

Maximum distance between fixing points = 1.5 m | Maximum total weight between two fixing points = 20 kg



## PLANNING NOTES

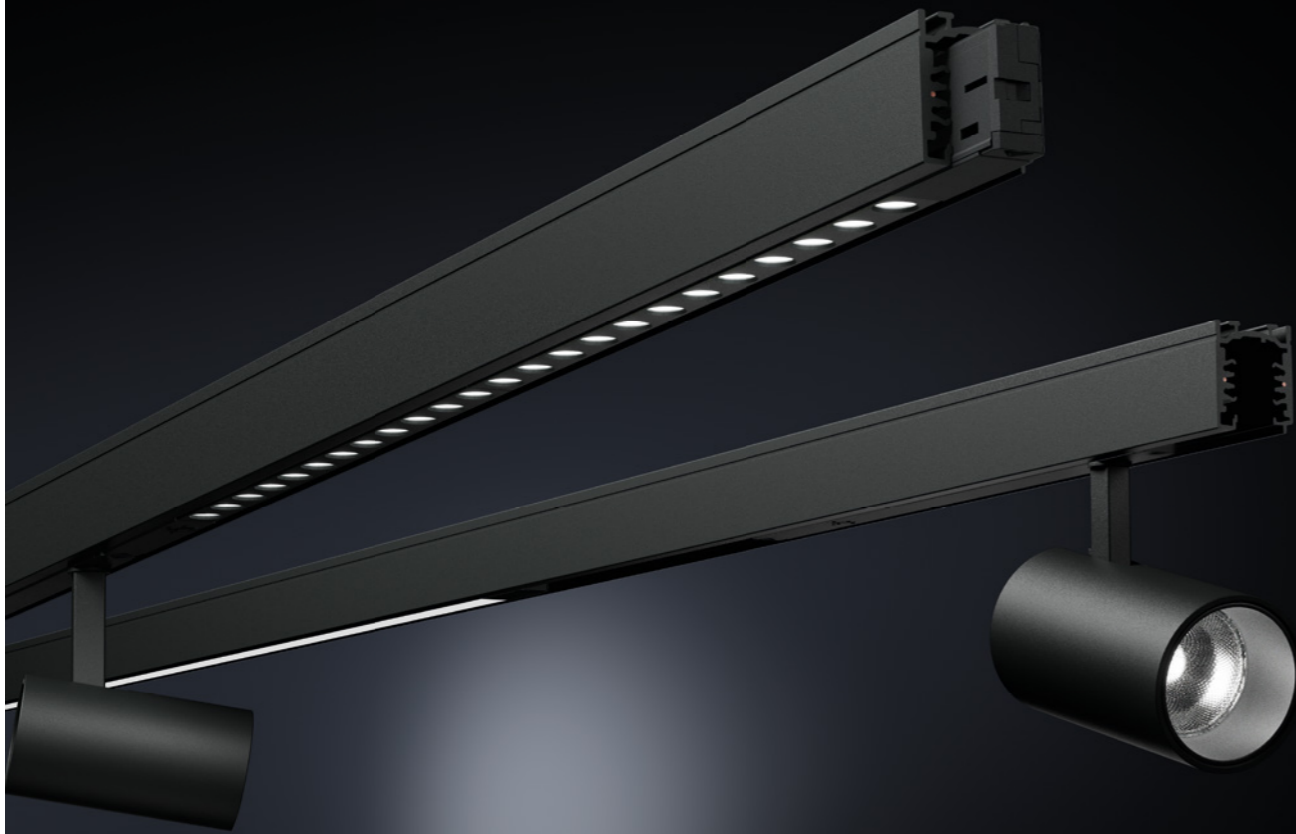

### Product colours of the tracks are colour-coded:

Housing colour white Index 82, colour code 01

Housing colour black Index 160, colour code 05

The formulas for calculating the fixing points help planners to determine the correct number of wires, ceiling clips or caddy clips (for OWA ceilings). The information texts highlighted in grey should be included in the planning / calculation as information for the installer.

### Formula number of fixing points:

Number of running meters of track / 1.5

+ Number of end caps

+ Number of corners

+ Number of T-connectors x2

+ Number of X-connectors x3

= **Sum of required fixing points**

The tracks must be equipped with a fixing point every 1.5 meters! The load on the track between two fixing points must be uniform and must not exceed a total load of 20 kg.

### Formula number of caddy clips:

number of running meters of track / 1.2

+ Number of end caps

+ Number of corners

+ Number of T-connectors x2

+ Number of X-connectors x3

= **Sum of required fixing points**

The maximum load-bearing capacity of the grid ceiling must be taken into account when **spacing the caddy clips**. As a rule, the maximum spacing is 1.25 m/1.20 m, which corresponds to every second crossing point with the trunking profile of the grid ceiling.

## RECTANGULAR ARRANGEMENTS:

When planning the tracks, ensure that the phases and neutral conductor run continuously. Simple rectangles can be formed with 4 identical L-connectors.

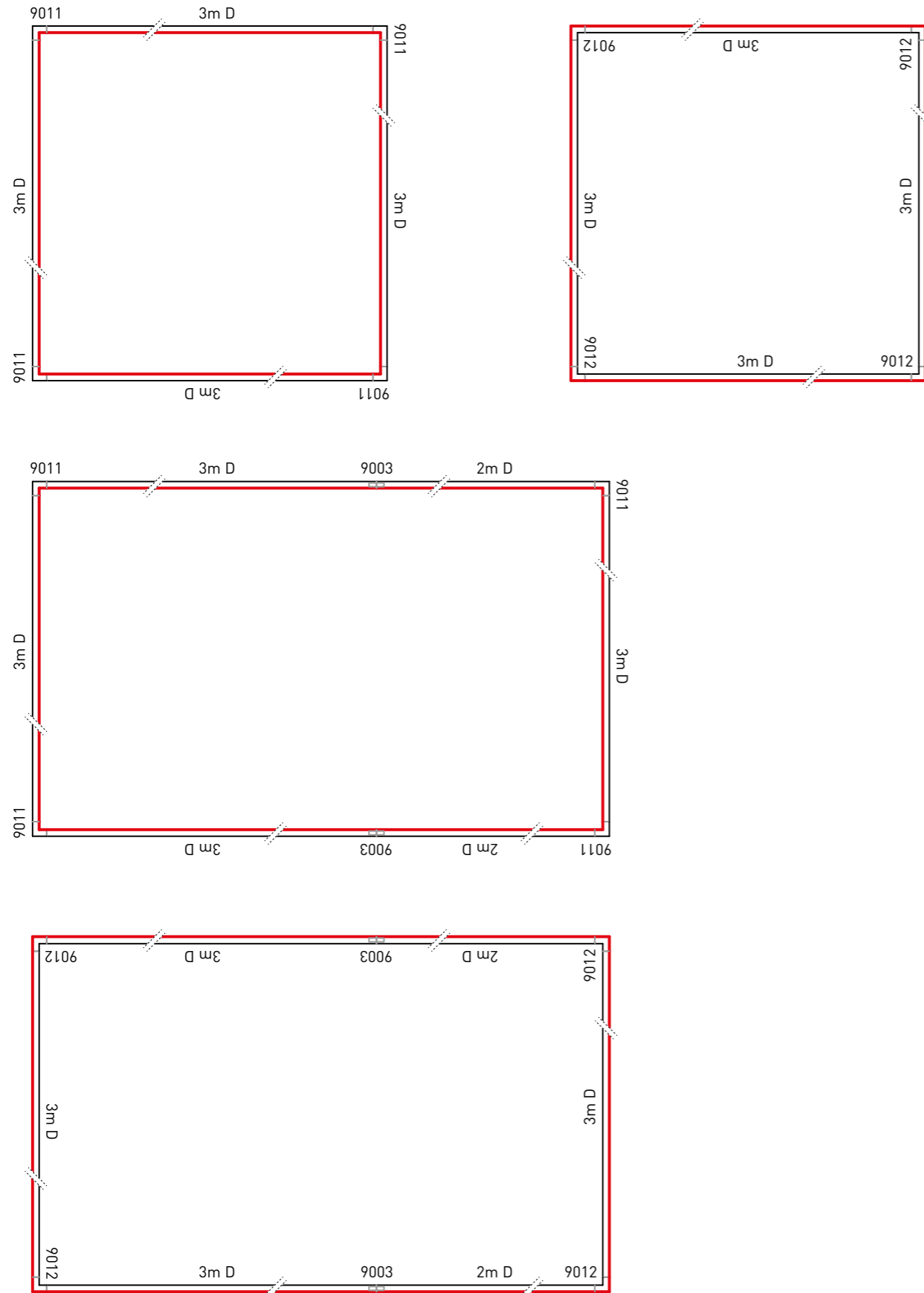

## GRID ARRANGEMENTS:

For simple grid arrangements with a rectangular outer shape, there are always two T-connectors opposite each other, which form a pair. The X-connector that may be required is rotated accordingly.

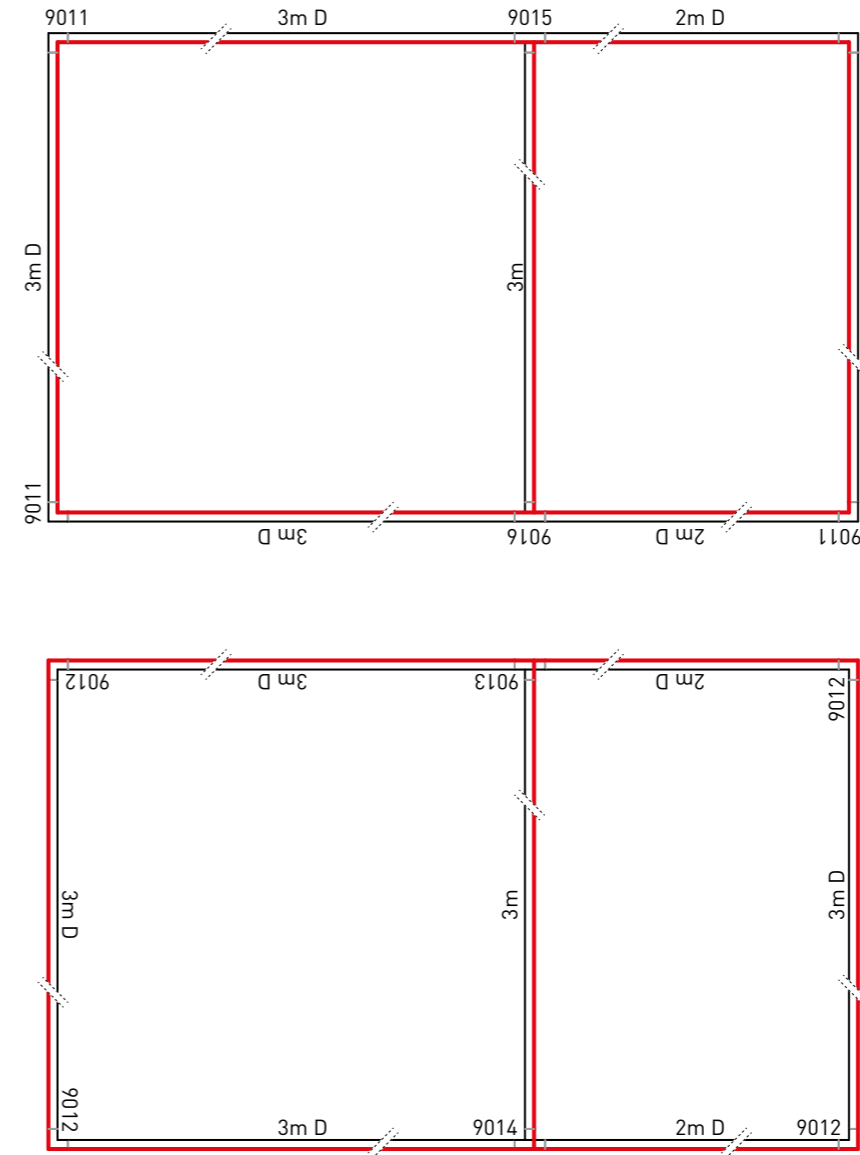

With 9011 corners, 9016 and 9015 are opposite each other, with 9012 corners 9013 and 9014 are opposite each other. These two combinations are also often sufficient for more complex figures.

# FURTHER EXAMPLES

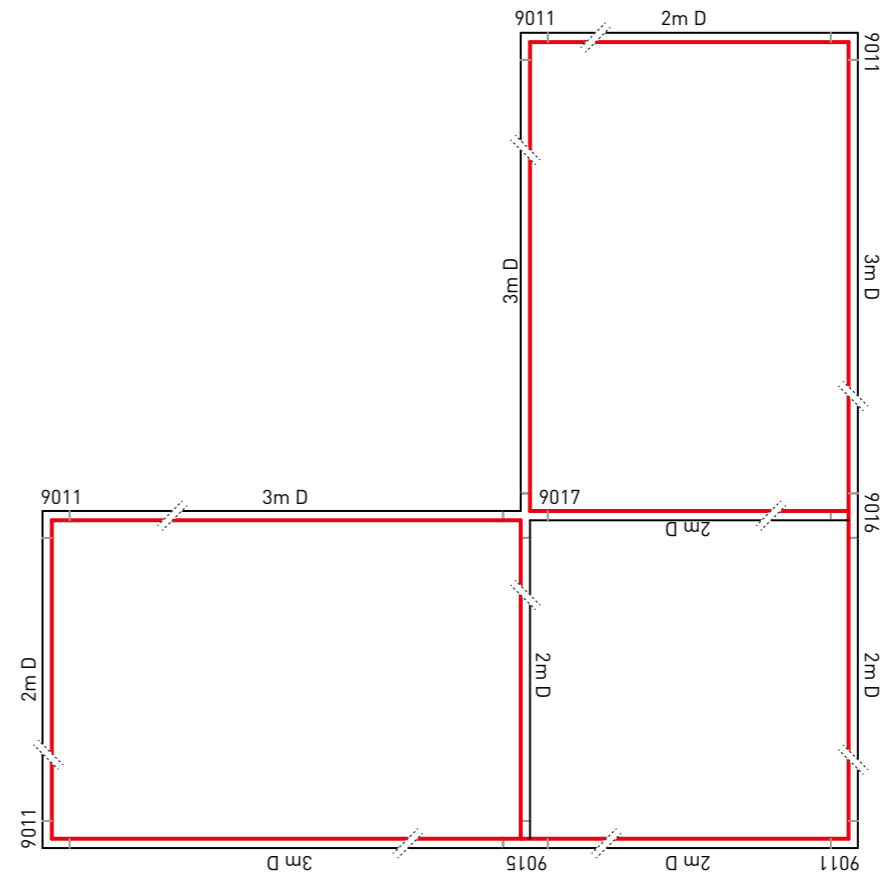
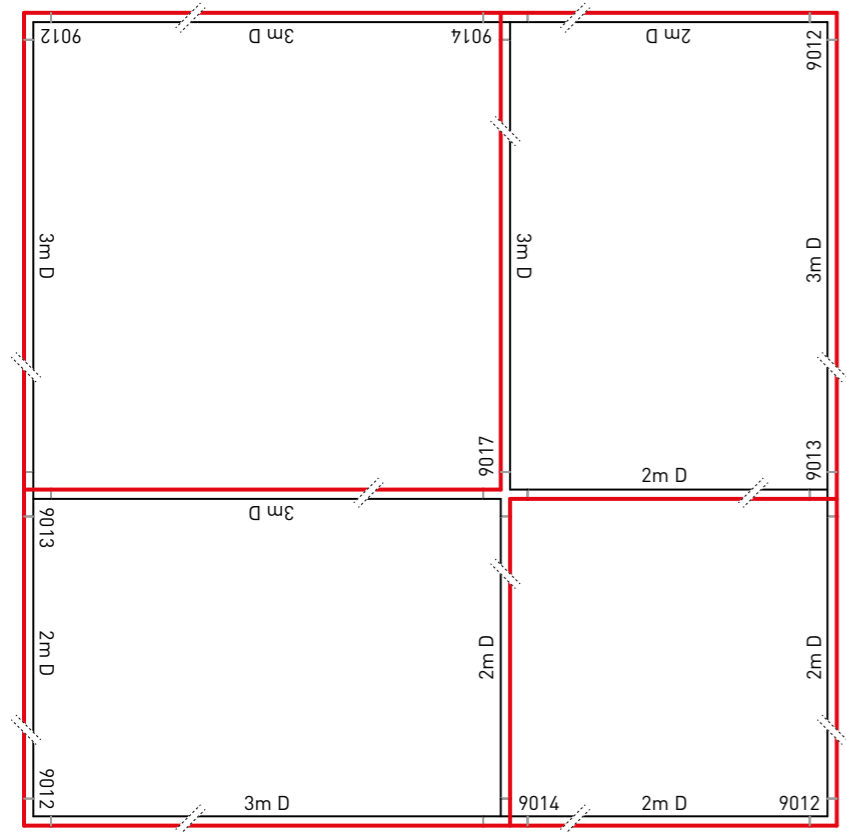
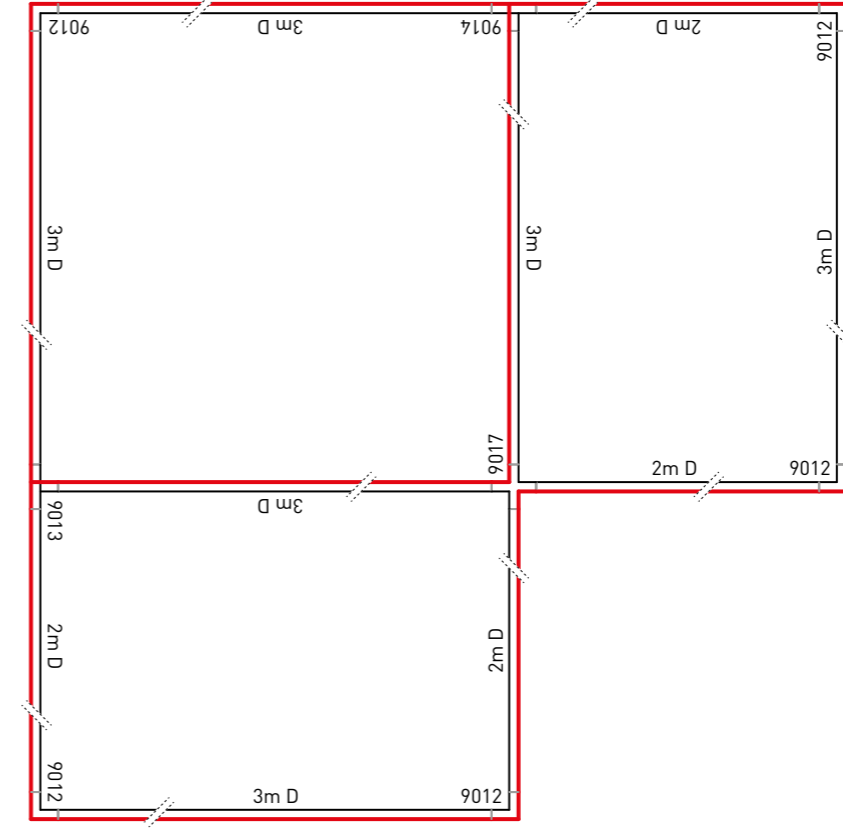
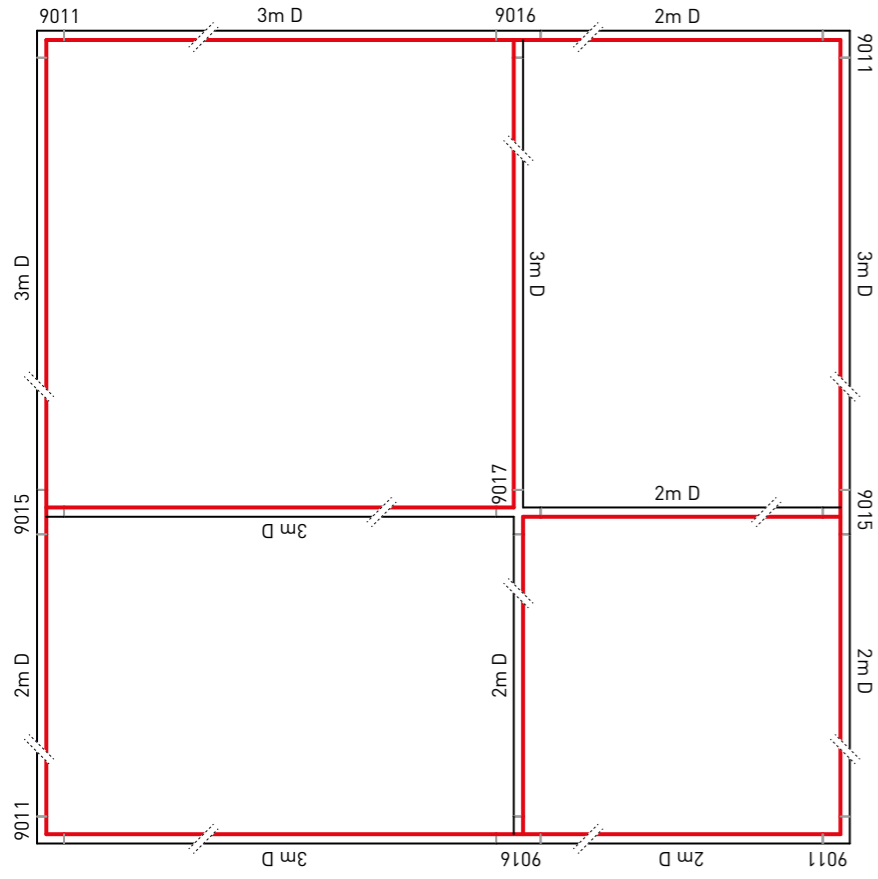

# CONTACTS

## **TRILUX GmbH & Co. KG**

Heidestraße · D-59759 Arnsberg  
Postfach 19 60 · D-59753 Arnsberg  
Tel. +49 2932 301-0  
sales@trilux.com  
www.trilux.com

## **TRILUX LIGHTING LIMITED**

TRILUX HOUSE, Winsford Way  
Boreham Interchange  
Chelmsford, Essex  
CM2 5PD  
Tel. +44 1245 463463  
info.co.uk@trilux.com  
www.trilux.com

All technical data including dimensional and weight specifications have been checked carefully. Errors excepted. We reserve the right to modify in the interest of progress. Luminaires are partly shown with accessories that must be ordered separately. Images of installations may show custom manufactured luminaires.