



**Read the user manual carefully before using the device!** Responsibility for any damage, loss or accidents to persons arising from failure to comply with the warnings in the user manual belongs to the user. In case of malfunctions in this case, the device will be out of warranty.

## ET1224A

### Rail Mounted Four Channel PID Temperature Controller

- Rail mountable box
- Selectable dual set value input
- Selectable TC ( J, K, L, T, S, R ) or two-wire PT100 sensor type (Must be specified in the order)
- Control outputs can be disabled (For measurement purposes)
- Four SSR temperature control outputs
- SSR Outputs can be manually controlled
- Soft-Start feature
- Communication with RS485 Modbus protocol
- Selectable Heating/Cooling control
- Offset feature for input
- In case of probe failure, SSR positions can be selected or run periodically
- Automatic calculation of PID parameters (SELF TUNE)
- Programming with Modbus
- Possibility of heating error monitoring control
- Reading and writing all parameters with NFC
- CE marked according to EN standards



Before starting the system, if the PID parameters are known, they should be entered, if not, the Self-Tune feature should be run.

#### Order Code

ET1224A ...TC Input  
ET1224A-RT ...PT100 Input

## Technical Specifications

### Electrical Specifications

Supply Voltage	24 VDC $\pm$ 20%(The supply cable must be a maximum of 3 meters.)
Power Consumption	Max. 5VA
Connection	1.5mm <sup>2</sup> socket terminal
Scale	<b>For thermocouple:</b> Max. 100 $\Omega$ Ohm, <b>For PT100:</b> Max. 1 $\Omega$ Ohm (Offset parameter may be required for correction.)
Data Protection	EEPROM (at least 10 years)
EMC	EN 61326-1: 2021 (Performance criterion B for EN 61000-4-3 standard is provided.)
Safety Requirements	EN 61010-1: 2010 (Pollution degree 2, overvoltage category II)
 <b>The device should not be used in environments containing flammable and corrosive gases.</b>	

### Environmental Specifications

Ambient/Storage Temperature	0 ...+50°C/-25 ...+70°C (without frost)
Relative Humidity	Up to %80 humidity up to 31°C, then decreases linearly and drops to %50 at 40°C.
Protection Class	IP20 according to EN 60529 standard.
Height	Up to 2000m.
 <b>Cleaning agents containing solvents (thinner, gasoline, etc.) should not be used.</b>	

### Inputs

T1...T4 Thermocouple Input	Four channels, user-selectable J, K, L, T, S, R sensor inputs (for TC input device).
PT1 Idots PT4 PT100 Thermocouple Input	Four channels, PT100 sensor inputs (for PT100 input device).

### Outputs

S1...S4 SSR Control Outputs	Four channels, 24 VDC $\pm$ 20 percent max. 30mA short-circuit protected SSR control output.
-----------------------------	----------------------------------------------------------------------------------------------

**Control**

Control Mode	Single setpoint control.
Control Method	On-Off / P, PI, PD, PID (selectable).
A/D Converter	14 bit
Sampling Time	200ms (Minimum)
Proportional Band	Adjustable between %0.0 and %100.0. If Pb=%0.0, On-Off control is selected.
Integral Time	Adjustable between 0.0 and 100.0 minutes.
Derivative Time	Adjustable between 0.00 and 25.00 minutes.
Control Period	Adjustable between 1 and 125 seconds.
Hysteresis	Adjustable between 1 and 50°C/°F.
Output Power	The ratio in the set value can be adjusted between %0 and %100.

**Box**

Type	Rail mount (DIN 43700)
Dimensions	W22.5xH96xD86mm
Weight	Approx. 158g (after packing)
Material	Self extinguishing plastics used.

**Analog Inputs**

Input Type		Scale Range		Accuracy
PT100	EN 60751	-199.9 ...600.0°C	-199.9 ...999.9°F	± 0,2% (full scale) ± 1 digit
PT100	EN 60751	-200 ...600°C	-328 ...1112°F	± 0,2% (full scale) ± 1 digit
J (Fe-CuNi)	EN 60584	-30.0 ...600.0°C	-22.0 ...999.9°F	± 0,5% (full scale) ± 1 digit
J (Fe-CuNi)	EN 60584	-30 ...600°C	-22 ...1112°F	± 0,5% (full scale) ± 1 digit
K (NiCr-Ni)	EN 60584	-30.0 ...999.9°C	-22.0 ...999.9°F	± 0,5% (full scale) ± 1 digit
K (NiCr-Ni)	EN 60584	-30 ...1300°C	-22 ...2372°F	± 0,5% (full scale) ± 1 digit
L (Fe-CuNi)	DIN 43710	-30.0 ...600.0°C	-22.0 ...999.9°F	± 0,5% (full scale) ± 1 digit
L (Fe-CuNi)	DIN 43710	-30 ...600°C	-22 ...1112°F	± 0,5% (full scale) ± 1 digit
T (Cu-CuNi)	EN 60584	-30.0 ...400.0°C	-22.0 ...752.0°F	± 0,5% (full scale) ± 1 digit
T (Cu-CuNi)	EN 60584	-30 ...400°C	-22 ...752°F	± 0,5% (full scale) ± 1 digit
S (Pt10Rh-Pt)	EN 60584	-40 ...1700°C	-40 ...3092°F	± 0,5% (full scale) ± 1 digit
R (Pt13Rh-Pt)	EN 60584	-40 ...1700°C	-40 ...3092°F	± 0,5% (full scale) ± 1 digit

## Connection Diagram



**ENDA ET1224A** devices are intended for rail mounted installations. Make sure that the device is used only for intended purpose. The shielding must be grounded on the instrument side. During an installation, all of the cables that are connected to the device must be free of electrical power. The device must be protected against inadmissible humidity, vibrations, severe soiling. Make sure that the operation temperature is not exceeded. All input and output lines that are not connected to the supply network must be laid out as shielded and twisted cables. These cables should not be close to the power cables or components. The installation and electrical connections must be carried out by a qualified staff and must be according to the relevant locally applicable regulations.

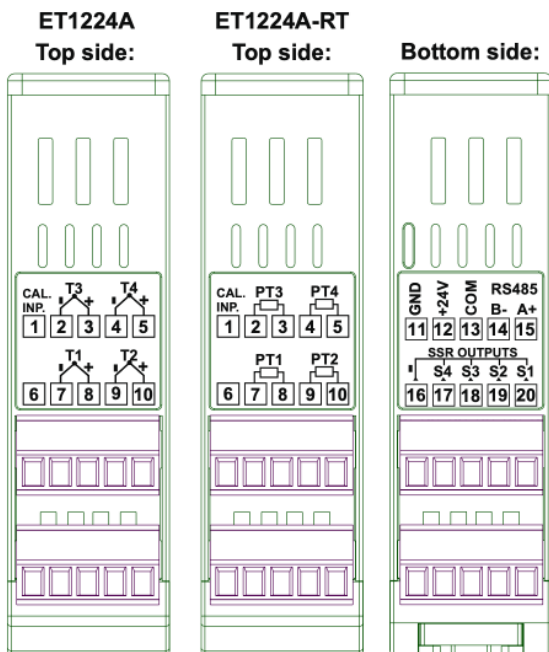

### Error LED Definitions

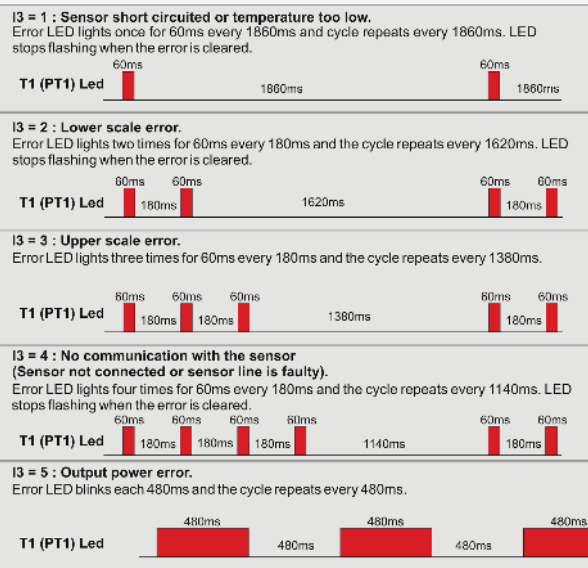

Error LED blinks periodically when an error condition occurs. The charts above are created as sample for T1 (PT1) LED indicator. Similar denotations are valid for T2 (PT2), T3 (PT3) and T4 (PT4) LED indicators.



- 1- Power cables must comply with IEC 60277 or IEC 60245 requirements.
- 2- According to safety rules, the mains switch must be located in a position that the operator can easily reach and must have a sign indicating that the switch is related to the device.

<b>Sensor Input</b>		<b>Mains Connections:</b>	
<p><b>ET1224A Input Connection</b></p>	<ul style="list-style-type: none"> <li>• <b>For J-K-T-S-R type thermocouples:</b> Use the correct compensation cable. Do not make any additional connections. Connect the thermocouple cables to the input terminals by paying attention to the correct connection points.</li> </ul>	<p><b>NOTE :</b> <b>SUPPLY :</b> 21,6-26,4V DC 1A</p> <p>Fuse should be connected.</p> <p>Cable Size 1.5mm<sup>2</sup></p> <p>Supply 24V DC</p> <p>Ground protection input must be connected to the earth line.</p>	
<p><b>ET1224A-RT Input Connection</b></p>	<ul style="list-style-type: none"> <li>• <b>For Resistance Thermometer:</b> Use the 2-wire PT100 sensor cable without making any additional connections. Extending the cable will cause the temperature to be measured incorrectly high.</li> </ul>		



The logic output of the device is not electrically isolated. Therefore, when grounded thermocouples are used, the logic output terminals should not be grounded.

## Connection Diagram Example

### S1, S2, S3, S4 SSR Çıkışlar:

Four SSR control outputs can drive loads up to 30mA 24VDC. SSR outputs are short circuit protected.

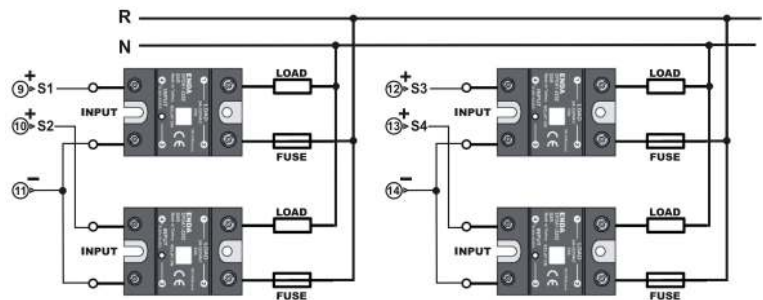

## Dimensions and Assembly

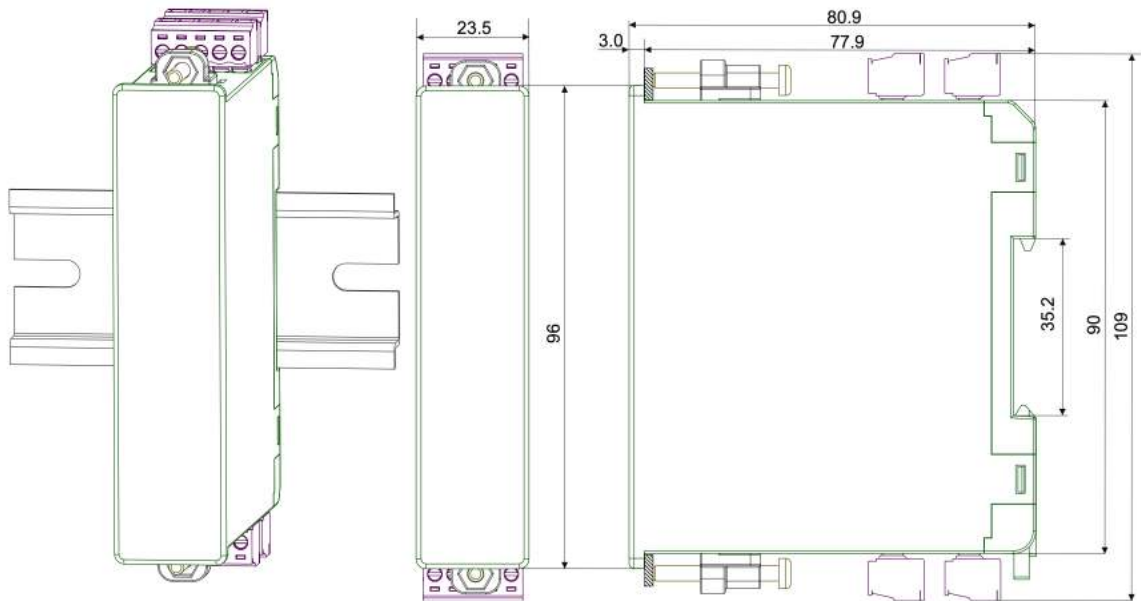

**NOTE:** The unit of measurement is millimeters.

## Alarm Output Types

Following chart indicates the alarm output status for the D1 parameter number and it is sampled for CH1.

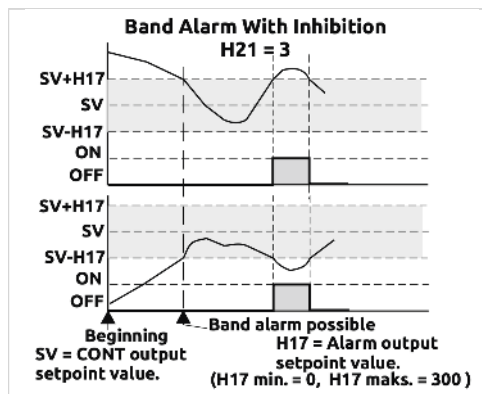
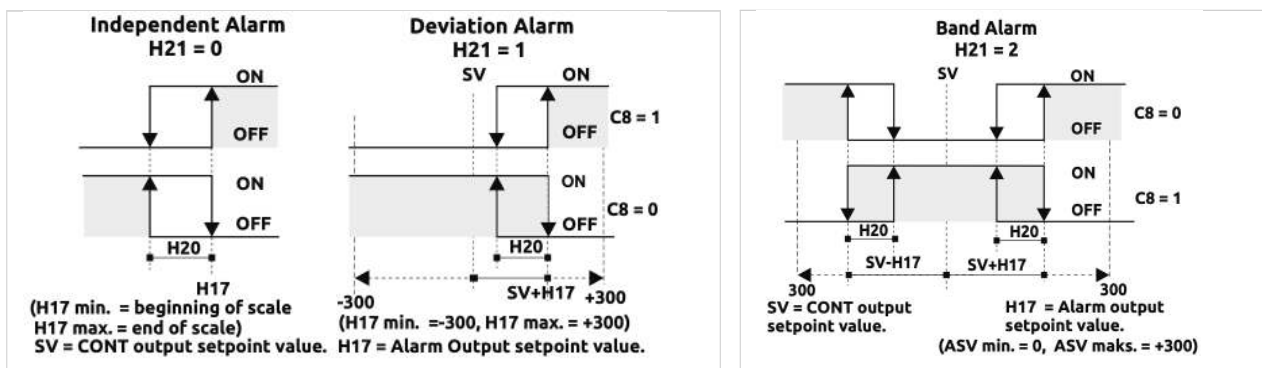

## ET1224A Rail Mounted Four Channel PID Temperature Controller Modbus Map

### Holding Registers

Param	Register Addresses		Data Type	Description	Permission	Default
	Decimal	Hex				
H0	0	0x0000	word	<p><b>ET1224A:</b> Sensor selection parameter for input T1</p> <p>0: J decimal 1: J 2: K decimal 3: K 4: L decimal 5: L 6: T decimal 7: T 8: S 9: R</p> <p><b>ET1224A-RT:</b> Sensor selection parameter for input PT1</p> <p>0: PT100 decimal 1: PT100</p>	Readable Writable	1   1
H1	1	0x0001	word	Filter coefficient for input T1 (Adjustable between 1 and 100, 1 = filter is disable)	Readable Writable	20
H2	2	0x0002	word	Offset value for input T1 (Adjustable between -100 and 100)	Readable Writable	0
H3	3	0x0003	word	S1 output, temperature setpoint value (Adjustable between H5 and H6)	Readable Writable	400
H4	4	0x0004	word	S1 output, 2nd temperature setpoint value (Adjustable between H5 and H6)	Readable Writable	500
H5	5	0x0005	word	S1 output, minimum setpoint value (Adjustable between lower scale and H6)	Readable Writable	0
H6	6	0x0006	word	S1 output, maximum setpoint value (Adjustable between H5 and upper scale)	Readable Writable	600
H7	7	0x0007	word	S1 output, proportional band set value (Adjustable between %0.0 - %100.0)	Readable Writable	4.0
H8	8	0x0008	word	S1 output, hysteresis value (Adjustable between 1 and 50 °C or °F)	Readable Writable	2
H9	9	0x0009	word	S1 output, integral time (Adjustable between 0.0 and 100.0 minute)	Readable Writable	4.0

Param	Register Addresses		Data Type	Description	Permission	Default
	Decimal	Hex				
H10	10	0x000A	word	S1 output, derivative time (Adjustable between 0.00 and 25.00 minute)	Readable Writable	1.00
H11	11	0x000B	word	S1 output, time period setpoint value (Adjustable between 1 and 125 second)	Readable Writable	1
H12	12	0x000C	word	S1 output, set value power ratio (Adjustable between %0.0 and %100.0)	Readable Writable	0.0
H13	13	0x000D	word	S1 output, set value power ratio in case of sensor failure (Adjustable between %0.0 and %100.0)	Readable Writable	0.0
H14	14	0x000E	word	S1 output, Soft start timer (Adjustable between 0 and 250 minutes)	Readable Writable	0
H15	15	0x000F	word	S1 output, percentage of manual output (Adjustable between %0.0 and %100.0)	Readable Writable	50.0
H16	16	0x0010	word	Function control parameters (23040d ( 5A00h ) self tune stops when this value is entered) ( 23041d ( 5A01h ) self tune starts when this value is entered) ( 23042d ( 5A02h ) returns to CH1 parameters factory defaults when this value is entered)	Readable Writable	0
H17	17	0x0011	word	Alarm temperature set value for input T1 (Adjustable between H18 and H19)	Readable Writable	500
H18	18	0x0012	word	Lower limit value for alarm set point (Adjustable between lower scale and H19)	Readable Writable	0
H19	19	0x0013	word	Upper limit value for alarm set point (Adjustable between H18 and upper scale)	Readable Writable	600
H20	20	0x0014	word	Alarm hysteresis value (Adjustable between 1 and 50 °C or °F.)	Readable Writable	2
H21	21	0x0015	word	Alarm output type selection 0: Independent alarm 1: Deviation alarm 2: Band alarm 3: Active alarm after in band time	Readable Writable	0
H22	22	0x0016	word	S1 output heating control time (If 0, output heating error control is not performed. Values up to 1000 seconds can be entered. If the temperature change is not provided at the end of the time, an error message is generated.)	Readable Writable	60

Param	Register Addresses		Data Type	Description	Permission	Default
	Decimal	Hex				
H50	50	0x0032	word	<p><b>ET1224A:</b> Sensor selection parameter for input T2</p> <p>0: J decimal 1: J 2: K decimal 3: K 4: L decimal 5: L 6: T decimal 7: T 8: S 9: R</p> <p><b>ET1224A-RT:</b> Sensor selection parameter for input PT2</p> <p>0: PT100 decimal 1: PT100</p>	Readable Writable	1   1
H51	51	0x0033	word	Filter coefficient for input T2 (Adjustable between 1 and 100, 1 = filter is disable)	Readable Writable	20
H52	52	0x0034	word	Offset value for input T2 (Adjustable between -100 and 100)	Readable Writable	0
H53	53	0x0035	word	S2 output, temperature setpoint value (Adjustable between H55 and H56)	Readable Writable	400
H54	54	0x0036	word	S2 output, 2nd temperature setpoint value (Adjustable between H55 and H56)	Readable Writable	500
H55	55	0x0037	word	S2 output, minimum setpoint value (Adjustable between lower scale and H56)	Readable Writable	0
H56	56	0x0038	word	S2 output, maksimum setpoint value (Adjustable between H55 and upper scale)	Readable Writable	600
H57	57	0x0039	word	S2 output, proportional band set value (Adjustable between %0.0 - %100.0)	Readable Writable	4.0
H58	58	0x003A	word	S2 output, hysteresis value (Adjustable between 1 and 50 °C or °F)	Readable Writable	2
H59	59	0x003B	word	S2 output, integral time (Adjustable between 0.0 and 100.0 minute)	Readable Writable	4.0
H60	60	0x003C	word	S2 output, derivative time (Adjustable between 0.00 and 25.00 minute)	Readable Writable	1.00
H61	61	0x003D	word	S2 output, time period setpoint value (Adjustable between 1 and 125 second)	Readable Writable	1

Param	Register Addresses		Data Type	Description	Permission	Default
	Decimal	Hex				
H62	62	0x003E	word	S2 output, set value power ratio (Adjustable between %0.0 and %100.0)	Readable Writable	0.0
H63	63	0x003F	word	S2 output, set value power ratio in case of sensor failure (Adjustable between %0.0 and %100.0)	Readable Writable	0.0
H64	64	0x0040	word	S2 output, Soft start timer (Adjustable between 0 and 250 minutes)	Readable Writable	0
H65	65	0x0041	word	S2 output, percentage of manual output (Adjustable between %0.0 and %100.0)	Readable Writable	50.0
H66	66	0x0042	word	Function control parameters (23040d ( 5A00h ) self tune stops when this value is entered) ( 23041d ( 5A01h ) self tune starts when this value is entered) ( 23042d ( 5A02h ) returns to CH2 parameters factory defaults when this value is entered)	Readable Writable	0
H67	67	0x0043	word	Alarm temperature set value for input T2 (Adjustable between H68 and H69)	Readable Writable	500
H68	68	0x0044	word	Lower limit value for alarm set point (Adjustable between lower scale and H69)	Readable Writable	0
H69	69	0x0045	word	Upper limit value for alarm set point (Adjustable between H68 and upper scale)	Readable Writable	600
H70	70	0x0046	word	Alarm hysteresis value (Adjustable between 1 and 50 °C or °F.)	Readable Writable	2
H71	71	0x0047	word	Alarm output type selection 0: Independent alarm 1: Deviation alarm 2: Band alarm 3: Active alarm after in band time	Readable Writable	0
H72	72	0x0048	word	S2 output heating control time (If 0, output heating error control is not performed. Values up to 1000 seconds can be entered. If the temperature change is not provided at the end of the time, an error message is generated.)	Readable Writable	60

Param	Register Addresses		Data Type	Description	Permission	Default
	Decimal	Hex				
H100	100	0x0064	word	<p><b>ET1224A:</b> Sensor selection parameter for input T3</p> <p>0: J decimal 1: J 2: K decimal 3: K 4: L decimal 5: L 6: T decimal 7: T 8: S 9: R</p> <p><b>ET1224A-RT:</b> Sensor selection parameter for input PT3</p> <p>0: PT100 decimal 1: PT100</p>	Readable Writable	1   1
H101	101	0x0065	word	Filter coefficient for input T3 (Adjustable between 1 and 100, 1 = filter is disable)	Readable Writable	20
H102	102	0x0066	word	Offset value for input T3 (Adjustable between -100 and 100)	Readable Writable	0
H103	103	0x0067	word	S3 output, temperature setpoint value (Adjustable between H105 and H106)	Readable Writable	400
H104	104	0x0068	word	S3 output, 2nd temperature setpoint value (Adjustable between H105 and H106)	Readable Writable	500
H105	105	0x0069	word	S3 output, minimum setpoint value (Adjustable between lower scale and H106)	Readable Writable	0
H106	106	0x006A	word	S3 output, maximum setpoint value (Adjustable between H105 and upper scale)	Readable Writable	600
H107	107	0x006B	word	S3 output, proportional band set value (Adjustable between %0.0 - %100.0)	Readable Writable	4.0
H108	108	0x006C	word	S3 output, hysteresis value (Adjustable between 1 and 50 °C or °F)	Readable Writable	2
H109	109	0x006D	word	S3 output, integral time (Adjustable between 0.0 and 100.0 minute)	Readable Writable	4.0
H110	110	0x006E	word	S3 output, derivative time (Adjustable between 0.00 and 25.00 minute)	Readable Writable	1.00
H111	111	0x006F	word	S3 output, time period setpoint value (Adjustable between 1 and 125 second)	Readable Writable	1

Param	Register Addresses		Data Type	Description	Permission	Default
	Decimal	Hex				
H112	112	0x0070	word	S3 output, set value power ratio (Adjustable between %0.0 and %100.0)	Readable Writable	0.0
H113	113	0x0071	word	S3 output, set value power ratio in case of sensor failure (Adjustable between %0.0 and %100.0)	Readable Writable	0.0
H114	114	0x0072	word	S3 output, Soft start timer (Adjustable between 0 and 250 minutes)	Readable Writable	0
H115	115	0x0073	word	S3 output, percentage of manual output (Adjustable between %0.0 and %100.0)	Readable Writable	50.0
H116	116	0x0074	word	Function control parameters (23040d ( 5A00h ) self tune stops when this value is entered) ( 23041d ( 5A01h ) self tune starts when this value is entered) ( 23042d ( 5A02h ) returns to CH3 parameters factory defaults when this value is entered)	Readable Writable	0
H117	117	0x0075	word	Alarm temperature set value for input T3 (Adjustable between H118 and H119)	Readable Writable	500
H118	118	0x0076	word	Lower limit value for alarm set point (Adjustable between lower scale and H119)	Readable Writable	0
H119	119	0x0077	word	Upper limit value for alarm set point (Adjustable between H118 and upper scale)	Readable Writable	600
H120	120	0x0078	word	Alarm hysteresis value (Adjustable between 1 and 50 °C or °F.)	Readable Writable	2
H121	121	0x0079	word	Alarm output type selection 0: Independent alarm 1: Deviation alarm 2: Band alarm 3: Active alarm after in band time	Readable Writable	0
H122	122	0x007A	word	S3 output heating control time (If 0, output heating error control is not performed. Values up to 1000 seconds can be entered. If the temperature change is not provided at the end of the time, an error message is generated.)	Readable Writable	60

Param	Register Addresses		Data Type	Description	Permission	Default
	Decimal	Hex				
H150	150	0x0096	word	<p><b>ET1224A:</b> Sensor selection parameter for input T4</p> <p>0: J decimal 1: J 2: K decimal 3: K 4: L decimal 5: L 6: T decimal 7: T 8: S 9: R</p> <p><b>ET1224A-RT:</b> Sensor selection parameter for input PT4</p> <p>0: PT100 decimal 1: PT100</p>	Readable Writable	1   1
H151	151	0x0097	word	Filter coefficient for input T4 (Adjustable between 1 and 100, 1 = filter is disable)	Readable Writable	20
H152	152	0x0098	word	Offset value for input T4 (Adjustable between -100 and 100)	Readable Writable	0
H153	153	0x0099	word	S4 output, temperature setpoint value (Adjustable between H155 and H156)	Readable Writable	400
H154	154	0x009A	word	S4 output, 2nd temperature setpoint value (Adjustable between H155 and H156)	Readable Writable	500
H155	155	0x009B	word	S4 output, minimum setpoint value (Adjustable between lower scale and H156)	Readable Writable	0
H156	156	0x009C	word	S4 output, maximum setpoint value (Adjustable between H155 and upper scale)	Readable Writable	600
H157	157	0x009D	word	S4 output, proportional band set value (Adjustable between %0.0 - %100.0)	Readable Writable	4.0
H158	158	0x009E	word	S4 output, hysteresis value (Adjustable between 1 and 50 °C or °F)	Readable Writable	2
H159	159	0x009F	word	S4 output, integral time (Adjustable between 0.0 and 100.0 minute)	Readable Writable	4.0
H160	160	0x00A0	word	S4 output, derivative time (Adjustable between 0.00 and 25.00 minute)	Readable Writable	1.00
H161	161	0x00A1	word	S4 output, time period setpoint value (Adjustable between 1 and 125 second)	Readable Writable	1

Param	Register Addresses		Data Type	Description	Permission	Default
	Decimal	Hex				
H162	162	0x00A2	word	S4 output, set value power ratio (Adjustable between %0.0 and %100.0)	Readable Writable	0.0
H163	163	0x00A3	word	S4 output, set value power ratio in case of sensor failure (Adjustable between %0.0 and %100.0)	Readable Writable	0.0
H164	164	0x00A4	word	S4 output, soft start value (Adjustable between 0 and 250 minutes)	Readable Writable	0
H165	165	0x00A5	word	S4 output, percentage of manual output (Adjustable between %0.0 and %100.0)	Readable Writable	50.0
H166	166	0x00A6	word	Function control parameters (23040d ( 5A00h ) self tune stops when this value is entered) ( 23041d ( 5A01h ) self tune starts when this value is entered) ( 23042d ( 5A02h ) returns to CH4 parameters factory defaults when this value is entered)	Readable Writable	0
H167	167	0x00A7	word	Alarm temperature set value for input T4 (Adjustable between H168 and H169)	Readable Writable	500
H168	168	0x00A8	word	Lower limit value for alarm set point (Adjustable between lower scale and H169)	Readable Writable	0
H169	169	0x00A9	word	Upper limit value for alarm set point (Adjustable between H168 and upper scale)	Readable Writable	600
H170	170	0x00AA	word	Alarm hysteresis value (Adjustable between 1 and 50 °C or °F.)	Readable Writable	2
H171	171	0x00AB	word	Alarm output type selection 0: Independent alarm 1: Deviation alarm 2: Band alarm 3: Active alarm after in band time	Readable Writable	0
H172	172	0x00AC	word	S4 output heating control time (If 0, output heating error control is not performed. Values up to 1000 seconds can be entered. If the temperature change is not provided at the end of the time, an error message is generated.)	Readable Writable	60

Param	Register Addresses		Data Type	Description	Permission	Default
	Decimal	Hex				
H200	200	0x00C8	word	Modbus baud rate  0: 2400 bps 1: 4800 bps 2: 9600 bps 3: 19200 bps, 4: 38400 bps, 5: 57600 bps, 6: 115200 bps	Readable Writable	2
H201	201	0x00C9	word	Time to turn off the outputs after the RS485 signal is cut off (Adjustable between 2 and 9999 seconds. ATTENTION !! C10 = 1 for this timing to work.)	Readable Writable	2
H202	202	0x00CA	word	Modbus slave address (Adjustable between 1 and 247)	Readable Writable	1

## Coils

Param	Register Addresses		Data Type	Description	Permission	Default
	Decimal	Hex				
C0	0	0x0000	bit	S1 output configuration  0: Heating control 1: Cooling control	Readable Writable	0
C1	1	0x0001	bit	S1 Control output activation  0: Display mode (Outputs Off) 1: S1 output active	Readable Writable	1
C2	2	0x0002	bit	Temperature setpoint selection for S1.  0: H3 parameters temperature control is performed according to 1: H4 parameters temperature control is performed according to.	Readable Writable	0
C3	3	0x0003	bit	S1 output, manual control bit  0: Automatic control. 1: S1 output is given according to the output percentage in the H15 parameter.	Readable Writable	0
C4	4	0x0004	bit	Self tune control selection  0: Self tune is stopped. 1: Self tune is started.	Readable Writable	0

Param	Register Addresses		Data Type	Description	Permission	Default
	Decimal	Hex				
C5	5	0x0005	bit	In case of T1 probe error, S1 output format selection bit  0: Output is given according to the % value in H13 parameter in case of T1 error. 1: According to the last proportional output value in the set value.	Readable Writable	0
C7	7	0x0007	bit	T1 sensor temperature unit  0: Centigrade 1: Fahrenheit	Readable Writable	0
C8	8	0x0008	bit	Alarm status  0: Alarm on below setpoint. 1: Alarm on above setpoint.	Readable Writable	0
C9	9	0x0009	bit	Position of alarm output in probe failure  0: Alarm output OFF. 1: Alarm output ON.	Readable Writable	0
C10	10	0x000A	bit	RS485 disconnect error check  0: RS485 disconnect error check is off. 1: RS485 disconnect error check is active.	Readable Writable	0
C50	50	0x0032	bit	S2 output configuration  0: Heating control 1: Cooling control	Readable Writable	0
C51	51	0x0033	bit	S2 Control output activation  0: Display mode (Outputs Off) 1: S2 output active	Readable Writable	1
C52	52	0x0034	bit	Temperature setpoint selection for S2  0: H53 parameters temperature control is performed according to 1: H54 parameters temperature control is performed according to.	Readable Writable	0
C53	53	0x0035	bit	S2 output, manual control bit  0: Automatic control. 1: S2 output is given according to the output percentage in the H15 parameter.	Readable Writable	0
C54	54	0x0036	bit	Self tune control selection  0: Self tune is stopped. 1: Self tune is started.	Readable Writable	0

Param	Register Addresses		Data Type	Description	Permission	Default
	Decimal	Hex				
C55	55	0x0037	bit	In case of T2 probe error, S2 output format selection bit  0: Output is given according to the % value in H63 parameter in case of T2 error. 1: According to the last proportional output value in the set value.	Readable Writable	0
C57	57	0x0039	bit	T2 sensor temperature unit  0: Centigrade 1: Fahrenheit	Readable Writable	0
C58	58	0x003A	bit	Alarm status  0: Alarm on below setpoint. 1: Alarm on above setpoint.	Readable Writable	0
C59	59	0x003B	bit	Position of alarm output in probe failure  0: Alarm OFF. 1: Alarm ON.	Readable Writable	0
C100	100	0x0064	bit	Configuration of output S3  0: Heating control 1: Cooling control	Readable Writable	0
C101	101	0x0065	bit	S3 Control output activation  0: Display mode (Outputs Off) 1: S3 output active	Readable Writable	1
C102	102	0x0066	bit	Temperature setpoint selection for S3  0: H103 parameters temperature control is performed according to. 1: H104 parameters temperature control is performed according to.	Readable Writable	0
C103	103	0x0067	bit	S3 output, manual control bit  0: Automatic control. 1: S3 output is given according to the output percentage in the H115 parameter.	Readable Writable	0
C104	104	0x0068	bit	Self tune control selection  0: Self tune is stopped. 1: Self tune is started.	Readable Writable	0

Param	Register Addresses		Data Type	Description	Permission	Default
	Decimal	Hex				
C105	105	0x0069	bit	In case of T3 probe error, S3 output format selection bit  0: Output is given according to the % value in H113 parameter in case of T3 error. 1: According to the last proportional output value in the set value	Readable Writable	0
C107	107	0x006B	bit	T3 sensor temperature unit  0: Centigrade 1: Fahrenheit	Readable Writable	0
C108	108	0x006C	bit	Alarm status  0: Alarm on under set value 1: Alarm on above set value	Readable Writable	0
C109	109	0x006D	bit	Position of alarm output at probe failure  0: Alarm OFF. 1: Alarm ON.	Readable Writable	0
C150	150	0x0096	bit	Configuration of output S4  0: Heating control 1: Cooling control	Readable Writable	0
C151	151	0x0097	bit	S4 Control output activation  0: Display mode (Outputs Off) 1: S4 output active	Readable Writable	1
C152	152	0x0098	bit	Temperature setpoint selection for S4  0: H153 parameters temperature control is performed according to. 1: H154 parameters temperature control is performed according to.	Readable Writable	0
C153	153	0x0099	bit	S4 output, manual control bit  0: Automatic control. 1: S4 output is given according to the output percentage in the H165 parameter.	Readable Writable	0
C154	154	0x009A	bit	Self tune control selection  0: Self tune is stopped. 1: Self tune is started.	Readable Writable	0

Param	Register Addresses		Data Type	Description	Permission	Default
	Decimal	Hex				
C155	155	0x009B	bit	In case of T4 probe error, S4 output format selection bit  0: Output is given according to the % value in H163 parameter in case of T4 error. 1: According to the last proportional output value in the set value.	Readable Writable	0
C157	157	0x009D	bit	T4 sensor temperature unit  0: Centigrade 1: Fahrenheit	Readable Writable	0
C158	158	0x009E	bit	Alarm status  0: Alarm on under set value 1: Alarm on above set value	Readable Writable	0
C159	159	0x009F	bit	Position of alarm output in probe failure  0: Alarm OFF. 1: Alarm ON.	Readable Writable	0

## Discrete Inputs

Param	Register Addresses		Data Type	Description	Permission	Default
	Decimal	Hex				
D0	0	0x0000	bit	S1 Control output status	Readable	0
D1	1	0x0001	bit	Input T1, Alarm status	Readable	0
D2	2	0x0002	bit	S1 output heating fault status (0 = No fault, 1 = No heating possible)	Readable	0
D3	3	0x0003	bit	T1 sensor decimal point status  0: Undotted 1: Dot	Readable	0
D50	50	0x0032	bit	S2 Control output status	Readable	0
D51	51	0x0033	bit	Input T2, Alarm status	Readable	0
D52	52	0x0034	bit	S2 output heating fault status (0 = No fault, 1 = No heating possible)	Readable	0
D53	53	0x0035	bit	T2 sensor decimal point status  0: Undotted 1: Dot	Readable	0
D100	100	0x0064	bit	S3 Control output status	Readable	0
D101	101	0x0065	bit	Input T3, Alarm status	Readable	0

Param	Register Addresses		Data Type	Description	Permission	Default
	Decimal	Hex				
D102	102	0x0066	bit	S3 output heating fault status (0 = No fault, 1 = No heating possible)	Readable	0
D103	103	0x0067	bit	T3 sensor decimal point status 0: Undotted 1: Dot	Readable	0
D150	150	0x0096	bit	S4 Control output status	Readable	0
D151	151	0x0097	bit	Input T4, Alarm status	Readable	0
D152	152	0x0098	bit	S4 output heating fault status (0 = No fault, 1 = No heating possible)	Readable	0
D153	153	0x0099	bit	T4 sensor decimal point status 0: Undotted 1: Dot	Readable	0

## Input Registers

Param	Register Addresses		Data Type	Description	Permission	Default
	Decimal	Hex				
I0	0	0x0000	word	T1 input measured temperature value (decimal value if C6 = 1)	Readable	0
I1	1	0x0001	word	Active temperature set value for S1 output	Readable	0
I2	2	0x0002	word	S1 output power percentage	Readable	0.00
I3	3	0x0003	word	T1 input error codes: 0 = No error, 1 = Sensor short circuit, 2 = Lower scale error, 3 = Upper scale error, 4 = Sensor broken, 5 = Temperature low for type B sensor, 6 = Calibration error	Readable	0
I4	4	0x0004	word	Self tune status codes for S1 0 = No error, 1 = Start temperature is higher than 60% of set value, 2 = Pid parameters are calculated, 3 = Power set parameter is calculated	Readable	0
I50	50	0x0032	word	T2 input measured temperature value (decimal value if C56 = 1)	Readable	0
I51	51	0x0033	word	Active temperature set value for S2 output	Readable	0
I52	52	0x0034	word	S2 output power percentage	Readable	0.00

Param	Register Addresses		Data Type	Description	Permission	Default
	Decimal	Hex				
I53	53	0x0035	word	T2 input error code (See T1 error codes for error codes)	Readable	0
I54	54	0x0036	word	Self tune status codes for S2 (See S1 Self tune status codes for status codes)	Readable	0
I100	100	0x0064	word	T3 input measured temperature value (decimal value if C106 = 1)	Readable	0
I101	101	0x0065	word	Active temperature set value for S3 output	Readable	0
I102	102	0x0066	word	S3 output power percentage	Readable	0.00
I103	103	0x0067	word	T3 input error code (See T1 error codes for error codes)	Readable	0
I104	104	0x0068	word	Self tune status codes for S3 (See S1 Self tune status codes for status codes)	Readable	0
I150	150	0x0096	word	T4 input measured temperature value (decimal value if C156 = 1)	Readable	0
I151	151	0x0097	word	Active temperature set value for S4 output	Readable	0
I152	152	0x0098	word	S4 output power percentage	Readable	0.00
I153	153	0x0099	word	T4 input error code (See T1 error codes for error codes)	Readable	0
I154	154	0x009A	word	Self tune status codes for S4 (See S1 Self tune status codes for status codes)	Readable	0

## Modbus Error Messages

Modbus protocol has two types error, communication error and operating error. Reason of the communication error is data corruption in transmission. Parity and CRC control should be done to prevent communication error. Receiver side checks parity and CRC of the data. If they are wrong, the message will be ignored. If format of the data is true but function doesn't perform for any reason, operating error occurs. ET1224A realizes error and sends error message. Most significant bit of function is changed '1' to indicate error in error message by ET1224A. Error code is sent in data section. ET1224A realizes error type via this message.

### Modbus Error Codes

Error Code	Name	Meaning
01	Illegal Function	The function code received in the query is not an allowable action for the ET1224A. If a Poll Program Complete command was issued, this code indicates that no program function preceded it.
02	Illegal Data Address	The data address received in the query is not an allowable address for ET1224A.
03	Illegal Data Valuea	A value contained in the query data field is not an allowable value for the ET1224A.

### Message Sample:

Structure of command message (Byte Format)

Device Address		(0A)h
Function Code		(01)h
Beginning address of coils	MSB	(04)h
	LSB	(A1)h
Number of coils(N)	MSB	(00)h
	LSB	(01)h
CRC DATA	LSB	(AC)h
	MSB	(63)h

Structure of response message (Byte Format)

Device Address		(0A)h
Function Code		(81)h
Error Code		(02)h
CRC DATA	LSB	(B0)h
	MSB	(53)h

As you see in command message,coil information of (4A1)h = 1185 is required but there isn't any coil with 1185 address.Therefore error code with number(02)(Illegal Data Address)sends.

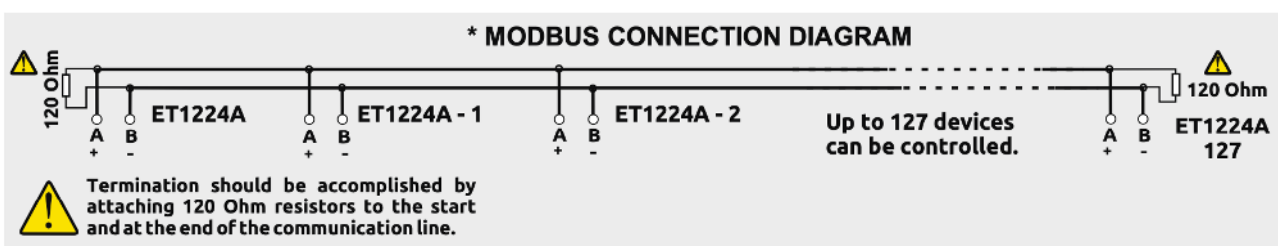

## NFC



**ENDALink**, is a mobile application that provides fast and secure data sharing between NFC supported ENDA devices and mobile devices.

**⚠ To communicate with an NFC supported ENDA device, your mobile device must have NFC support.**

You can access the EndaLink application from Google Play and the App Store by scanning the QR code below.



## Resetting the NFC Password via EndaLink

Password reset can be done in the first 20 seconds after the power on. When the NFC password reset command is sent via EndaLink, the NFC LED lights up. If the NFC password reset is successful, the LED will flash 3 times. If the reset operation fails, no flashing will be produced.

Default NFC Password: 4286