



Read this document carefully before using this device. The guarantee will be expired by device damages if you don't attend to the directions in the user manual. Also we don't accept any compensations for personal injury, material damage or capital disadvantages.

## ENDA EOC9328A OVEN CONTROLLER

Thank you for choosing **ENDA EOC9328A** oven controller.

- 96 x 96mm sized.
- 3 Digits for temperature, 2 Digits for timer indicators.
- On-Off Temperature Control.
- Single J Type Thermocouple Input.
- External Buzzer Output.
- External Phase-Door Input.
- 4 Recipe & Manual mode can be set.
- 7 Relay Output.
- CE Marked according to European Norms.

**Order Code : EOC9328A**



**RoHS  
Compliant**



### TECHNICAL SPECIFICATIONS

Input Type	Temperature Range		Accuracy
	°C	°F	
J (Fe-CuNi) Thermocouple EN 60584	-30....600°C	-22....1112 °F	± 0,5% (of full scale)

#### ENVIRONMENTAL CONDITIONS

Ambient/storage temperature	0 ... +50°C/-25... +70°C (with no icing)	
Max. Relative humidity	Relative humidity 80% for temperatures up to 31°C decreasing linearly to 50% relative humidity at 40°C.	
Rated pollution degree	According to EN 60529	Front panel : IP65, Rear panel : IP20
Height	Max. 2000m	



**KEEP AWAY device from exposed to corrosive, volatile and flammable gases or liquids and DO NOT USE the device in similar hazardous locations.**

#### ELECTRICAL CHARACTERISTICS

Supply	230V AC +%10 -%20, 50/60Hz
Power consumption	Max. 2.6VA
Wiring	Power connector: 2.5mm <sup>2</sup> screw-terminal, Signal connector: 2,5mm <sup>2</sup> screw-terminal conenction.
Line resistance	Max. 100ohm
Data retention	EEPROM (minimum 10 years)
EMC	EN 61326-1: 2013
Safety requirements	EN 61010-1: 2010

#### OUTPUTS

Circulation output	Relay : 250V AC, 5A (for resistive load)
Heating R1 output	Relay : 250V AC, 5A (for resistive load)
Steam Ventilation output	Relay : 250V AC, 5A (for resistive load)
Lighting output	Relay : 250V AC, 5A (for resistive load)
Solenoid (Steam) Valve output	Relay : 250V AC, 5A (for resistive load)
Reduction Gear Output (Left)	Relay : 250V AC, 5A (for resistive load)
Reduction Gear Output (Right)	Relay : 250V AC, 5A (for resistive load)
Life expectancy for relay	30.000.000 Switching for no-load operation; 300.000 switching for 10A resistive load at 250VAC.

#### CONTROL

Control type	Single set-point
Control algorithm	On-Off
A/D converter	12 bit
Sampling time	100ms
Hysteresis	Adjustable between 1 and 50°C/F

#### HOUSING

Housing type	Suitable for flush-panel mounting according to DIN 43 700.
Dimensions	W96xH96xD81mm
Weight	Approx. 250g (after packing)
Enclosure material	Self extinguishing plastics.



**Avoid any liquid contact while the device is switched on. DO NOT clean the device with solvent (thinner, gasoline, acid etc.) and / or abrasive cleaning agents.**

## DIMENSIONS

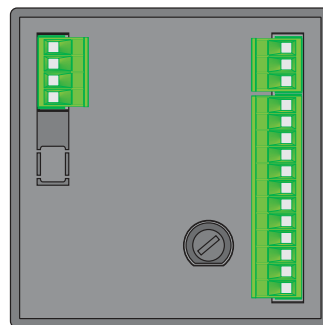
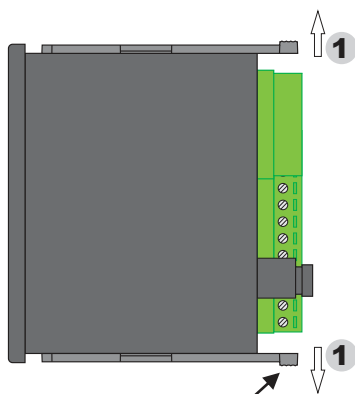
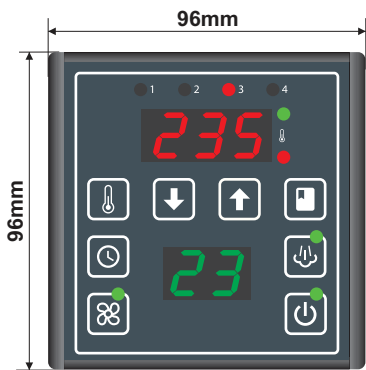

Flush mounting clamp

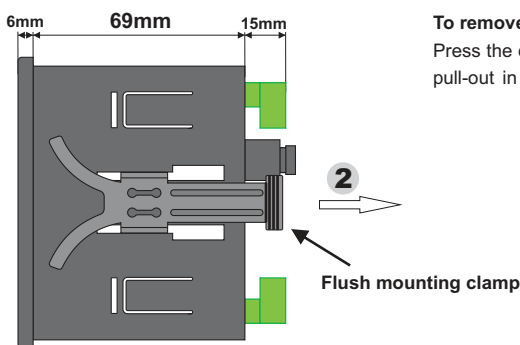
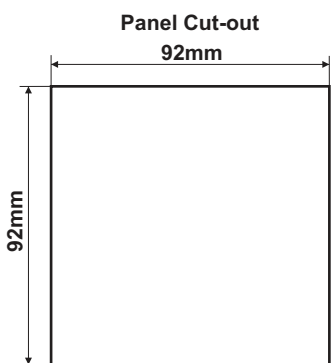

To remove the device from panel :  
Press the clamps outward direction **1** and  
pull-out in direction **2**

- 1) Panel thickness should be maximum 10mm.
- 2) If there is no 60mm free space at the back side of the device, it would be difficult to remove it from the panel.

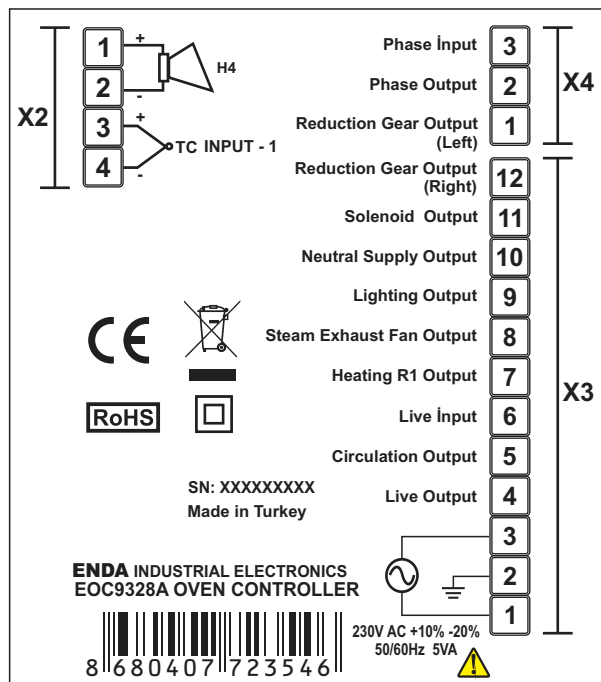
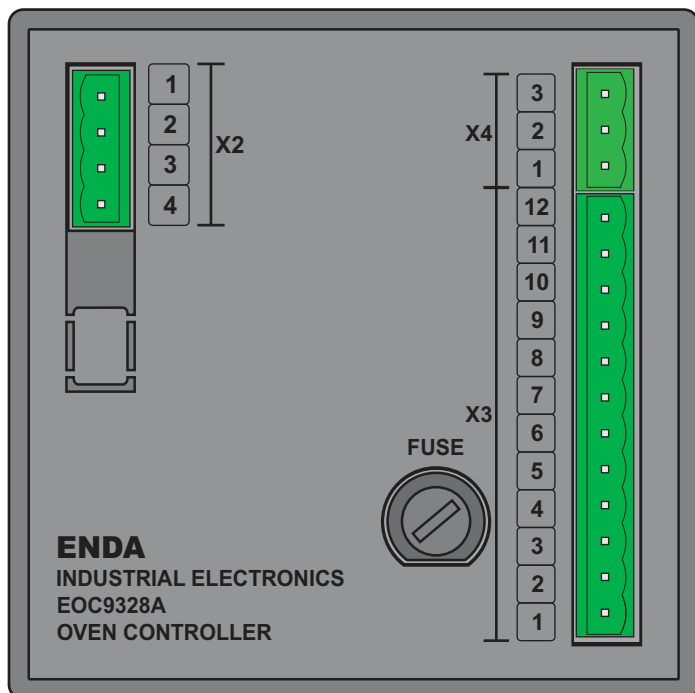



## ACCESSING TO PARAMETER LIST

Password entry is required to programming the device. To access the parameter list, turn off the device and power-up the device by the press and hold the keys. The password menu will be displayed and the code (981) must be entered to accessing the parameter list. Navigate through the menu with & keys. Briefly press for the parameter to be changed. The parameter value is incremented by or decremented by . The scroll speed value is linked to the holding time of the button (the more the holding is long the more the scrolling is faster, the more the holding is short the more the scrolling is slower). Briefly press to save the set value.

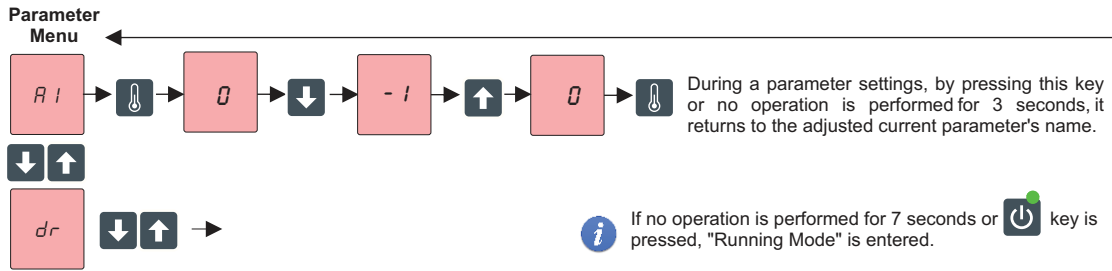

Parameter	PARAMETER LIST	F00 - F07	RANGE
R 1	Offset Thermocouple 1	0	- 15 - 16
P L	Light extinction if door open. [The lighting is managed by terminal X3.9. To avoid short-circuit, the lighting supply must be done before the fuse F 1 (see internal pattern of the controller)]	on	on/OFF
b r	Heating authorized during the steaming (if yes "br" should be set on yes absolutely).	on	on/OFF
b t	Ventilation authorization during the steaming.	on	on/OFF
d t	Ventilation delay after steaming.	30	0 - 60
t r	Heating authorization during the ventilation delay.	oFF	on/OFF
d l	Circulation operating duration (if set to 0, runs continuously and dp parameter will be ignored).	180	0 - 255
d P	Circulation stop time delay.	15	0 - 255
t t L	Reductor output ON time duration (Left).	90	0 - 180
t t r	Reductor output ON time duration (Rght).	90	0 - 180
H i	Maximum setpoint value (max 400°C or 750°F).	280	190°C - 400°C 370°F - 750°F
d i F	Hysteresis ( here switch on the heating when the temperature is 1°C under setpoint, if in °F set on 2°F).	1	1 - 20
E 2	Difference between the setpoint and the thermocouple 1. (The temperature display always shows Tc1).	0	0 - 60
c 0	Heating authorized when remaining cooking time is nil (if yes the heating continues when the timer is up).	on	on/OFF
r 0	Heating authorization except for cooking time (If set to yes, the heater is activated even if the timer has not started. If set to no, the heater is activated only if the timer has started).	on	on/OFF
d r	The time between heating start time after power-up.	0	0 - 15

## POWER SAVING FUNCTION

To setting up the power saving function, enter the password menu and type the code (537) to access the function menu.

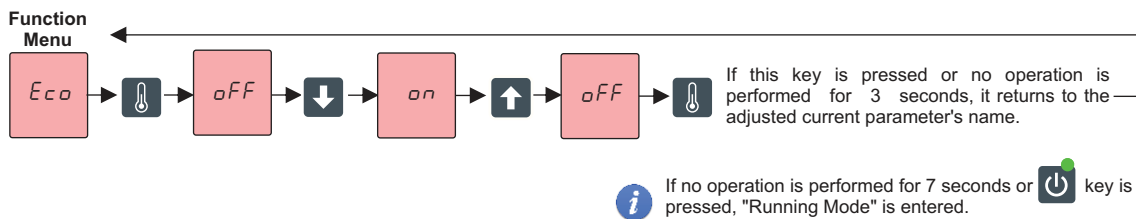

### Power Saving Mode

The device can enter the power saving mode automatically or manually. In automatic mode, the power timer counts when the device is not in use. When the time is up, the device switches to power saving mode. To set this time, it is necessary to enter power saving manually. To enter power saving manually, and keys are held down. After entering the power saving mode, the set value is displayed on the upper screen. This value can be set to 0 or set between 50 and 150. If 0 is set, the device will turn off 1 minute after power saving. If other values are selected, the device maintains the set temperature value. To set up the timer of automatic mode, hold down and the timer is displayed as H.M (hour:minute). The timer can be adjusted by using keys.

## ERROR - WARNING - ALARM DEFINITIONS

**t<sub>c1</sub>** Thermocouple 1 faulty or faults on measurement circuit of tc1





**H5** Faulty Controller, faults on measurement circuit of thermocouples. Service is required.

**o<sub>o</sub>** The controller is on "eco" mode ( power saving).

## USAGE (1/2)

### a) Temperature

Can be adjusted between 0 and  $H_i$  parameter value.

Real temperature (Tc1) or setpoint value can be monitored on the upper display. To shift between selections,   navigation keys must be pressed simultaneously for 5 seconds.  appears on display and the modification is stored. If the  key is pressed during the setpoint value displayed, the real temperature is monitored.

### b) Timer

Can be adjusted between 0 and 99 minutes.

### c) Steam

Can be controlled manually, outside or during the countdown cycle of the timer (adjustable from 0 to 30 seconds).

### d) Recipe Selection



Up to 4 recipe selections can be performed.

#### Recipe Composition

##### 1) A recipe includes the following settings :

- Preheat temperature : Between 0 to  $H_i$  parameter value.
- Cooking temperature : Between 0 to  $H_i$  parameter value.
- Cooking time duration : Between 0 to 99 minutes.
- Steam time duration : Between 0 to 30 seconds.

##### 3) Recipe Selection

To selecting a recipe,  key is pressed once. Valid recipe's led illuminates. If  key is not pressed in 3 seconds, the valid recipe will be selected which is an illuminated recipe.

##### 5) Modifying a Recipe

After the recipe selection,  key is pressed for 3 seconds. Valid (selected) recipe's Led flashes. Preheat temperature, cooking temperature, cooking timing duration and steam timing duration values can be set in the recipe.

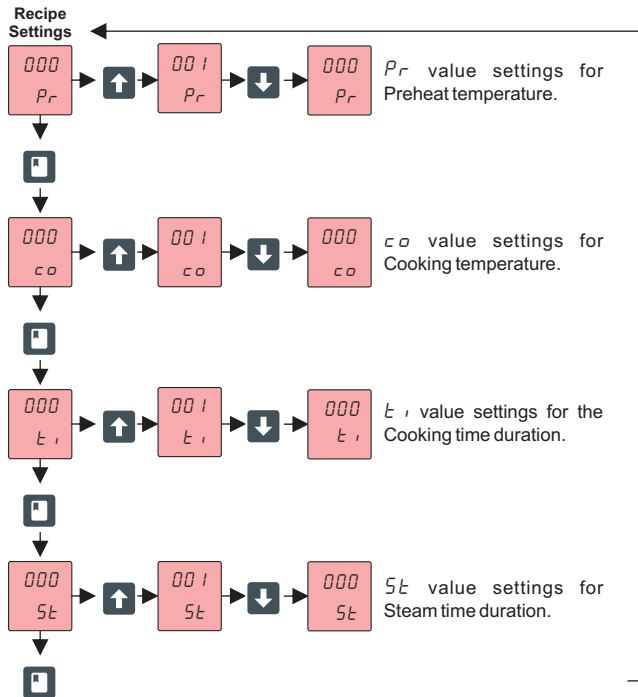

##### 2) Recipe Quantity





4 Recipe types are included on the device. Selected recipe's led illuminates continuously. If no led is lit, the device in manual mode.

##### 4) Accessing to Manual Mode

If pressed to  key, valid recipe's led flashes. Device switches to the manual mode when all LEDs are turned off.





##### For example :





3rd Led illuminates when 3rd recipe is valid. If  key is pressed, the next recipe will be accessed and the 4th Led lit. If  key is pressed again in 4th Led, all LEDs are turned off and manual mode is entered. If  key is pressed again, 1st Led lit.

##### 6) Saving the Recipes

When recipe parameters are modified, press the  button, for 3 seconds saves the modifications. The LED of the corresponding recipe flashes fast and lit continuously when the recipe saved.

#### Setting Up the Temperature (In Recipe or Manual Mode)

**Procedure 1 ;** To adjust the temperature, press one of the   navigation keys the temperature display shows the set temperature if holding the  key, the value increases, if holding the  key the value decreases. The scroll speed value is linked to the holding time of the key (long press to fast scrolling). To set the temperature, press the  key to save it.







**Procedure 2 ;** To adjust the Setpoint when the display shows the real Temperature, press the  key, the display shows the setpoint, if holding down the  key, the value increases, if holding down the  key, the value decreases. The scroll speed value is linked to the holding time of the button (long press to fast scrolling). To set the temperature, press the  key to save it.

The adjusted temperature value is cooking temperature value if the device in manual mode. No preheating feature is available in manual mode. If the recipe is selected and the device is in preheating mode, the set value changes the preheat temperature. If cooking has started, the set value changes the cooking temperature. These changes are not saved when cooking is completed or canceled. In the next operation, the values in the current recipe will be applied.







## USAGE (2/2)

### Adjusting the Timer (In Recipe or Manual Mode)

Can be adjusted between 0 and 99 minutes.

To adjust the timer, press and hold the  key until the lower display indicates the set time, then release the  key. While the set time is monitored on the lower display,  key is pressed and hold again. If holding down the  key, the value increases, if holding down the  key, the value decreases. The scroll speed value is linked to the holding time of the key (long press to fast scrolling). To set the timer, release the  key to save it.

### Steaming Duration (In Manual Mode)

To adjust the duration of the steaming, press and hold together  and  keys until the display shows the set value then release the  key, then adjust the duration with the   keys (long press to fast scrolling). The scroll speed value is linked to the holding time of the key. To set the duration of the steaming, release the  key to save it.

### Operating the Cycle of a Recipe

The preheating is managed independently of the recipes. When device power-on, the preheating mode is started. red Led lit when preheating in progress. green Led lit when the temperature set value is reached. After the recipe selection (*See page 5 / d) Recipe Selection*), open the door, load and press the  key to start the automatic cycle. If the steaming duration is set, the steaming operation starts and the cooking temperature runs stable at the set value. When cooking time over, the buzzer sounds.

During a cooking process, manual steaming, cooking set value(s) and cooking time duration can be changed but applied changes will not be saved.

### Power Interruptions

Remaining cooking time will be stored if the power-loss case occurs. Cooking will continue automatically when the power is returned.