

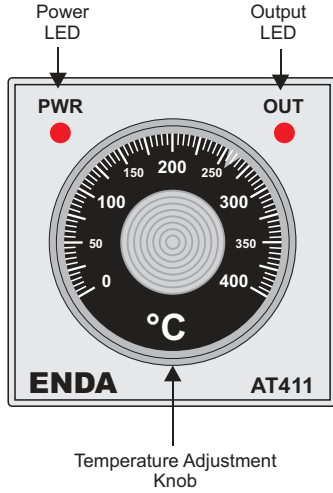

Please read this document carefully before using this product. The guarantee will be invalidated if the device is damaged by not following instructions detailed in the manual. The company shall not be responsible for any damage or losses however caused, which may be experienced as a result of the installation or use of this product.

ENDA AT411 ANALOG THERMOSTAT

Thank you for choosing ENDA AT411 temperature controller.



RoHS
Compliant

- 48x48mm Sized.
- On-Off veya zaman oransal kontrol.
- Fe-Const / NiCr-Ni Thermocouple or PT100 input.
- Relay not operate on sensor failure.
- Adjustable proportional band.
- 8-Pins octal connector or screw terminal connection.
- CE Marked according to European Norms.

Order Code : AT411 - [] - [] - []			
	1	2	3
1 - Sensor Type	230.....230V AC		
	LV.....10-30V DC / 8-24V AC		
2 - Connection Type	K07.....Klemens*		
	S08.....Soketli		
	*Only Fe-Const is used for input.		
3 - Sensor Type		FE400.....Fe-Const 400°C	
		RT400.....PT100 400°C	

Connection Diagram



ENDA AT411 is intended for installation in control panels. Make sure that the device is used only for intended purpose. The electrical connections must be carried out by a qualified staff and must be according to the relevant locally applicable regulations. During an installation, all of the cables that are connected to the device must be free of electrical power. Device must be protected against inadmissible humidity, vibrations, severe soiling and make sure that the operation temperature is not exceeded. The cables should not be close to the power cables or components.

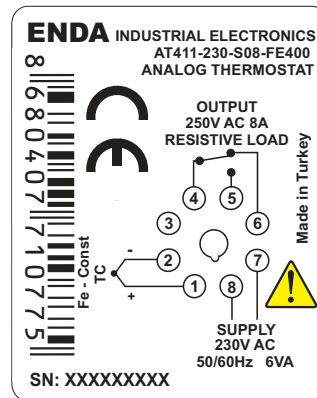
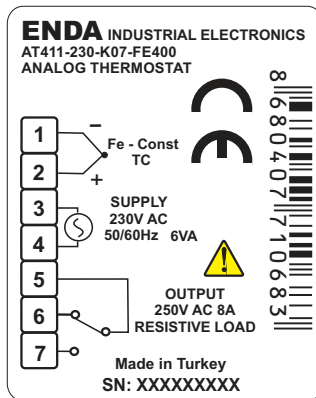

The logic output of the device is not electrically isolated. Therefore, logic output pins should not be grounded when using grounded thermocouples.



- 1) Mains supply cords shall meet the requirements of IEC60227 or IEC60245.
- 2) In accordance with the safety regulations, the power supply switch shall bring the identification of the relevant instrument and it should be easily accessible by the operator.

NOTE : SUPPLY

Fuse should be connected

SENSOR INPUT

Thermocouple Connection :

Use correct compensation cables. Do not use jointed cables. Pay attention to the polarities of the thermocouple cables as shown in the figure.

Resistance Thermometer Connection:

Make short-circuit 2nd and 3rd pinouts of the terminal when two wire PT100 is used.

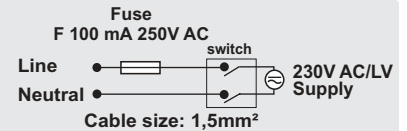

SISEL MÜHENDİSLİK ELEKTRONİK SAN. VE TİC. A.Ş.
Şerifali Mah. Barbaros Cad. No:18 Y.Dudullu 34775
UMRANIYE/İSTANBUL-TURKEY
Tel : +90 216 499 46 64 Pbx. Fax : +90 216 365 74 01
url : www.enda.com.tr



AT411-EN-01-220103

ENVIRONMENTAL CONDITIONS	
Ambient / Storage Temperature	0 ... +50°C/-25 ... 70°C (without icing)
Relative Humidity	Relative humidity 80% for temperatures up to 31°C decreasing linearly to 50% relative humidity at 40°C.
Protection Class	According to EN60529; Front panel : IP65 Rear Panel : IP20
Height	Max. 2000m

⚠ KEEP AWAY device from exposed to corrosive, volatile and flammable gases or liquids and DO NOT USE the device in similar hazardous locations.

ELECTRICAL CHARACTERISTICS	
Supply Voltage	230V AC +%10 -%20, 50/60Hz ;10-30V DC / 8-24V AC ±%10 SMPS
Power Consumption	Maximum 6VA
Connection	8-pins octal connector or screw terminal connection.
Scale	0 ... 400°C / 0 ... 300°C / 0 ... 200°C
Sensitivity	1°C
Accuracy	±%4
EMC	EN 61326-1: 2013
Safety Requirements	EN 61010-1: 2010 (Pollution degree 2, overvoltage category II)

OUTPUTS	
Control Output	Relay : NO+NC 250V AC,8A (resistive load) or 10V DC 10mA logic output.
Life Expectancy	No-load 30.000.000 switching; 250V AC, 8A (resistive load) 300.000 switching.
Control Output Status	OUT Led lit when the control output is energized.

CONTROL	
Control Type	Single-setpoint control.
Control Algorithm	On-Off (Xp=0) or time proportional controls.
Proportional band	0 ... 5% (The adjustment point is on the right side of the device).
Hysteresis	3°C (for On-Off control).

HOUSING	
Housing Type	Suitable for flush -panel mounting
Dimensions	W48xH48xD82mm
Weight	Approx. 170g (After packing)
Enclosure Material	Self extinguishing plastics.

⚠ Avoid any liquid contact while the device is switched on. DO NOT clean the device with solvent (thinner, gasoline, acid etc.) and / or abrasive cleaning agents.

Applications

Plastic injection presses, automatic bread making ovens, nylon bag machines, shrink packing machines, furniture presses, industrial ovens, textile machines, ironing presses and other temperature control applications.

DIMENSIONS

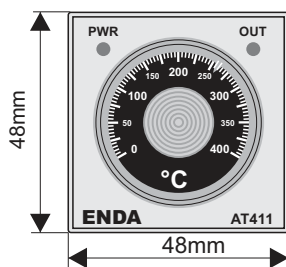

To removing mounting clamps :

- Push the flush-mounting clamp in direction **1** as shown in the figure. Then, pull out the device in direction **2**.

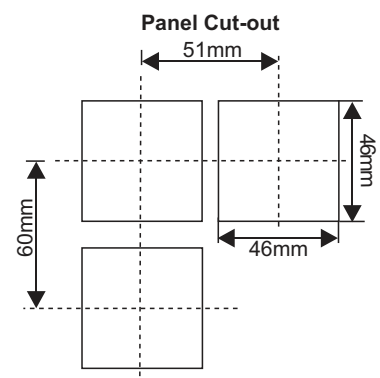
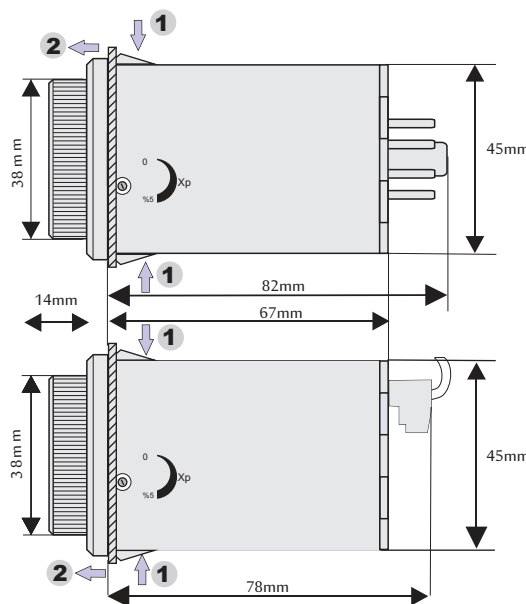

⚠ Panel thickness should be maximum 3mm.



Xp must be set by using a 0.82x 2 mm screwdriver before mounting the device. Otherwise, Xp can not set after the installation.