



Please read this document carefully before using this product. The guarantee will be invalidated if the device is damaged by not following instructions detailed in the manual. The company shall not be responsible for any damage or losses however caused, which may be experienced as a result of the installation or use of this product.

ENDA EUP SERIES PID UNIVERSAL CONTROLLER

Thank you for choosing ENDA EUP Series Universal Controller Devices.

- ▶ Dual setpoint value can be selected.
- ▶ PT100 ,J, K, L, T, S, R sensor (thermocouple) types can be selected.
- ▶ 0-20mA, 4-20mA, 0-10V, 2-10V, 0-25mV and 0-50mV input selections.
- ▶ Auto calculation for PID parameters (SELF TUNE).

Self tune for automatic PID calculation or manually enter PID parameters if known.

- ▶ Three different feature can be assigned to digital input.
- ▶ Three different feature can be assigned to F function key.
- ▶ Soft-Start feature.
- ▶ Analogue, SSR or Relay Output Control selection.
- ▶ 0-20mA and 4-20mA Analogue Output Control selection.
- ▶ Up to 16 steps Profile Control.
- ▶ A1 Relay output programmable as first Alarm or Cooling control output.
- ▶ C/A2 Relay output can be used as second Alarm or Temperature Control output.
- ▶ Heating/Cooling control selection.
- ▶ Zero point input shift.
- ▶ In case of sensor failure, periodically, auto-periodically running or relay state can be selected.
- ▶ RS485 Modbus RTU communication protocol feature (Specify at order).
- ▶ CE marked according to European Norms.



Order Code : EUP

4	2	0	-	-	-
1	2	3			

1 - Size
4420.....48x48x87mm
7420.....72x72x97mm
8420.....48x96x87mm
9420.....96x96x50mm

2 - Supply Voltage
UV.....90-250V AC
LV.....10-30V DC /
8-24V AC

3 - Modbus
RS.....Modbus
(Specify at order)

Please see EUPx420 Series Modbus Address Map and Connection Diagram Guide for Modbus feature.



Input Type	Scale Range	°C	°F	Accuracy
PT100 Resistance Thermometer	EN 60751	-199.9...600.0 °C	-199.9...999.9 °F	± 0,2% (for full scale) ± 1 digit
PT100 Resistance Thermometer	EN 60751	-200...600 °C	-328....1112 °F	± 0,2% (for full scale) ± 1 digit
J (Fe-CuNi) Thermocouple	EN 60584	-30.0....600.0 °C	-22.0....999.9 °F	± 0,5% (for full scale) ± 1 digit
J (Fe-CuNi) Thermocouple	EN 60584	-30....600 °C	-22....1112 °F	± 0,5% (for full scale) ± 1 digit
K (NiCr-Ni) Thermocouple	EN 60584	-30.0....999.9 °C	-22.0....999.9 °F	± 0,5% (for full scale) ± 1 digit
K (NiCr-Ni) Thermocouple	EN 60584	-30....1300 °C	-22....2372 °F	± 0,5% (for full scale) ± 1 digit
L (Fe-CuNi) Thermocouple	DIN 43710	-30.0....600.0 °C	-22.0....999.9 °F	± 0,5% (for full scale) ± 1 digit
L (Fe-CuNi) Thermocouple	DIN 43710	-30....600 °C	-22....1112 °F	± 0,5% (for full scale) ± 1 digit
T (Cu-CuNi) Thermocouple	EN 60584	-30.0....400.0 °C	-22.0....752.0 °F	± 0,5% (for full scale) ± 1 digit
T (Cu-CuNi) Thermocouple	EN 60584	-30....400 °C	-22....752 °F	± 0,5% (for full scale) ± 1 digit
S (Pt10Rh-Pt) Thermocouple	EN 60584	-40...1700 °C	-40....3092 °F	± 0,5% (for full scale) ± 1 digit
R (Pt13Rh-Pt) Thermocouple	EN 60584	-40...1700 °C	-40....3092 °F	± 0,5% (for full scale) ± 1 digit
0-20mA input		-1999...+9999 (max. scale range 10000)		± 0,2% (for full scale) ± 1 digit
4-20mA input		-1999...+9999 (max. scale range 10000)		± 0,2% (for full scale) ± 1 digit
0-10V input		-1999...+9999 (max. scale range 10000)		± 0,2% (for full scale) ± 1 digit
2-10V input		-1999...+9999 (max. scale range 10000)		± 0,2% (for full scale) ± 1 digit
0-25mV input		-1999...+9999 (max. scale range 10000)		± 0,2% (for full scale) ± 1 digit
0-50mV input		-1999...+9999 (max. scale range 10000)		± 0,2% (for full scale) ± 1 digit

ENVIRONMENTAL CONDITIONS

Ambient/storage temperature	0 ... +50°C/-25 ... +70°C
Max. relative humidity	Relative humidity 80% for temperatures up to 31°C decreasing linearly to 50% relative humidity at 40°C.
Rated pollution degree	According to EN 60529; Front panel : IP65, Rear panel : IP20
Height	Max. 2000m

⚠ KEEP AWAY device from exposed to corrosive, volatile and flammable gases or liquids and DO NOT USE the device in similar hazardous locations.

ELECTRICAL CHARACTERISTICS

Supply	90-250V AC 50/60Hz ; 10-30V DC / 8-24V AC SMPS
Power consumption	Max. 5VA
Wiring	Power screw-terminal connections: 2.5mm ² , Signal screw-terminal connections: 1,5mm ² .
Line resistance	Max. 100 Ohm
Data retention	EEPROM (minimum 10 years)
EMC	EN 61326-1: 2013 (Performance criterion B satisfied for EN 61000-4-3 standard).
Safety requirements	EN 61010-1: 2010 (Pollution degree 2, overvoltage category II)

OUTPUTS

C/A2 Output	Relay : 250V AC, 8A (for resistive load), NO+NC (Control or Alarm2 Output selection).
A1 Output	Relay : 250V AC, 8A (for resistive load), NO (Alarm1 and Cooling Control Output selection).
ANL/SSR Output	Max. SSR Output ; 0-20mA, 4-20mA, 24V 20mA. Max. load resistance ; 600 Ohm (12 bit 0.2% accuracy).
Life expectancy for relay	Without load 30.000.000 switching; 250V AC, 8A (resistive load) 300.000 switching.

CONTROL

Control type	Single Setpoint and Alarm Control.
Control algorithm	On-Off / P, PI, PD, PID (selection).
A/D converter	14 bit.
Sampling time	Min. 100ms.
Proportional band	Can be adjusted between %0.0 and %100.0 . If Pb=%0.0 , ON-OFF control is selected.
Control period	Can be adjusted between 1 and 125secs.
Hysteresis	Can be adjusted between 1 and 50°C/F.
Output power	Setpoint value ratio can be adjusted between %0 and %100 .

HOUSING

Housing type	Suitable for flush-panel mounting according to DIN 43 700. EUP4420 : W48xH48xD87mm, EUP7420 : W72xH72xD97mm, EUP8420 : W48xH96xD87mm, EUP9420 : W96xH96xD50mm.
Dimensions	
Weight	Approx. 400g (250g for EUP4400) After packing.
Enclosure material	Self extinguishing plastics

⚠ Avoid any liquid contact when the device is switched on. DO NOT clean the device with solvent (thinner, gasoline, acid etc.) and / or abrasive cleaning agents.



SISEL MÜHENDİSLİK ELEKTRONİK SAN. VE TİC. A.Ş.
Sarıfili Mah. Barbaros Cad. No:18 Y.Dudullu 34775
ÜMRANİYE/İSTANBUL-TÜRKİYE
Tel : +90 216 499 46 64 Pbx. Fax : +90 216 365 74 01
url : www.enda.com.tr

MOTORIZED VALVE CONNECTION AND SETTINGS

Diagram-1

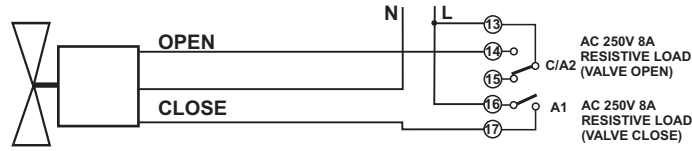

Motorized valve connection must be applied as shown figure above (if the motorized valve electrical values are incompatible with EUPx420 contact output values, an additional contactor must be connected). And $C.a.s.E.$ parameter in the EUPx420 must be selected as $R.c.o.n.$. Full opening time of the motorized valve connected to the device is entered in $R.c.a.t.$ parameter as seconds. Full opening time must be entered to $R.c.c.t.$ parameter as percentage for motorized valve running-up time.

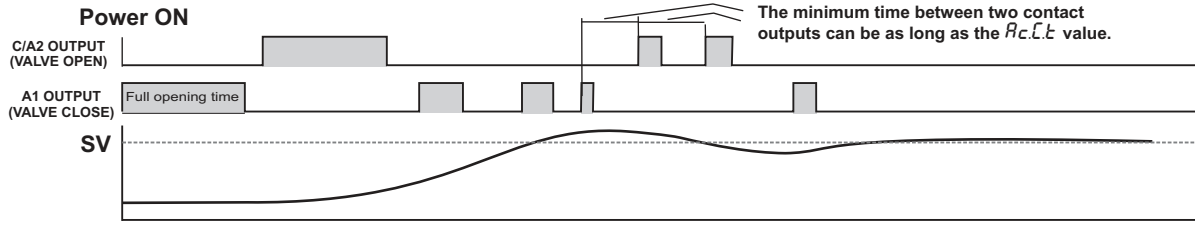

ALARM1 AND ALARM2 OUTPUT TYPES

Diagram-2

Independent Alarm $R.i.t.P.=indE$

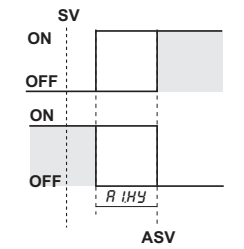

(ASV min. = beginning of scale
ASV max. = end of scale)
SV = CONT output set value

Deviation Alarm $R.i.t.P.=dE.$

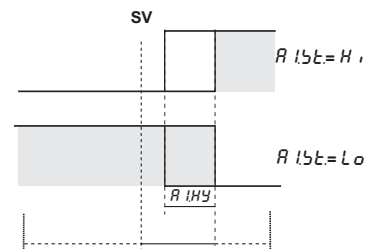

(ASV min. = -300, ASV maks. = +300)
ASV = Alarm output set value

Band Alarm $R.i.t.P.=bA.n.d$

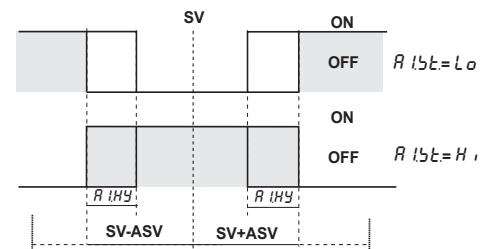

SV = CONT output set value ASV = A1 output set value
(ASV min. = 0, ASV max. = +300)

Band Alarm With Inhibition $R.i.t.P.=bA.n.i.$

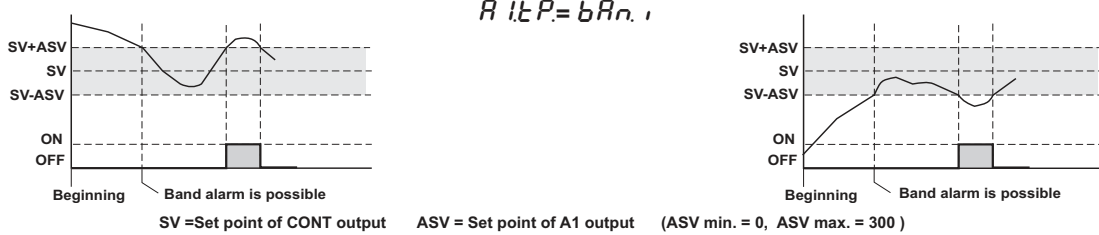

SV = Set point of CONT output ASV = Set point of A1 output (ASV min. = 0, ASV max. = 300)

TIMER / THERMOSTAT OUTPUT DIAGRAMS

Diagram-3

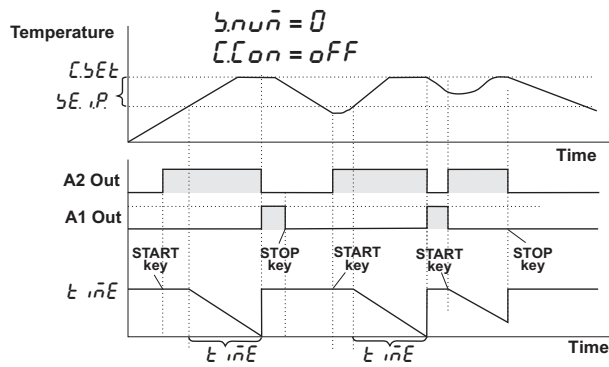
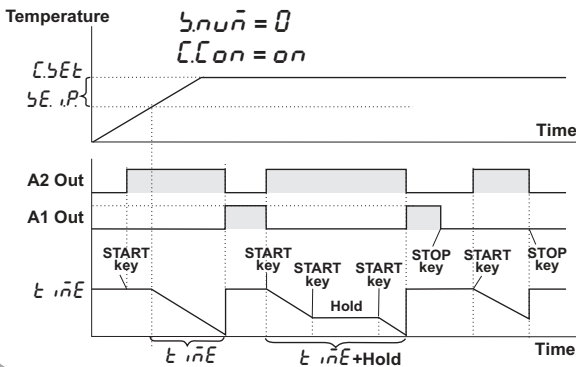

A2 Output runs if the $C.a.s.E.$ parameter is set to 55r, 0-20 or 4-20 and with the $R2P.c.$ parameter is set to on

PROFILE CONTROL OUTPUT DIAGRAMS

Diagram-4

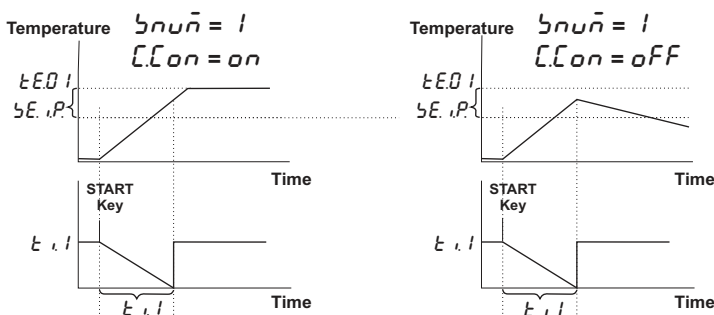

⚠ $C.n.u.n.$ must be set to 1 for single step program.

MULTI-STEP PROFILE CONTROL OUTPUT GRAPHICS

Diagram-5

	Step1	Step2	Step3	Step4	Step5
Target Temperature	$t_{E.01} = 100$	$t_{E.02} = 100$	$t_{E.03} = 300$	$t_{E.04} = 300$	$t_{E.05} = 100$
Time	$t_{i.01} = 30$	$t_{i.02} = 20$	$t_{i.03} = 60$	$t_{i.04} = 40$	$t_{i.05} = 60$
A1	ON	OFF	OFF	ON	OFF
A2	OFF	ON	OFF	ON	OFF

! $b_{n.05}$ parameter should be set to 5 for five step program.

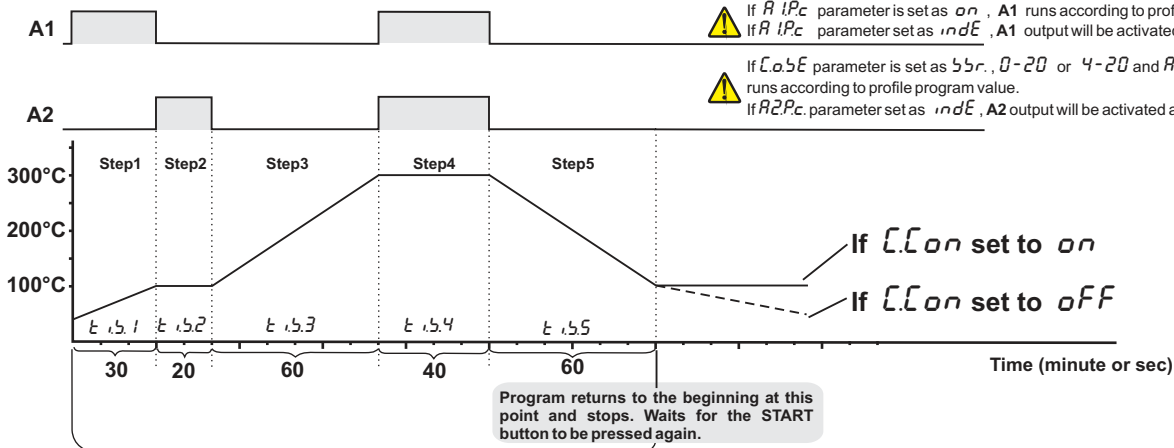

! If $R1Pc$ parameter is set as on , A1 runs according to profile program value.
 If $R1Pc$ parameter set as $indE$, A1 output will be activated according to $R1SE$ value.

! If $L2SE$ parameter is set as $b_{n.0-20}$ or $4-20$ and $R2Pc$ parameter set as on , A2 runs according to profile program value.
 If $R2Pc$ parameter set as $indE$, A2 output will be activated according to $R2SE$ value.

CONNECTION DIAGRAM

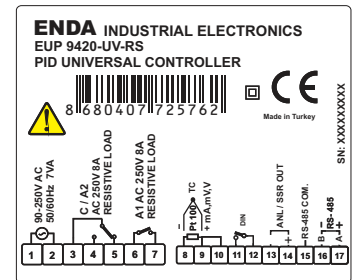
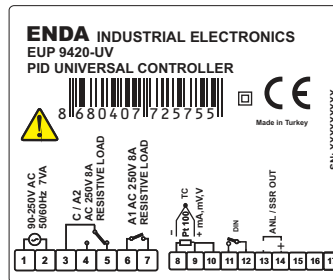
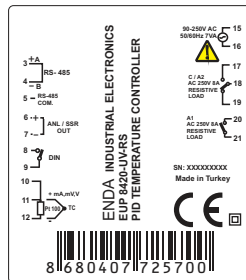
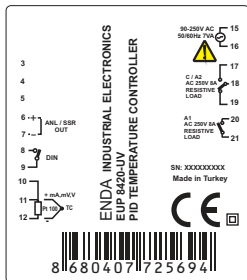
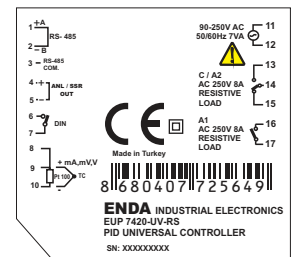
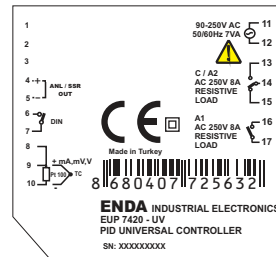
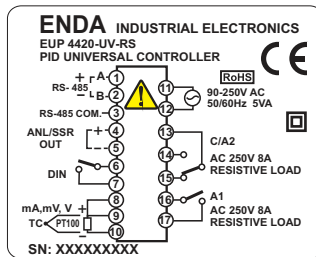
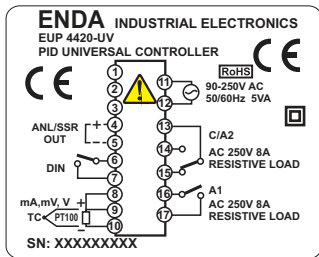

NOTE :

SUPPLY VOLTAGE

	EUP4420	EUP7420	EUP8420	EUP9420
90 - 250V AC veya	(11)	(11)	(15)	(1)
10-30V DC / 8-24V AC	(12)	(12)	(16)	(2)

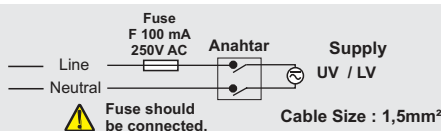

SENSOR INPUT:

For J-K-T-S and R Thermocouples: Use the correct compensating cable. Do not make any supplement to cables. Connect the thermocouple cables to the right places at the input terminal.

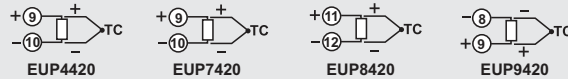

For resistance (PT100) Sensor :

In order to using 2-wire resistance sensors (PT100), 8th and 9th terminals must be short circuited on EUP4420, EUP7420 and EUP9420 devices. Also on EUP8420 devices, 10th and 11th terminals must be short circuited. Please check connection diagrams carefully.



! Holding screw 0.4-0.5Nm

! Equipment is protected throughout by DOUBLE INSULATION.



Logic output of the instrument is not electrically insulated from the internal circuits. Therefore, when using a grounding thermocouple, do not connect the logic output terminals to the ground.

Note :

- 1) Mains supply cords shall meet the requirements of IEC 60227 or IEC 60245.
- 2) In accordance with the safety regulations, the power supply switch shall bring the identification of the relevant instrument and it should be easily accessible by the operator.

DIMENSIONS

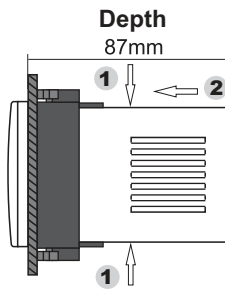
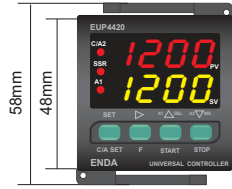

To removing the device from the panel:
- While pressing both side of the device in direction **1** and push it in direction **2**.

Connection Cables
Ambient temperature sensor

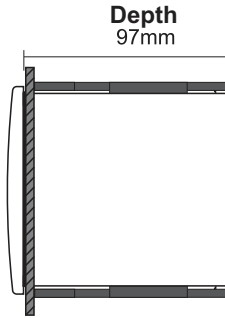
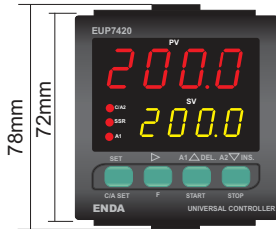
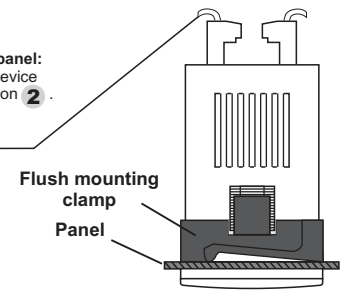

To removing the device from the panel:
- While pressing both side of the device in direction **1** and push it in direction **2**.

Connection Cables
Ambient temperature sensor

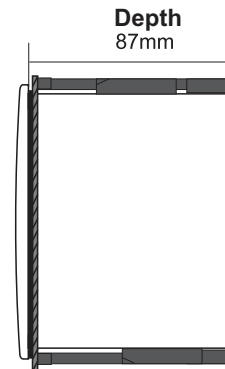
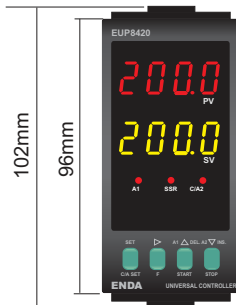
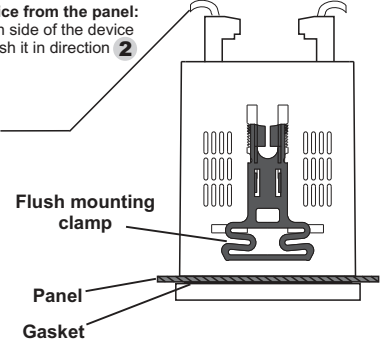

To removing the device from the panel:
- While pressing both side of the device in direction **1** and push it in direction **2**.

Connection Cables
Ambient temperature sensor

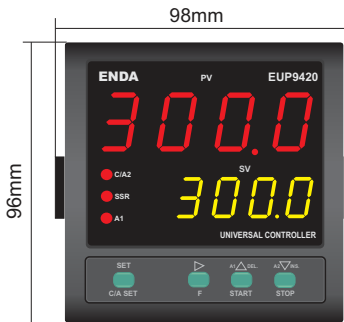
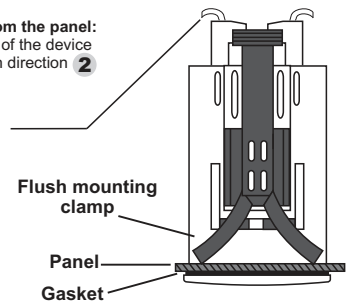

To removing the device from the panel:
- While pressing both side of the device in direction **1** and push it in direction **2**.

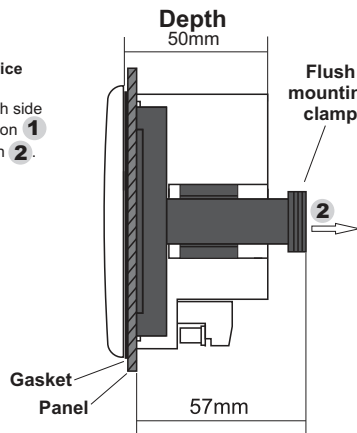

Flush mounting clamp



ENDA EUPx420 Series PID Temperature Controllers are intended for installation in control panels. Make sure that the device is used only for intended purpose. The shielding must be grounded on the instrument side.

During an installation, all of the cables that are connected to the device must be free of energy. The device must be protected against inadmissible humidity, vibrations, severe soiling. Make sure that the operation temperature is not exceeded. All input and output lines that are not connected to the supply network must be laid out as shielded and twisted cables. These cables should not be close to the power cables or components. The installation and electrical connections must be carried on by a qualified staff and must be according to the relevant locally applicable regulations.

PANEL CUT-OUT

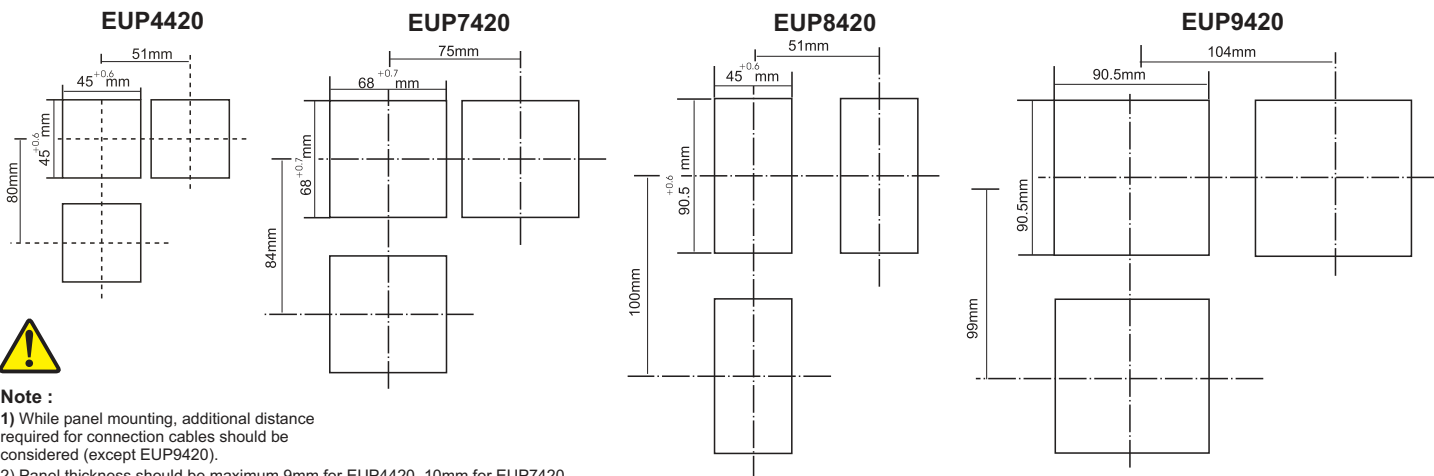

Note :

- 1) While panel mounting, additional distance required for connection cables should be considered (except EUP9420).
- 2) Panel thickness should be maximum 9mm for EUP4420, 10mm for EUP7420, 8mm for EUP8420 and 6mm for EUP9420.
- 3) If there is no free space at back side of the device, it would be difficult to remove it from the panel. Required minimum free spaces ;
EUP4420 = 100mm, EUP7420 = 90mm, EUP8420 = 90mm, EUP9420 = 60mm.

ENDA EUPx420 SERIES PID TEMPERATURE CONTROLLER MODBUS PROTOCOL ADDRESS MAP

1.1 Memory Map for Holding Registers

	Parameter Number	Holding Register Address Decimal (Hex)	Data Type	Data Content	Read / Write Permission	Parameter Name	Default Value
Control Output Parameters	H0	0000d (0000h)	Word	Control output, temperature setpoint value	R/W	C15E	400
	H1	0001d (0001h)	Word	Control output, 2nd temperature setpoint value	R/W	C25E	400
	H2	0002d (0002h)	Word	Control output, minimum setpoint value	R/W	C5Lo	0
	H3	0003d (0003h)	Word	Control output, maximum setpoint value	R/W	C5Hi	600
	H4	0004d (0004h)	Word	Control output, proportional band setpoint value (Adjustable between 0.0% and 100.0%)	R/W	C.Pb	4
	H5	0005d (0005h)	Word	Control output, hysteresis value (Adjustable between 1 and 50 °C or °F)	R/W	CHYS	2
	H6	0006d (0006h)	Word	Control output, integral time (Adjustable between 0.1 and 100.0 minute)	R/W	C.ti	40
	H7	0007d (0007h)	Word	Control output, derivative time (Adjustable between 0.01 and 10.00 minute)	R/W	C.td	100
	H8	0008d (0008h)	Word	Control output, time period setpoint value (Adjustable between 1 and 125 second)	R/W	C.ct	20
	H9	0009d (0009h)	Word	Control output, set value power ratio (Adjustable between 0% and 100%)	R/W	CCPS	0
	H10	0010d (000Ah)	Word	Control output energy percentage in case of sensor error (can be set between 0% to 100%)	R/W	CEPS	0
A1 Output Parameters	H11	0011d (000Bh)	Word	Control output, soft start value	R/W	5555	0
	H12	0012d (000Ch)	Word	Alarm1 output temperature setpoint value	R/W	A15E	500
	H13	0013d (000Dh)	Word	Alarm1 output minimum setpoint value limit	R/W	A15L	0
	H14	0014d (000Eh)	Word	Alarm1 output maximum setpoint value limit	R/W	A15H	600
	H15	0015d (000Fh)	Word	Alarm1 output proportional band set value (Adjustable between 0.0% and 100.0%)	R/W	A1Pb	0
	H16	0016d (0010h)	Word	Alarm1 output hysteresis value (Adjustable between 1 and 50 °C or °F)	R/W	A1HY	2
	H17	0017d (0011h)	Word	Alarm1 output, integral time (Adjustable between 0.1 and 100.0 minute)	R/W	A1ti	0
	H18	0018d (0012h)	Word	Alarm1 output, derivative time (Adjustable between 0.01 and 10.00 minute)	R/W	A1td	0
	H19	0019d (0013h)	Word	Alarm1 output, time period setpoint value (Adjustable between 1 and 125 second)	R/W	A1ct	20
	H20	0020d (0014h)	Word	Alarm1 output, set value power ratio (Adjustable between 0% and 100%)	R/W	A1PS	0
	H21	0021d (0015h)	Word	Alarm1 output, set value power ratio in case of sensor failure (Adjustable between %0 and %100)	R/W	A1EP	0
H22	0022d (0016h)	Word	Alarm1 output type selection (Values can be given from 0 to 4) (0 = Independent alarm, 1 = Deviation alarm, 2 = Band alarm, 3 = Active alarm after in band time, 4 = Alarm1 output, cooling control selection)	R/W	A1tP	0	
A2 Output Parameters	H23	0023d (0017h)	Word	Alarm2 output, temperature setpoint value	R/W	A25E	500
	H24	0024d (0018h)	Word	Alarm2 output minimum setpoint value limit	R/W	A25L	0
	H25	0025d (0019h)	Word	Alarm2 output maximum setpoint value limit	R/W	A25H	600
	H26	0026d (001Ah)	Word	Alarm2 output, hysteresis value (Adjustable between 1 and 50 °C or °F)	R/W	A2HY	2
	H27	0027d (001Bh)	Word	Alarm2 output type selection (Values can be given from 0 to 3) (0 = Independent alarm, 1 = Deviation alarm, 2 = Band alarm, 3 = Active alarm after in band time)	R/W	A2tP	0
Configuration Parameters	H28	0028d (001Ch)	Word	Input selection number (0 = PT100 Decimal, 1 = Pt100 Non-decimal, 2 = J Decimal, 3 = J Non-decimal, 4 = K Decimal, 5 = K Non-decimal, 6 = L Decimal, 7 = L Non-decimal, 8 = T Decimal, 9 = T Non-decimal, 10= S Non-decimal, 11 = R Non-decimal, 12 = 0-20mA, 13 = 4-20mA, 14 = 0-10V, 15 = 2-10V, 16 = 0-25mV, 17 = 0-40mV	R/W	inpE	5
	H29	0029d (001Dh)	Word	ModBus device address (Adjustable between 1 and 247)	R/W	dAdr	1
	H30	0030d (001Eh)	Word	Modbus communication speed (Baudrate) (0 = Modbus cancel, 1 = 2400 bps, 2 = 4800 bps, 3 = 9600 bps, 4 = 19200 bps, 5 = 38400 bps)	R/W	bAud	3
	H31	0031d (001Fh)	Word	Digital filter coefficient (Adjustable between 1 and 200, 1 = filter is disable)	R/W	FLtr	10
	H32	0032d (0020h)	Word	Control output, selection value (0 = C/A2 Control output selection, 1 = SSR/ANL is SSR, 2 = SSR/ANL is 0-20mA, 3 = SSR/ANL is 4-20mA. ATTENTION !! H42 parameter will be 0 if this parameter set to different from 0.	R/W	C.o5E	0
	H33	0033d (0021h)	Word	Analog output minimum out percentage	R/W	RoLo	0
	H34	0034d (0022h)	Word	Analog output maximum out percentage		RoHi	100
	H35	0035d (0023h)	Word	Offset value		oFF5	0
	H36	0036d (0024h)	Word	Function control parameter. (23040d (5A00h) self tune stops when this value is entered) (23041d (5A01h) self tune starts when this value is entered) (23042d (5A02h) returns to factory defaults when this value is entered)		----	0
	H37	0037d (0025h)	Word	Full opening time duration for Motorized Valve. Can be adjusted between 2 and 300 seconds.		R.o.t.	20
	H38	0038d (0026h)	Word	Controlling Period for Motorized Valve. Can be set between 1% to %50 by dependent on H37 parameter.		R.c.ct.	20

ENDA EUPx420 SERIES PID TEMPERATURE CONTROLLER MODBUS PROTOCOL ADDRESS MAP

1.1 Memory Map for Holding Registers (continue)

Configuration Parameters	Parameter Number	Holding Register Address Decimal (Hex)	Data Type	Data Content	Read / Write Permission	Parameter Name	Default Value
	H40	0040d (0028h)	Word	Digital input control parameter (0 = Digital input off, 1 = 2nd set value can be selected by digital input, 2 = Manual mode can be entered via digital input, 3 = Can be switched to display mode via digital input)	R/W	<i>d.inç.</i>	0
	H41	0041d (0029h)	Word	Function key control parameter (0 = Function key off, 1 = 2nd Set value can be selected by function key, 2 = Manual mode can be entered by using function key, 3 = Can be switched to display mode by using function key)	R/W	<i>Ft.Eç.</i>	0
	H42	0042d (002Ah)	Word	Retransmission output control parameter: If this parameter is 0, Retransmission output; off If this parameter is 1, Analog output; 0-20mA Retransmission output If this parameter is 2, Analog output; 4-20mA Retransmission output ATTENTION!! To setting up this parameter, H32 parameter must be set to 0.	R/W	<i>ç.tr.b.</i>	0
	H43	0043d (002Bh)	Word	Retransmission output lower scale value.	R/W	<i>ç.o.l.o.</i>	0
	H44	0044d (002Ch)	Word	Retransmission output upper scale value.	R/W	<i>ç.o.H.ı.</i>	600
	H45	0045d (002Dh)	Word	Decimal Point selection for mA anv V inputs.	R/W	<i>d.P.b.E.</i>	0
	H46	0046d (002Eh)	Word	User defined lower scale value for 0-20mA, 4-20mA, 0-10V and 2-10V input selections	R/W	<i>u.b.l.o.</i>	0
	H47	0047d (002Fh)	Word	User defined upper scale value for 0-20mA, 4-20mA, 0-10V and 2-10V input selections	R/W	<i>u.b.H.ı.</i>	9999
	H48	0048d (0030h)	Word	Control output menu, security parameter (0 = Menu invisible, 1 = Menu programmable, 2 = Menu only visible)	R/W	<i>ç.o.b.c.</i>	1
	H49	0049d (0031h)	Word	Alarm1 output menu security parameter (0 = Menu invisible, 1 = Menu programmable, 2 = Menu only visible)	R/W	<i>A.ı.b.c.</i>	1
	H50	0050d (0032h)	Word	Alarm2 output menu, security parameter (0 = Menu invisible, 1 = Menu programmable, 2 = Menu only visible)	R/W	<i>A.2.b.c.</i>	1
	H51	0051d (0033h)	Word	Configuration menu, security parameter (0 = Menu invisible, 1 = Menu programmable, 2 = Menu only visible)	R/W	<i>ç.o.b.c.</i>	1
H52	0052d (0034h)	Word	Self tune menu, security parameter (0 = Menu invisible, 1 = Self tune can be done)	R/W	<i>b.t.b.c.</i>	1	
H53	0053d (0035h)	Word	Profile configuration menu, security parameter (0 = Menu invisible, 1 = Menu programmable, 2 = Menu only visible)	R/W	<i>P.ç.b.c.</i>	1	

1.2 Memory Map for Coils

Parameter Number	Coil Address	Data Type	Parameter Description	Read / Write Permission	Parameter Name	Default Value
C0	(0000)h	Bit	Alarm2 condition (0 = Active Low ,1 =Active High)	R/W	<i>A.2.b.t.</i>	1
C1	(0001)h	Bit	Alarm2 condition selection on probe failure (0 = Off , 1 = On)	R/W	<i>A.2.E.r.</i>	0
C2	(0002)h	Bit	Alarm1 condition (0 = Active Low ,1 =Active High)	R/W	<i>A.ı.b.t.</i>	1
C3	(0003)h	Bit	Alarm1 condition selection on probe failure (0 = Off , 1 = On)	R/W	<i>A.ı.E.r.</i>	0
C4	(0004)h	Bit	Control output configuration (0 = Heat ; 1 = Cool)	R/W	<i>ç.t.Y.P.</i>	0
C5	(0005)h	Bit	Temperature unit (0 = °C ; 1 = °F)	R/W	<i>u.n.ı.t.</i>	0
C6	(0006)h	Bit	Control outputs active (0 = Control outputs active, 1 = Only display mode)	R/W	<i>----</i>	0
C7	(0007)h	Bit	Controlling according to 2nd temperature setpoint (If C7 = 0 is H0, if C7 = 1 is H1)	R/W	<i>----</i>	0
C8	(0008)h	Bit	Auto/Manual selection (0 = Automatic "Running mode", 1 = Manual "Running mode". In this mode, output generated according to H39 parameter.)	R/W	<i>----</i>	0
C9	(0009)h	Bit	Control format in case of probe failure (0 = H10 proportional control according to percentage value, 1 = Error found before the setpoint control is done with the value of the proportional control)	R/W	<i>ç.E.c.t.</i>	0

1.3 Memory Map for Input Registers

Parameter Number	Input Register Address Decimal (Hex)	Data Type	Parameter Description	Read / Write Permission
I0	0000d (0000h)	Word	Measured temperature	R
I1	0001d (0001h)	Word	Analog output percentage	R
I2	0002d (0002h)	Word	Measurement error codes 0 = No error, 1 = Sensor short circuit, 2 = Lower scale error, 3 = Upper scale error, 4 = Sensor connection lost, 5 = Wrong input selection.	R
I3	0003d (0003h)	Word	Self tune condition codes 0 = No error, 1 = Initial temperature is higher than 60% setpoint value, 2 = Calculating PID parameters, 3 = Calculating power set parameters	R
I4	0004d (0004h)	Word	Current (active) temperature setpoint.	R
I5	0005d (0005h)	Word	Reserved	R
I6	0006d (0006h)	Word	Current (active) decimal point value (0 = No decimal point, 1 = 0.0 Decimal point is tenths)	R

1.4 Memory Map for Discrete input

Parameter Number	Discrete Input Address	Data Type	Parameter Description	Read / Write Permission
D0	(0000)h	Bit	C/A2 Control output status (0 = OFF ,1 = ON)	R
D1	(0001)h	Bit	A1 Output status (0 = OFF , 1 = ON)	R
D2	(0002)h	Bit	SSR Output status (0 = OFF ,1 = ON)	R
D3	(0003)h	Bit	Digital input status (0 = OFF ,1 = ON)	R

ENDA EUPx420 SERIES PID TEMPERATURE CONTROLLER MODBUS PROTOCOL ADDRESS MAP

2.1 Memory Map for Profile Control Holding Registers

Parameter Number	Holding Register Address Decimal (Hex)	Data Type	Data Content	Read / Write Permission	Parameter Name	Default Value																																
PH0	0100d (0064h)	Word	Profile time base set value. (0 = 0000s, 1 = 00m59s, 2 = 0000m, 3 = 99m59s)	R/W	ت.ب.ز.ب.	0																																
PH1	0101d (0065h)	Word	Maximum number of steps (can be adjusted between 0 and 16. If set to 0, runs on timer/thermostat mode)	R/W	ب.ن.و.ن.	0																																
PH2	0102d (0066h)	Word	Target temperature difference for increasing the step. (It can be set between 0 and H3 parameter. If the step time is reached before the target temperature is reached when the profile is checked, then the difference between the target temperature and the measured temperature is expected to be less than or equal to this parameter value and then proceed to the next step. If the difference is smaller than or equal to this parameter, the timer is switched on. See Drawing-4 / page 4 on user manual).	R/W	ب.ع. ا.ب.	0																																
PH38	0138d (008Ah)	Word	Display selection parameter: It can take between 1 and 10 values. When 1 is selected, only the process value is displayed. When 2 and up values are selected, the step number and the process value are displayed alternately if 2 or more step profiles are programmed. The entered number indicates the number of seconds to display the step number. For example, if 4 is entered, the step number is displayed for 1 second in 4 seconds.	R/W	د.ب.ع.ل.	0																																
PH3	0103d (0067h)	Word	1st-Step target temperature set value (can be adjusted between H2 and H3 parameter) If PH1 parameter set 0, temperature setpoint for Timer/Thermostat mode.	R/W	ت.ع.01 ل.ب.ع.ت	200																																
PH4	0104d (0068h)	Word	1st-Time value can be set from 0 to 9999 seconds or minutes (changes with the depending on PH0 parameter). If PH1 parameter set 0, time setpoint for Timer/Thermostat mode.	R/W	ت.ا.01 ت.ا.ن.ع	60																																
PH5	0105d (0069h)	Word	2nd-Step target temperature set value (can be adjusted between H2 and H3 parameter)	R/W	ت.ع.02	200																																
PH6	0106d (006Ah)	Word	2nd-Time value can be set from 0 to 9999 seconds or minutes (changes with the depending on PH0 parameter).	R/W	ت.ا.02	60																																
PH7	0107d (006Bh)	Word	3rd-Step target temperature set value (can be adjusted between H2 and H3 parameter)	R/W	ت.ع.03	200																																
PH8	0108d (006Ch)	Word	3rd-Time value can be set from 0 to 9999 seconds or minutes (changes with the depending on PH0 parameter).	R/W	ت.ا.03	60																																
PH9	0109d (006Dh)	Word	4th-Step target temperature set value (can be adjusted between H2 and H3 parameter)	R/W	ت.ع.04	200																																
PH10	0110d (006Eh)	Word	4th-Time value can be set from 0 to 9999 seconds or minutes (changes with the depending on PH0 parameter).	R/W	ت.ا.04	60																																
PH11	0111d (006Fh)	Word	5th-Step target temperature set value (can be adjusted between H2 and H3 parameter)	R/W	ت.ع.05	200																																
PH12	0112d (0070h)	Word	5th-Time value can be set from 0 to 9999 seconds or minutes (changes with the depending on PH0 parameter).	R/W	ت.ا.05	60																																
PH13	0113d (0071h)	Word	6th-Step target temperature set value (can be adjusted between H2 and H3 parameter)	R/W	ت.ع.06	200																																
PH14	0114d (0072h)	Word	6th-Time value can be set from 0 to 9999 seconds or minutes (changes with the depending on PH0 parameter).	R/W	ت.ا.06	60																																
PH15	0115d (0073h)	Word	7th-Step target temperature set value (can be adjusted between H2 and H3 parameter)	R/W	ت.ع.07	200																																
PH16	0116d (0074h)	Word	7th-Time value can be set from 0 to 9999 seconds or minutes (changes with the depending on PH0 parameter).	R/W	ت.ا.07	60																																
PH17	0117d (0075h)	Word	8th-Step target temperature set value (can be adjusted between H2 and H3 parameter)	R/W	ت.ع.08	200																																
PH18	0118d (0076h)	Word	8th-Time value can be set from 0 to 9999 seconds or minutes (changes with the depending on PH0 parameter).	R/W	ت.ا.08	60																																
PH19	0119d (0077h)	Word	9th-Step target temperature set value (can be adjusted between H2 and H3 parameter)	R/W	ت.ع.09	200																																
PH20	0120d (0078h)	Word	9th-Time value can be set from 0 to 9999 seconds or minutes (changes with the depending on PH0 parameter).	R/W	ت.ا.09	60																																
PH21	0121d (0079h)	Word	10th-Step target temperature set value (can be adjusted between H2 and H3 parameter)	R/W	ت.ع.10	200																																
PH22	0122d (007Ah)	Word	10th-Time value can be set from 0 to 9999 seconds or minutes (changes with the depending on PH0 parameter).	R/W	ت.ا.10	60																																
PH23	0123d (007Bh)	Word	11th-Step target temperature set value (can be adjusted between H2 and H3 parameter)	R/W	ت.ع.11	200																																
PH24	0124d (007Ch)	Word	11th-Time value can be set from 0 to 9999 seconds or minutes (changes with the depending on PH0 parameter).	R/W	ت.ا.11	60																																
PH25	0125d (007Dh)	Word	12th-Step target temperature set value (can be adjusted between H2 and H3 parameter)	R/W	ت.ع.12	200																																
PH26	0126d (007Eh)	Word	12th-Time value can be set from 0 to 9999 seconds or minutes (changes with the depending on PH0 parameter).	R/W	ت.ا.12	60																																
PH27	0127d (007Fh)	Word	13th-Step target temperature set value (can be adjusted between H2 and H3 parameter)	R/W	ت.ع.13	200																																
PH28	0128d (0080h)	Word	13th-Time value can be set from 0 to 9999 seconds or minutes (changes with the depending on PH0 parameter).	R/W	ت.ا.13	60																																
PH29	0129d (0081h)	Word	14th-Step target temperature set value (can be adjusted between H2 and H3 parameter)	R/W	ت.ع.14	200																																
PH30	0130d (0082h)	Word	14th-Time value can be set from 0 to 9999 seconds or minutes (changes with the depending on PH0 parameter).	R/W	ت.ا.14	60																																
PH31	0131d (0083h)	Word	15th-Step target temperature set value (can be adjusted between H2 and H3 parameter)	R/W	ت.ع.15	200																																
PH32	0132d (0084h)	Word	15th-Time value can be set from 0 to 9999 seconds or minutes (changes with the depending on PH0 parameter).	R/W	ت.ا.15	60																																
PH33	0133d (0085h)	Word	16th-Step target temperature set value (can be adjusted between H2 and H3 parameter)	R/W	ت.ع.16	200																																
PH34	0134d (0086h)	Word	16th-Time value can be set from 0 to 9999 seconds or minutes (changes with the depending on PH0 parameter).	R/W	ت.ا.16	60																																
PH35	0135d (0087h)	Word	A1 Output control bits in steps. <table border="1" style="width: 100%; text-align: center;"> <tr> <td>B15</td><td>B14</td><td>B13</td><td>B12</td><td>B11</td><td>B10</td><td>B9</td><td>B8</td><td>B7</td><td>B6</td><td>B5</td><td>B4</td><td>B3</td><td>B2</td><td>B1</td><td>B0</td> </tr> <tr> <td>Step8</td><td>Step7</td><td>Step6</td><td>Step5</td><td>Step4</td><td>Step3</td><td>Step2</td><td>Step1</td><td>Step16</td><td>Step15</td><td>Step14</td><td>Step13</td><td>Step12</td><td>Step11</td><td>Step10</td><td>Step9</td> </tr> </table> AL1 Output will be activated when related step bits are set.	B15	B14	B13	B12	B11	B10	B9	B8	B7	B6	B5	B4	B3	B2	B1	B0	Step8	Step7	Step6	Step5	Step4	Step3	Step2	Step1	Step16	Step15	Step14	Step13	Step12	Step11	Step10	Step9	R/W	----	0
B15	B14	B13	B12	B11	B10	B9	B8	B7	B6	B5	B4	B3	B2	B1	B0																							
Step8	Step7	Step6	Step5	Step4	Step3	Step2	Step1	Step16	Step15	Step14	Step13	Step12	Step11	Step10	Step9																							
PH36	0136d (0088h)	Word	A2 output control step bits. (Set such as PH35 parameter).	R/W	----	0																																
PH37	0137d (0089h)	Word	Step control parameter (holding registers of PC32-PC38 step control coils) <table border="1" style="width: 100%; text-align: center;"> <tr> <td>B15</td><td>B14</td><td>B13</td><td>B12</td><td>B11</td><td>B10</td><td>B9</td><td>B8</td><td>B7</td><td>B6</td><td>B5</td><td>B4</td><td>B3</td><td>B2</td><td>B1</td><td>B0</td> </tr> <tr> <td>—</td><td>PC38</td><td>PC37</td><td>PC36</td><td>PC35</td><td>PC34</td><td>PC33</td><td>PC32</td><td>—</td><td>—</td><td>—</td><td>—</td><td>—</td><td>—</td><td>—</td><td>—</td> </tr> </table> See chapter 2.2 coil descriptions for bit significations.	B15	B14	B13	B12	B11	B10	B9	B8	B7	B6	B5	B4	B3	B2	B1	B0	—	PC38	PC37	PC36	PC35	PC34	PC33	PC32	—	—	—	—	—	—	—	—	R/W	----	0
B15	B14	B13	B12	B11	B10	B9	B8	B7	B6	B5	B4	B3	B2	B1	B0																							
—	PC38	PC37	PC36	PC35	PC34	PC33	PC32	—	—	—	—	—	—	—	—																							

Step Control Parameters

ENDA EUPx420 SERIES PID TEMPERATURE CONTROLLER MODBUS PROTOCOL ADDRESS MAP

2.2 Memory Map for Step Control Bits

Parameter Number	Coil Address	Data Type	Data Content	Read / Write Permission	Parameter Name	Default Value
PC0-PC15	0100d (0064h) 0115d (0073h)	Bit	A1 alarm output programming coils in profile steps ; If PC0=1, A1 output is ON at 1st step.... If PC15=1, A1 output will be ON at 16th step.	R/W		0
PC16-PC31	0116d (0074h) 0131d (0083h)	Bit	C/A2 alarm output programming coils in profile steps ; If PC16=1, C/A2 output is ON at 1st step.... If PC31=1, C/A2 output will be ON at 16th step.	R/W		0
PC32	0132d (0084h)	Bit	Depending on set control or profile control selection. (PC32=0 thermostat mode, PC32=1 profile control mode)	R/W	<i>PCon</i>	0
PC33	0133d (0085h)	Bit	If PC33 = 0, in profile mode, the profile is stopped and the first step is returned. If PC33 = 1, the profile is started in profile mode.	R/W		0
PC34	0134d (0086h)	Bit	If PC34 = 0, the profile continues to run. If PC34 = 1, the profile operation is put on hold (Hold mode).	R/W		0
PC35	0135d (0087h)	Bit	If PC35 = 0, the control process is finished when the profile is finished (Control outputs are OFF). If PC35 = 1, the control is continued according to the last set value when the profile is finished.	R/W	<i>CCon</i>	0
PC36	0136d (0088h)	Bit	If PC36 = 0, the profile stops and returns to 1st step if power-off. If PC36 = 1, In case of power-off or restarted and the current step value of the temperature setpoint(s) are not configured for resuming, returns to the 1st step and the profile stops.	R/W	<i>PonT</i>	0
PC37	0137d (0089h)	Bit	If PC37 = 0, output A1 is controlled according to H22 parameter. If PC37 = 1 and PC32 = 1, output A1 is controlled at each step according to PH35 parameter.	R/W	<i>RI.Pc</i>	0
PC38	0138d (008Ah)	Bit	If PC38 = 0, output A2 is controlled according to H27 parameter. If PC38 = 1 and PC32 = 1, output C / A2 is controlled at each step according to PH36 parameter.	R/W	<i>RA.Pc</i>	0

2.3 Memory Map for Step Control Input Registers

Parameter Number	Input Register Address Desimal (Hex)	Data Type	Parameter Description	Read / Write Permission
PI0	0100d (0064h)	Word	The number of the active step.	R
PI1	0101d (0065h)	Word	Remaining time indicator of the active step.	R
PI2	0102d (0066h)	Word	Target temperature value of the active step.	R

2.4 Memory Map for Step Control Status Indicator Bits

Parameter Number	Discrete Input Address	Data Type	Parameter Description	Read / Write Permission
PD0	0100d (0064h)	Bit	If PD0=1, profile is in constant temperature step.	R
PD1	0101d (0065h)	Bit	If PD1=1, profile is in heating step.	R
PD2	0102d (0066h)	Bit	If PD2=1, profile is in cooling step.	R
PD3	0103d (0067h)	Bit	If PD3=1, profile terminated..	R
PD4	0104d (0068h)	Bit	If PD4=1, profile step timer is 0.	R
PD5	0105d (0069h)	Bit	PD5=1, profile step timer is running.	R

3.1 Memory Map for Software Revision Input Registers

Software Revision	61472d (F020h)	14 Word	Software name and update is read in ASCII format and as 14 word. For example : EU4420-01 03 Feb 2016. Memory Formats : <div style="text-align: center;"> <p>Word₁ Word₂ Word₃ Word₄ Word₅ Word₆ Word₇ Word₈ Word₉ Word₁₀ Word₁₁ Word₁₂ Word₁₃ Word₁₄</p> <p>U E 4 4 0 2 0 - 1 3 0 F b e 2 1 0 . 6</p> </div>	R
NOTE : To view each word correctly by changing the byte sequences should be displayed as ASCII TEXT				

ENDA EUPx420 SERIES PID TEMPERATURE CONTROLLER MODBUS PROTOCOL ADDRESS MAP

4. MODBUS ERROR MESSAGES

Modbus protocol has two types error, communication error and operating error. Reason of the communication error is data corruption in transmission. Parity and CRC control should be done to prevent communication error. Receiver side checks parity and CRC of the data. If they are wrong, the message will be ignored. If format of the data is true but function doesn't perform for any reason, operating error occurs. Slave realizes error and sends error message. Most significant bit of function is changed '1' to indicate error in error message by slave. Error code is sent in data section. Master realizes error type via this message.

ModBus Error Codes

Error Code	Name	Meaning
01	ILLEGAL FUNCTION	The function code received in the query is not an allowable action for the slave. If a Poll Program Complete command was issued, this code indicates that no program function preceded it.
02	ILLEGAL DATA ADDRESS	The data address received in the query is not an allowable address for the slave.
03	ILLEGAL DATA VALUE	A value contained in the query data field is not an allowable value for the slave.

Message sample :

Structure of command message (Byte Format)

Device Address		(0A)h
Function Code		(01)h
Beginning address of coils.	MSB	(04)h
	LSB	(A1)h
Number of coils (N)	MSB	(00)h
	LSB	(01)h
CRC DATA	LSB	(AC)h
	MSB	(63)h

Structure of response message (Byte Format)

Device Address		(0A)h
Function Code		(81)h
Error Code		(02)h
CRC DATA	LSB	(B0)h
	MSB	(53)h

As you see in command message, coil information of (4A1)h = 1185 is required but there isn't any coil with 1185 address. Therefore error code with number (02) (Illegal Data Address) sends.

