



Read this document carefully before using this device. The guarantee will be expired by device damages if you don't attend to the directions in the user manual. Also we don't accept any compensations for personal injury, material damage or capital disadvantages.

ENDA EUC9526 Series Universal Control Device

Thank you for choosing EUC9526 series universal control device.

- ▶ 96x96mm sized.
- ▶ 3,5 inches TFT, graphic and 5 digit display.
- ▶ 2 sensor inputs selectable as TC, RTD, NTC, R, mA, V or mV.
- ▶ Input offset feature.
- ▶ 32 point linearization for analog inputs.
- ▶ Selectable relay, SSR or analog outputs.
- ▶ Selectable, input proportional transmitter output(mA or V).
- ▶ 50ms sampling time.
- ▶ PID control.
- ▶ PID selftune.
- ▶ PID auto-tune.
- ▶ **Selftune automatic PID calculation or manually enter PID parameters if known.**
- ▶ Soft-Star feature.
- ▶ 24Vdc for sensor supply.
- ▶ In case of sensor failure, manually, periodical or auto-periodical control can be selected.
- ▶ Security levels for menu and configuration page.
- ▶ Programming with Key Pad and ModBus.
- ▶ Rs485 ModBus protocol communication feature (optional).
- ▶ CE marked according to European Norms.

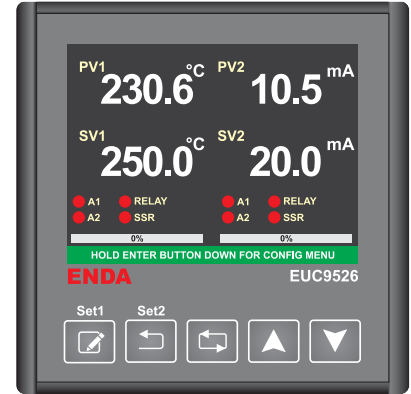

RoHS Compliant

Analog Inputs							
Input Type	Range	Accuracy	Input Resist.	Cable Color	Standart		
TC	B (Pt130Rh-Pt6Rh)	200,0 ... 1800,0°C 392,0 ... 3272,0°F	% ±0.1 and ±2°C (3.6°F)	Ri > 100kΩ	+ undefined - white	EN 60584	
	E (NiCr-Con)	-100,0 900,0°C -148,0 ... 1652,0°F	% ±0.1 and ±0,5°C (1°F)		+ purple - white		
	J (Fe-Con)	-100,0 900,0°C -148,0 ... 1652,0°F	% ±0.1 and ±0,5°C (1°F)		+ black - white		
	K (NiCr-Ni)	-100,0 ... 1300,0°C -148,0 ... 2372,0°F	% ±0.1 and ±0,5°C (1°F)		+ green - white		
	L (Fe-Con)	-100,0 900,0°C -148,0 ... 1652,0°F	% ±0.1 and ±1,5°C (2,7°F)		+ red - blue	DIN43710	
	N (NiCrSi-NiSi)	-200,0 ... 1300,0°C -328,0 ... 2372,0°F	% ±0.1 and ±0,5°C (1°F)		+ lilac - white	EN 60584	
	R (Pt13Rh-Pt)	0,0 ... 1700,0°C 32,0 ... 3092,0°F	% ±0.1 and ±1°C (1,8°F)		+ orange - white		
	S (Pt10Rh-Pt)	0,0 ... 1700,0°C 32,0 ... 3092,0°F	% ±0.1 and ±1°C (1,8°F)		+ orange - white		
	T (Cu-Con)	-250,0 300,0°C -418,0 572,0°F	% ±0.1 and ±0,5°C (1°F)		+ brown - white		
RTD	Pt100	-200,0 850,0°C -328,0 ... 1562,0°F -100,00 ... 160,00°C -148,00 .. 320,00°F	% ±0.1 and ±0,5°C (1°F)	Ri > 100kΩ	Sensor current 250µA	EN 60751	
	NTC	NTC	-60,0 150,0°C -76,0 302,0°F	% ±0.1 and ±0,5°C (1°F)	Ri > 100kΩ		
mA	0 - 20mA	-32768 ... 32767	% ±0.1 and ±1 digit	Ri = 50Ω			
mV	0 - 150mV		% ±0.1 and ±20µV	Ri > 100kΩ			
V	0 - 5V		-327,68 ... 327,67	% ±0.1 and ±1 digit	Ri > 100kΩ		
	1 - 5V						
	0 - 10V						
Ω	0 - 550Ω 0 - 10kΩ		% ±0.2 and ±0.1Ω % ±0,5 and ±10Ω	Ri > 100kΩ	Sensor current 250µA		

OUTPUTS	
Control / Alarm 3	250V AC, 2A , Selectable as NO+NC, 10.000.000 switch without load and 200.000 switch under 250V AC 2A(resistive load)
Alarm 1	250V AC, 2A , Selectable as NO+NC, 10.000.000 switch without load and 200.000 switch under 250V AC 2A(resistive load)
Alarm 2	250V AC, 2A , Selectable as NO, 10.000.000 switch without load and 200.000 switch under 250V AC 2A(resistive load)
SSR	Max. 40 mA , 0 - 12Volt , short-circuit protection.
mA	0 - 20mA or 4 - 20mA , %±0,5 (Max. load resistance is 750Ω.)
V	Max. 30mA , 0 - 10Volt , %±0,5 (short-circuit protection.)

⚠ Specifications are same for both 1.group and 2.group outputs.

ELECTRICAL CHARACTERISTICS	
Supply	90-250V AC, 50/60Hz
Power consumption	Max. 12VA
Wiring	2.5mm² screw-terminal
EMC	EN 61326-1: 2013
Safety requirements	EN 61010-1: 2010 (Pollution degree 2 , overvoltage category II)

ENVIRONMENTAL CONDITIONS	
Ambient/storage temp.	0 ... +50°C/-25 ... 70°C
Max.Relative humidity	Relative humidity 80% for temperatures up to 31°C decreasing linearly to 50% relative humidity at 40°C.
Rated pollution degree	According to EN 60529 Front panel : IP65 , Rear panel : IP20
Height	Max. 2000m

⚠ Do not use the device in locations subject to corrosive and flammable gases.

HOUSING	
Housing type	Suitable for flush-panel mounting.
Dimensions	G96xY96xD81mm
Weight	Approx. 400g.
Enclosure material	Self extinguishing plastics.

⚠ While cleaning the device , solvents(thinner,gasoline,acid etc.) or corrosive materials must not be used.



SISEL MÜHENDİSLİK ELEKTRONİK SAN. VE TİC. A.Ş.
Şerifali Mah. Barbaros Cad. No:18 Y.Dudullu 34775
ÜMRANİYE/İSTANBUL-TÜRKİYE
Tel : +90 216 499 46 64 Pbx. Fax : +90 216 365 74 01
url : www.enda.com.tr



DIMENSIONS

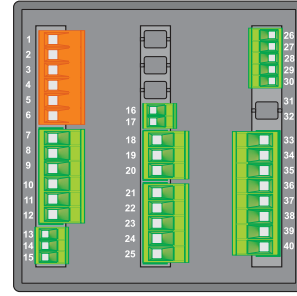
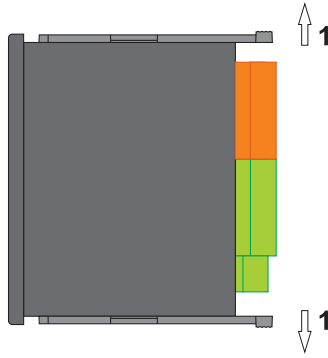
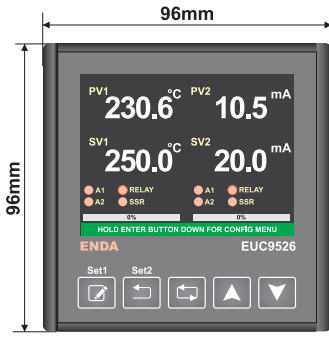

PANEL CUT-OUT

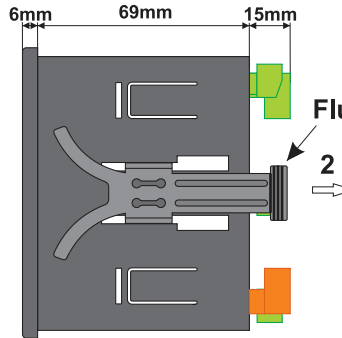
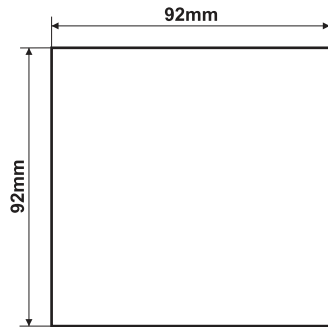

Flush mounting clamp

For removing the device from panel :
 - While pressing both flush mounting clamps of the device in direction 1, pull it in direction 2.

- Not :
- 1) Panel thickness should be maximum 7mm.
 - 2) If there is no 60 mm free space at the back side of the device, it would be difficult to remove it from panel.

CONNECTION DIAGRAM



ENDA EUC9526 is intended for installation in control panels. Make sure that the device is used only for intended purpose. The electrical connections must be carried out by a qualified staff and must be according to the relevant locally applicable regulations. During an installation, all of the cables that are connected to the device must be free of electrical power. The device must be protected against inadmissible humidity, vibrations, severe soiling and make sure that the operation temperature is not exceed. The cables should not be close to the power cables or components.

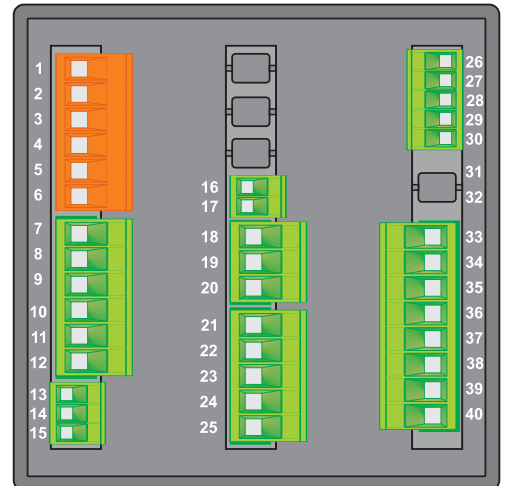
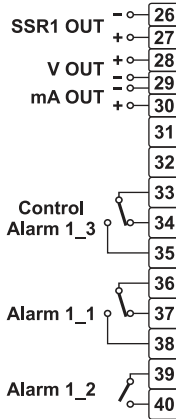
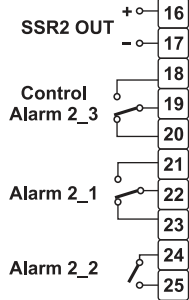
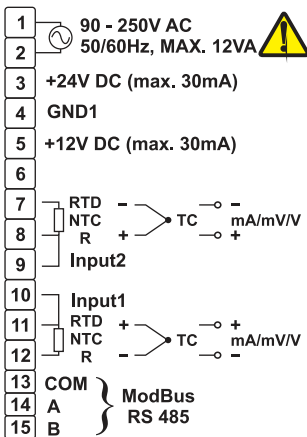

SUPPLY VOLTAGE

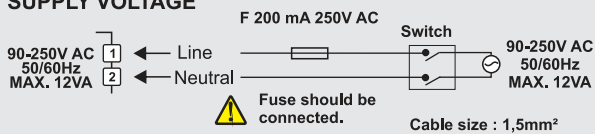

Logic output of the instrument is not electrically insulated from the internal circuits. Therefore, when using grounding thermocouple, do not connect the logic output terminals to the ground.





- Not :
- 1) Main supply cords shall meet the requirements of IEC 60227 or IEC60245.
 - 2) In accordance with safety regulations, the power supply switch shall bring the identification of the relevant instrument and it should be easily accessible by the operator.

10-11-12 inputs for 1. Analog Input, 7-8-9 inputs for 2. Analog Input

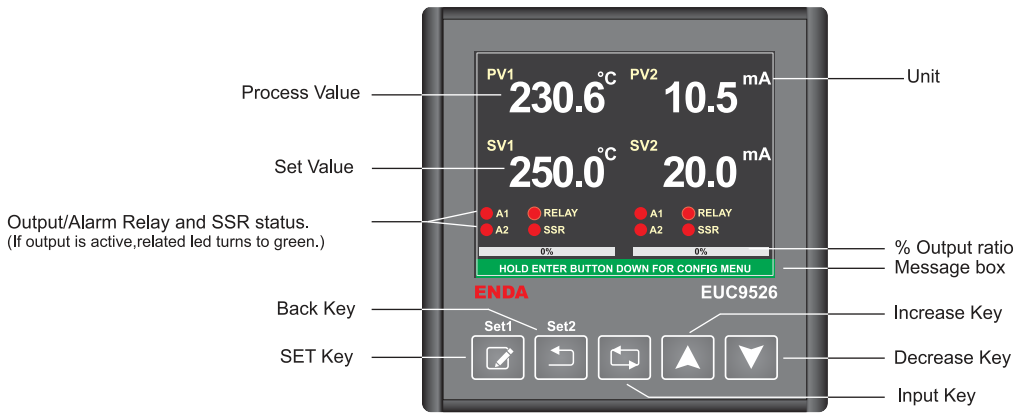

HOME SCREEN



-  **SET Key :** Select/Unselect parameter for increase/decrease parameter value in "Programming Mode". Change SV1 in "Control Mode".
-  **Back Key :** Return previous page in "Programming Mode", Change SV2 in "Control Mode".
-  **Enter Key :** Enter main menu and open sub pages and transition between sub pages in "Programming Mode".
-  **Increase Key :** Transition between parameters (when parameter background is red) and increase selected parameter value (when parameter background is green) in "Programming Mode".
-  **Decrease Key :** Transition between parameters (when parameter background is red) and decrease selected parameter value (when parameter background is green) in "Programming Mode".

 **NOTE :** If Increase Key is held down while the device is powered up , factory parameters will be restored.

Adjusting Device Set Values

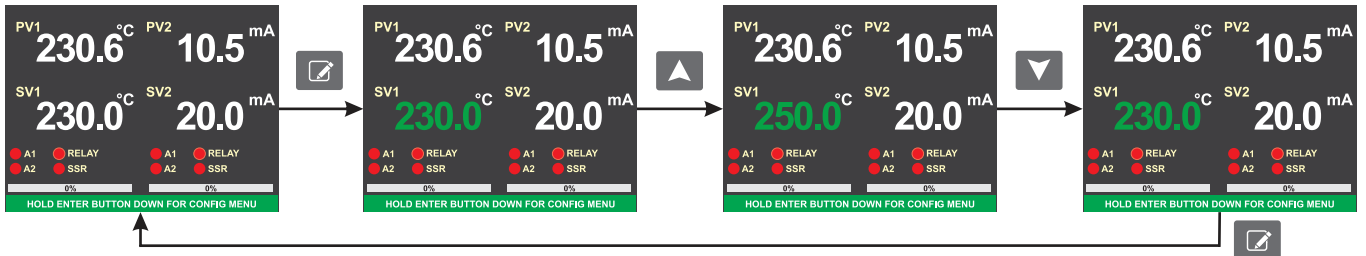

If Set Key pressed once , SV1 's color will be green. In this case SV1 is adjusted by pressing Increase/Decrease keys.
If Set Key pressed again or by waiting 3 seconds , SV1 's color will be white on home screen.

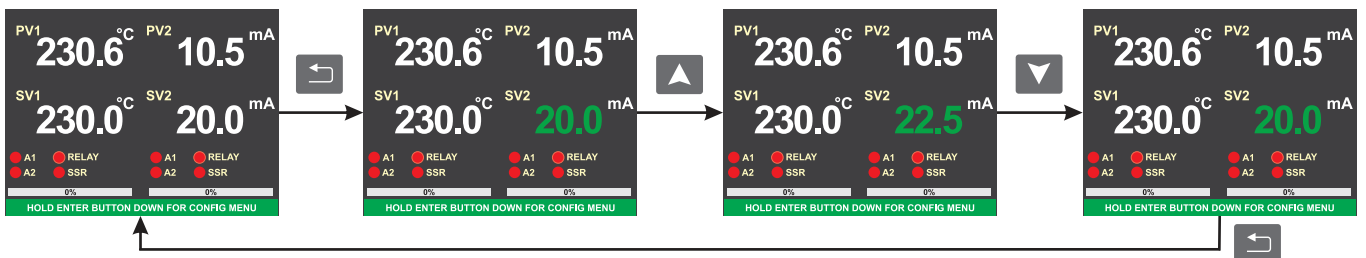

If Back Key pressed once , SV2 's color will be green. In this case SV2 is adjusted by pressing Increase/Decrease keys.
If Back Key pressed again or by waiting 3 seconds , SV2 's color will be white on home screen.

Home Screen

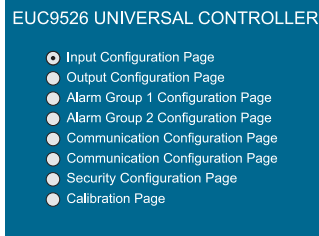
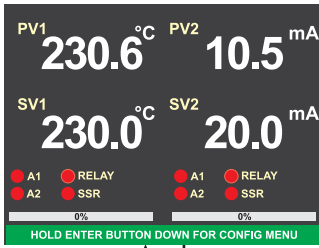

Main menu is opened and "Programming Mode" is started by pressing Enter Key for 2 seconds.

Desired sub menu is selected by pressing Increase/Decrease Keys.

Selected sub menu is opened by pressing Enter Key. Selected sub menu can be opened if permission is given from "Security Configuration Page".

If back Key is pressed or by waiting 10 seconds, parameters will be saved and device turns back to home screen.

NOTE 1 : If power failure occurs while device is programming, parameters wont be saved.

Programming Inputs (Input Configuration Page)

Desired parameter is selected by pressing Increase/Decrease Keys. Background of selected parameter turns red.

If SET Key is pressed, background of selected parameter turns to green and selected parameter can be adjusted to desired value.

If SET Key is pressed again, background of selected parameter turns to red and exits from parameter adjustment.

If Back Key is pressed or by waiting 10 seconds, Input Configuration Page is closed and device turns back to main menu.

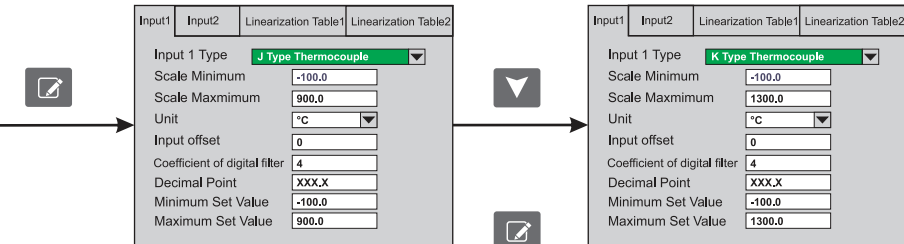
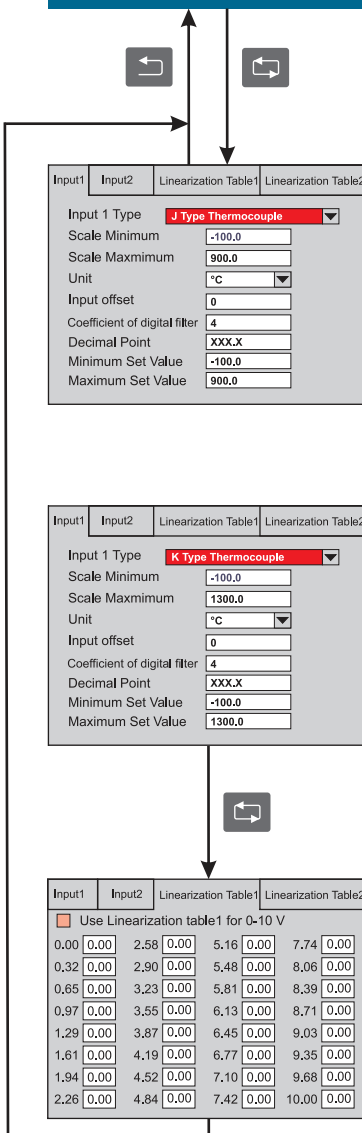

Input 1 Type :
B, E, J, K, L, N, R, S, T, U, Pt100, NTC, 0-20mA, 4-20mA, 0-5V, 1-5V, 0-10V, 0-150mV, 0-550Ω, 0-10kΩ

Scale (Scale Min./Max.) :
Adjustable between -32768 ... 32767.
(Just for mA, V, mV, Ω, kΩ)

Minimum Set Value :
Adjustable between Scale Minimum and Maximum Set Value.

Linearization Table Conf :

If input type is selected as mA, V, mV, Ω or kΩ linearization can be done at 32 points.

Use Linearization Table for 0-10 V can be activated by pressing keys respectively.

Corresponding values of input signals must be entered to table in order to linearize at 32 points.

Maximum Set Value :
Adjustable between Scale Maximum and Minimum Set Value.

Unit :
°C, °F, bar, %RH, Hz, mA, A, mV, V, Ohm, kOhm, %, g, kg, cm, m, m/s, m/min, km/h, cm3/s, m3/h, l/s, l/min, l/h
(Just for mA, V, mV, Ω, kΩ)

Input offset :
Adjustable between -99 ... 99.

Coefficient of digital filter :
1=200ms and it is device sampling time Adjustable between 1... 32. Value of parameter should be increased in interference.

Decimal Point :
According to range table, 1,2 and 3 digit can be selected.

Input1	Input2	Linearization Table1	Linearization Table2
<input checked="" type="checkbox"/> Use Linearization table1 for 0-10 V			
0.00	0.00	2.58	0.00
0.32	0.00	2.90	0.00
0.65	0.00	3.23	0.00
0.97	0.00	3.55	0.00
1.29	0.00	3.87	0.00
1.61	0.00	4.19	0.00
1.94	0.00	4.52	0.00
2.26	0.00	4.84	0.00
5.16	0.00	5.16	0.00
5.48	0.00	5.48	0.00
5.81	0.00	5.81	0.00
6.13	0.00	6.13	0.00
6.45	0.00	6.45	0.00
6.77	0.00	6.77	0.00
7.10	0.00	7.10	0.00
7.42	0.00	7.42	0.00
7.74	0.00	7.74	0.00
8.06	0.00	8.06	0.00
8.39	0.00	8.39	0.00
8.71	0.00	8.71	0.00
9.03	0.00	9.03	0.00
9.35	0.00	9.35	0.00
9.68	0.00	9.68	0.00
10.00	0.00	10.00	0.00

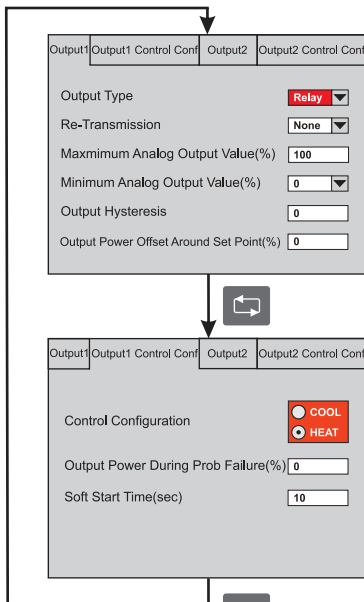

Programming Outputs(Output Configuration Page)

Output Type : Relay, SSR, 0-20mA, 4-20mA or 0-10V. If relay is not selected for output type , relay can be configured as Alarm3.

Re-Transmission : If output is selected as relay or SSR , re-transmission can be selected as 0/4-20mA or 0-10V. If output type is selected as a 0/4-20mA , re-transmission can be selected as a 0-10V. If output type is selected as a 0-10V , re-transmission can be selected as a 0/4-20mA.

Maximum Analog Output Value : % maximum analog output value.

Minimum Analog Output Value : % minimum analog output value.

Output Hysteresis : Adjustable between 0 ... 50 (If Proportional Band is selected 0.0 , ON-OFF control and output hysteresis will be active.)

Output Power Offset Around Set Point : Output power offset around SV according to error. In order to reach SV fast.
 $TotalOutput(\%) = system\ output(\%) + (100 / Proportional\ Band) * error * OutputPowerOffset / 100.$

Control Configuration : Selectable as Cool/Heat control. The cooling control is only ON-OFF control (For Cooling control. Proportional Band must be 0.0).

Output Power During Prob Failure(%): Adjustable between %0...%100. Output will continue in case of prob failure.

Soft Start Time(sec): Adjustable between 0 ... 200 seconds.

Device starts to control according to soft start time after device is powered on.

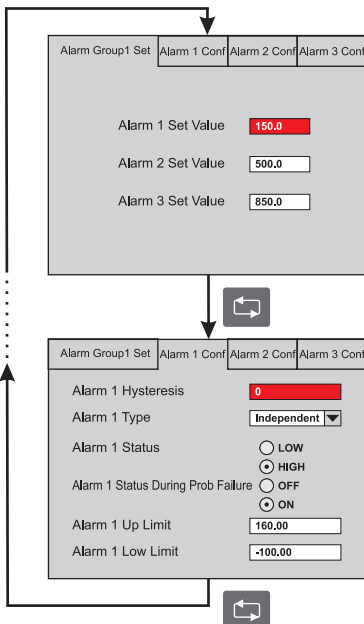

Programming Alarms (Alarm Configuration Page)

Alarm 1 Set Value : Adjustable between Alarm 1 Up Limit and Alarm 1 Low Limit.

Alarm 2 Set Value : Adjustable between Alarm 2 Up Limit and Alarm 2 Low Limit.

Alarm 3 Set Value : Adjustable between Alarm 3 Up Limit and Alarm 3 Low Limit. (In order to use Alarm 3 , **Output Type** parameter must be different from **Relay** otherwise Alarm 3 will be unavailable and Alarm 3 Conf page will be hidden.

Alarm 1 Hysteresis : Adjustable between 0 ... 50.

Alarm 1 Type : Independent alarm , Deviation alarm , Band alarm , Band Alarm with Inhibition can be selected.

Alarm 1 Status : For the Independent alarm, Band alarm or Band Alarm with Inhibition to be active below the set value LOW must be selected , to be active above the set value HIGH must be selected. If LOW is selected for Band alarm , alarm will be activated in band. If HIGH is selected , alarm will be activated out of band.

Alarm 1 Status During Probe Failure : For the alarm to be active in case of prob failure ON must be selected. For the alarm to be inactive in case of prob failure OFF must be selected.

Alarm 1 Up Limit : Adjustable between Scale Maximum and Alarm 1 Low Limit.

Alarm 1 Low Limit : Adjustable between Scale Minimum and Alarm 1 Up Limit.

Alarm 2 "Alarm 2 Conf" and Alarm 3 "Alarm 3 Conf" are programmed in the same way.

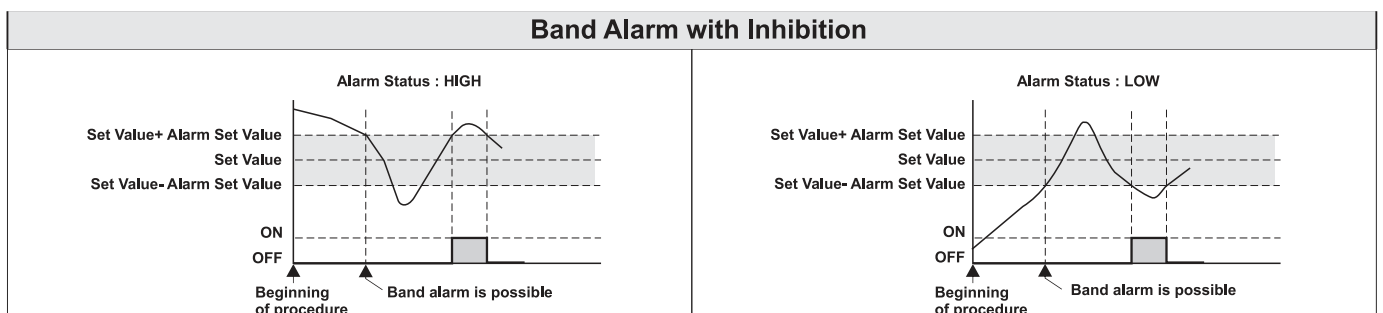
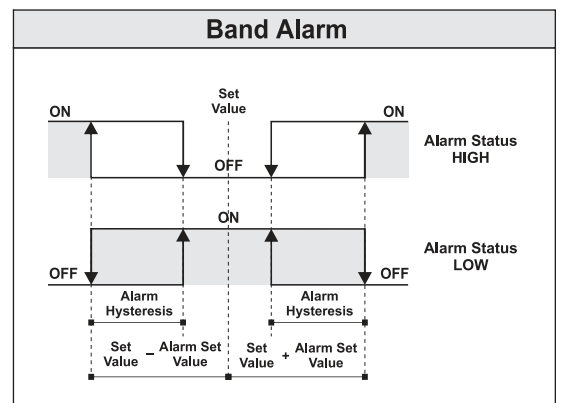
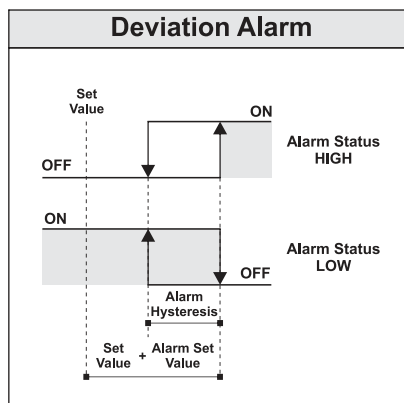
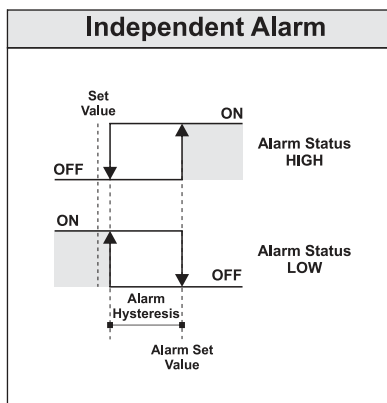



Programming PID Control (PID Control Configuration Page)

PID1 Control Conf	PID2 Control Conf
Proportional Band (%)	<input type="text" value="4.0"/>
Integral Time (min)	<input type="text" value="4.0"/>
Derivative Time (min)	<input type="text" value="1.0"/>
Control Period (sec)	<input type="text" value="4"/>
<input checked="" type="radio"/> Self Tune OFF <input type="radio"/> Self Tune ON	<input type="radio"/> Auto Tune OFF <input type="radio"/> Auto Tune ON

Proportional Band (%) : Adjustable between %0.0 ... %100.0.
 If proportional band is selected 0.0 , ON-OFF control will be activated.
Integral Time (min) : Adjustable between 0.0 ... 100.0 minute.
Derivate Time (min) : Adjustable between 0.0 ... 25.0 minute.
Control Period (sec) : Adjustable between 0 ... 250 second.
Auto Tune : It allows to improve PID parameters after Self Tune. In normal operation, it provides the best control by automatically changing the PID parameters in case the measured value oscillates. If Auto Tune ON selected, it is active and display shows AUTO TUNE RUNNING until Auto Tune is completed. Auto Tune OFF must be selected to stop the Auto Tune operation.

PID Self Tune :

Self Tune is started for PID1 and PID2 by selecting Self Tune On with   keys and pressing by  key.

If Self Tune is started for PID1 and PID2 separately, SELF TUNE IS STARTED and SELF TUNE IS RUNNING messages is shown respectively.
 If Self Tune is started for PID1 and PID2 together, SELF TUNE IS STARTED and SELF TUNE 1 AND SELF TUNE 2 RUNNING TOGETHER messages is show respectively. If Self Tune 1 finished and Self Tune 2 continues, SELF TUNE 1 FINISHED, SELF TUNE 2 RUNNING message is shown, If Self Tune 2 finished and Self Tune 1 continues, SELF TUNE 2 FINISHED, SELF TUNE 1 RUNNING message is shown.

When Self Tune process is successful:
 - SELF TUNE IS FINISHED message is shown and continues to control.

In order to start Selftune process PV must be smaller than %60 of SV , otherwise SELF TUNE IS STARTED and SELF TUNE IS STOPPED messages are shown respectively and home screen returned.
 User must wait until PV drops under %60 of SV and start selftune again.

If  key is pressed, SELF TUNE IS STOPPED message is shown and selftune is stopped and device turns back to home screen.

Modbus Conf	
Modbus Communication	<input checked="" type="radio"/> OFF <input type="radio"/> ON
Device Address	<input type="text" value="1"/>
Baudrate	<input type="text" value="9600"/>

Programming ModBus (Communication Configuration Page)

Modbus Communication : If parameter is selected ON modbus will be active , otherwise will be inactive.

Device Address : Adjustable between 1 ... 247

Baudrate : 4800, 9600, 19200, 38400 or 57600.

Security Code	<input type="text" value="0"/>
Input Configuration Page Visibility	<input type="text" value="Yes"/>
Output Configuration Page Visibility	<input type="text" value="Yes"/>
Alarm Group 1 Configuration Page Visibility	<input type="text" value="Yes"/>
Alarm Group 2 Configuration Page Visibility	<input type="text" value="Yes"/>
PID Control Configuration Page Visibility	<input type="text" value="Yes"/>
Communication Configuration Page Visibility	<input type="text" value="Yes"/>
Calibration Page Visibility	<input type="text" value="Yes"/>

Enter security code in order to change page visibilities.

Programming Keypad Security Level(Security Configuration Page)

Security Code : In order to change security configuration , Security Code must be entered 123.

Input Configuration Page Visibility : Yes, No or None.
Output Configuration Page Visibility : Yes, No or None.
Alarm Group 1 Configuration Page Visibility : Yes, No or None.
Alarm Group 2 Configuration Page Visibility : Yes, No or None.
PID Control Configuration Page Visibility : Yes, No or None.
Communication Configuration Page Visibility : Yes, No or None.
Calibration Page Visibility : Yes or None.

No : Page can be opened , parameters can not be changed.
 Yes : Page can be opened , parameters can be changed. None : Page can not be opened.

MODBUS ERROR MESSAGES

Modbus protocol has two types error, communication error and operating error. Reason of the communication error is data corruption in transmission. Parity and CRC control should be done to prevent communication error. Receiver side checks parity and CRC of the data. If they are wrong, the message will be ignored. If format of the data is true but function doesn't perform for any reason, operating error occurs. Slave realizes error and sends error message. Most significant bit of function is changed '1' to indicate error in error message by slave. Error code is sent in data section. Master realizes error type via this message.

ModBus Error Codes

Error Code	Name	Meaning
01	ILLEGAL FUNCTION	The function code received in the query is not an allowable action for the slave. If a Poll Program Complete command was issued, this code indicates that no program function preceded it.
02	ILLEGAL DATA ADDRESS	The data address received in the query is not an allowable address for the slave.
03	ILLEGAL DATA VALUE	A value contained in the query data field is not an allowable value for the slave.

Message example;

Structure of command message (Byte Format)

Device Address	(0A)h
Function Code	(01)h
Beginning address of coils.	MSB (04)h
	LSB (A1)h
Number of coils (N)	MSB (00)h
	LSB (01)h
CRC DATA	LSB (AC)h
	MSB (63)h

Structure of response message (Byte Format)

Device Address	(0A)h
Function Code	(81)h
Error Code	(02)h
CRC DATA	LSB (B0)h
	MSB (53)h

Modbus Address Map

Holding Registers

PARAMETER	INFORMATION	DATA TYPE	REG. ADR.	MIN.	MAX.	DEF.
Input1 Type	0 = B tipi Thermocouple 1 = E 2 = J 3 = K 4 = L 5 = N 6 = R 7 = S 8 = T 9 = U 10 = Pt100 11 = NTC 12 = 0-20 mA 13 = 4-20 mA 14 = 0-5 V 15 = 1-5 V 16 = 0-10 V 17 = 0-150 mV 18 = 0-550 Ohm 19 = 0-10 kOhm, (For Input1)	Word	0	0	19	2
Scale Minimum	Can not be changed for Thermocouple and PT100 . Can be changed for Universal Inputs. Scale Minimum is -100 for PT100 XXX.XX. Low limit for Set Value parameter. (For Input1)	Word	1	-32768	32767	-1000
Scale Maximum	Can not be changed for Thermocouple and PT100 . Can be changed for Universal Inputs. Scale Maximum is 160 for PT100 XXX.XX. Up limit for Set Value parameter. (For Input1)	Word	2	-32768	32767	9000
Unit	0 = °C 1 = °F 2 = Bar 3 = %RH 4 = Hz 5 = A 6 = V . (For Input1)	Word	3	0	6	0
Input1 Offset	Offset added to Measurement. (For Input1)	Word	4	-99	99	0
Digital Filter Coefficient	1 = Fastest response time 32 = Slowest response time Value of parameter should be increased in interference. (For Input1)	Word	5	1	32	4
Decimal Point	0 = XXX 1 = XXX.X 2 = XXX.XX 3 = XXX.XXX. According to Decimal Point parameter , modbus read/write data changed by 1,10,100,1000 linearly. (For Input1)	Word	6	0	3	1
Minimum Set Value	Adjustable between Scale Minimum and Maximum Set Value parameters. (For Input1)	Word	7	0	3	1
Maximum Set Value	Adjustable between Scale Maksimum and Minimum Set Value parameters. (For Input1)	Word	8	0	3	1
Input 2 Type	0 = B type Termokupl 1 = E 2 = J 3 = K 4 = L 5 = N 6 = R 7 = S 8 = T 9 = U 10 = Pt100 11 = NTC 12 = 0-20 mA 13 = 4-20 mA 14 = 0-5 V 15 = 1-5 V 16 = 0-10 V 17 = 0-150 mV 18 = 0-550 Ohm 19 = 0-10 kOhm, (For Input2)	Word	9	0	19	2
Scale Minimum	Can not be changed for Thermocouple and PT100 . Can be changed for Universal Inputs. Scale Minimum is -100 for PT100 XXX.XX. Low limit for Set Value parameter.	Word	10	-32768	32767	-1000
Scale Maximum	Can not be changed for Thermocouple and PT100 . Can be changed for Universal Inputs. Scale Maximum is 160 for PT100 XXX.XX. Up limit for Set Value parameter. (For Input2)	Word	11	-32768	32767	9000
Unit	0 = °C 1 = °F 2 = Bar 3 = %RH 4 = Hz 5 = A 6 = V . (For Input2)	Word	12	0	6	0
Input2 Offset	Offset added to Measurement. (For Input2)	Word	13	-99	99	0
Digital Filter Coefficient	1 = Fastest response time 32 = Slowest response time Value of parameter should be increased in interference. (For Input2)	Word	14	1	32	4
Decimal Point	0 = XXX 1 = XXX.X 2 = XXX.XX 3 = XXX.XXX. According to Decimal Point parameter , modbus read/write data changed by 1,10,100,1000 linearly. (For Input2)	Word	15	0	3	1
Minimum Set Value	Adjustable between Scale Minimum and Maximum Set Value parameters. (For Input2)	Word	16	0	3	1
Maximum Set Value	Adjustable between Scale Maksimum and Minimum Set Value parameters. (For Input2)	Word	17	0	3	1
Linearization Table1 [0-31].Points	Linearization table , value of points from 0 to 31. (For Input1)	Word	[18-49]	-32768	32767	0
Linearization Table2 [0-31].Points	Linearization table , value of points from 0 to 31. (For Input2)	Word	[50-81]	-32768	32767	0
Output1 Type	0 = Relay 1 = SSR 2 = 0-20 mA 3 = 4-20 mA 4 = 0-10 V (For Output1)	Word	82	0	4	0
Re-Transmission	0 = None 1 = 0-20 mA 2 = 4-20 mA 3 = 0-10 V (For Output1)	Word	83	0	3	0
Maximum Analog Output Value	(For Output1)	Word	84	0	100	100
Minimum Analog Output Value	(For Output1)	Word	85	0	100	0
Output1 Hysteresis	Adjustable between 1 and 50. (For Output1)	Word	86	0	50	0
Output1 Power Offset Around Set Point(%)	Added offset(%) according to error around Set Value. (For Output1)	Word	87	0	100	0
Output1 Power During Prob Failure(%)	Ajustable between %0 and %100 , output will continue in case of prob failure. (For Output1)	Word	88	0	100	0
Soft Start Time(sec)	Adjustable between 0 and 200 seconds. (For Output1)	Word	89	0	200	10
Output2 Type	0 = Relay 1 = SSR (For Output2)	Word	90	0	4	0
Output2 Hysteresis	Adjustable between 1 and 50. (For Output2)	Word	91	0	50	0
Output2 Power Offset Around Set Point(%)	Added offset(%) according to error around Set Value. (For Output2)	Word	92	0	100	0
Output2 Power During Prob Failure(%)	Ajustable between %0 and %100 , output will continue in case of prob failure. (For Output2)	Word	93	0	100	0
Soft Start Time(sec)	Adjustable between 0 and 200 seconds. (For Output2)	Word	94	0	200	10
Alarm 1 Set Value	Alarm Group1	Word	95	-32768	32767	1000
Alarm 2 Set Value	Alarm Group1	Word	96	-32768	32767	1000
Alarm 3 Set Value	Alarm Group1	Word	97	-32768	32767	1000
Alarm 1 Hysteresis	Alarm Group1	Word	98	0	50	0

Alarm 1 Type	0 =Independent 1=Deviation 2=Band alarm3=Band alarm with inhibition	Word	99	0	4	0
Alarm 1 Up Limit	Alarm Group1	Word	100	-32768	32767	9000
Alarm 1 Low Limit	Alarm Group1	Word	101	-32768	32767	-1000
Alarm 2 Hysteresis	Alarm Group1	Word	102	0	50	0
Alarm 2 Type	0 =Independent 1=Deviation 2=Band alarm3=Band alarm with inhibition	Word	103	0	4	0
Alarm 2 Up Limit	Alarm Group1	Word	104	-32768	32767	9000
Alarm 2 Low Limit	Alarm Group1	Word	105	-32768	32767	-1000
Alarm 3 Hysteresis	Alarm Group1	Word	106	0	50	0
Alarm 3 Type	0 =Independent 1=Deviation 2=Band alarm3=Band alarm with inhibition	Word	107	0	3	0
Alarm 3 Up Limit	Alarm Group1	Word	108	-32768	32767	9000
Alarm 3 Low Limit	Alarm Group1	Word	109	-32768	32767	-1000
Alarm 1 Set Value	Alarm Group2	Word	110	-32768	32767	1000
Alarm 2 Set Value	Alarm Group2	Word	111	-32768	32767	1000
Alarm 3 Set Value	Alarm Group2	Word	112	-32768	32767	1000
Alarm 1 Hysteresis	Alarm Group2	Word	113	0	50	0
Alarm 1 Type	0 =Independent 1=Deviation 2=Band alarm3=Band alarm with inhibition	Word	114	0	4	0
Alarm 1 Up Limit	Alarm Group2	Word	115	-32768	32767	9000
Alarm 1 Low Limit	Alarm Group2	Word	116	-32768	32767	-1000
Alarm 2 Hysteresis	Alarm Group2	Word	117	0	50	0
Alarm 2 Type	0 =Independent 1=Deviation 2=Band alarm3=Band alarm with inhibition	Word	118	0	4	0
Alarm 2 Up Limit	Alarm Group2	Word	119	-32768	32767	9000
Alarm 2 Low Limit	Alarm Group2	Word	120	-32768	32767	-1000
Alarm 3 Hysteresis	Alarm Group2	Word	121	0	50	0
Alarm 3 Type	0 =Independent 1=Deviation 2=Band alarm3=Band alarm with inhibition	Word	122	0	3	0
Alarm 3 Up Limit	Alarm Group2	Word	123	-32768	32767	9000
Alarm 3 Low Limit	Alarm Group2	Word	124	-32768	32767	-1000
Proportional Band (%)	If it is set to %0.0 , ON-OFF control is activated. If it is set to different from%0.0 , PID control is activated. In order to read/write from modbus mutiple/divide with 10. For example ; in order to set %5.5 , 5.5x10=55 must be written to parameter.(For PID1)	Word	125	0	100	4
Integral Time (min)	Adjustable between 0.0 and 100.0. If it is set to 0.0 , PD control is activated. In order to read/write from modbus mutiple/divide with 10. For example ; in order to set %5.5 , 5.5x10=55 must be written to parameter.(For PID1)	Word	126	0	100	4
Derivative Time (min)	Adjustable between 0.0 and 25.0 If it is set to 0.0 , PI control is activated. In order to read/write from modbus mutiple/divide with 10. For example ; in order to set %5.5 , 5.5x10=55 must be written to parameter.(For PID1)	Word	127	0	25	1
Control Period (sec)	Adjustable between 1 and 250 second.(For PID1)	Word	128	1	250	4
Proportional Band (%)	If it is set to %0.0 , ON-OFF control is activated. If it is set to different from%0.0 , PID control is activated. In order to read/write from modbus mutiple/divide with 10. For example ; in order to set %5.5 , 5.5x10=55 must be written to parameter.(For PID2)	Word	129	0	100	4
Integral Time (min)	Adjustable between 0.0 and 100.0. If it is set to 0.0 , PD control is activated. In order to read/write from modbus mutiple/divide with 10. For example ; in order to set %5.5 , 5.5x10=55 must be written to parameter.(For PID2)	Word	130	0	100	4
Derivative Time (min)	Adjustable between 0.0 and 25.0 If it is set to 0.0 , PI control is activated. In order to read/write from modbus mutiple/divide with 10. For example ; in order to set %5.5 , 5.5x10=55 must be written to parameter.(For PID2)	Word	131	0	25	1
Control Period (sec)	Adjustable between 1 and 250 second.(For PID2)	Word	132	1	250	4
Set Value1		Word	133	-32768	32767	2000
Set Value2		Word	134	-32768	32767	2000

According to the value of Decimal Point parameter; "Scale Minimum", "Scale Maximum", "Linearization Table Points", "Alarm 1 Set Value", "Alarm 2 Set Value", "Alarm 3 Set Value", "Alarm 1 Up Limit", "Alarm 1 Low Limit", "Alarm 2 Up Limit", "Alarm 2 Low Limit", "Alarm 3 Up Limit" and the "Alarm 3 Low Limit" parameters changes linearly when read via ModBus and when written, with 1,10,100,1000.

For example ;

When the value of the Decimal Point parameter is 1, it is 155.5 if the Set Value Parameter is written as 1555 via ModBus.

Input Registers

PARAMETER	INFORMATION	DATA TYPE	REG. ADR.	MIN.	MAX.	DEF.
Measured Value1(PV1)	Measured PV , result must be divided by 10. For example; If temperature is 32.5 °C , 325 will be read over modbus.	Word	0	NONE	NONE	NONE
Measured Value2(PV2)	Measured PV , result must be divided by 10. For example; If temperature is 32.5 °C , 325 will be read over modbus.	Word	1	NONE	NONE	NONE
Internal NTC Temperature	Measured Internal NTC temperature , result must be divided by 10. For example; If temperature is 32.5 °C , 325 will be read over modbus.	Word	2	NONE	NONE	NONE
Analog Output Percentage	Output % for 0-10V , 0-20mA or 4-20mA (For Ouput1)	Word	3	NONE	NONE	NONE
Analog Output Percentage	Output % for 0-10V , 0-20mA or 4-20mA (For Ouput2)	Word	4	NONE	NONE	NONE

Coil Registers

PARAMETER	INFORMATION	DATA TYPE	REG. ADR.	MIN.	MAX.	DEF.
Use Linearization Table1	Disable/Enable Linearization table Can not be used for Thermocouple , PT100 and NTC . Can be used for Universal Inputs.(For Input1)	Bit	0	0	1	0
Use Linearization Table2	Disable/Enable Linearization table Can not be used for Thermocouple , PT100 and NTC . Can be used for Universal Inputs.(For Input2)	Bit	1	0	1	0
Control Configuration	0=ON-OFF COOLING 1=ON-OFF HEATING IfProportional Band parameter is %0 , ON-OFF control activated.(For Output1)	Bit	2	0	1	1
Control Configuration	0=ON-OFF COOLING 1=ON-OFF HEATING Ifproportional Band parameter is %0 , ON-OFF control activated.(For Output2)	Bit	3	0	1	1
Alarm 1 Status	0= LOW 1= HIGH Alarm Group1	Bit	4	0	1	1
Alarm 1 Status During Prob Failure	0=OFF , alarm is inactive in case ofprob failure. 1=ON , alarm is active in case ofprob failure. Alarm Group1	Bit	5	0	1	1
Alarm 2 Status	0= LOW 1= HIGH Alarm Group1	Bit	6	0	1	1
Alarm 2 Status During Prob Failure	0=OFF , alarm is inactive in case ofprob failure. 1=ON , alarm is active in case ofprob failure. Alarm Group1	Bit	7	0	1	1
Alarm 3 Status	0= LOW 1= HIGH Alarm Group1	Bit	8	0	1	1
Alarm 3 Status During Prob Failure	0=OFF , alarm is inactive in case ofprob failure. 1=ON , alarm is active in case ofprob failure. Alarm Group1	Bit	9	0	1	1
Alarm 1 Status	0= LOW 1= HIGH Alarm Group2	Bit	10	0	1	1
Alarm 1 Status During Prob Failure	0=OFF , alarm is inactive in case ofprob failure. 1=ON , alarm is active in case ofprob failure. Alarm Group2	Bit	11	0	1	1
Alarm 2 Status	0= LOW 1= HIGH Alarm Group2	Bit	12	0	1	1
Alarm 2 Status During Prob Failure	0=OFF , alarm is inactive in case ofprob failure. 1=ON , alarm is active in case ofprob failure. Alarm Group2	Bit	13	0	1	1
Alarm 3 Status	0= LOW 1= HIGH Alarm Group2	Bit	14	0	1	1
Alarm 3 Status During Prob Failure	0=OFF , alarm is inactive in case ofprob failure. 1=ON , alarm is active in case ofprob failure. Alarm Group2	Bit	15	0	1	1
Auto Tune	0 = OFF 1 = ON , Improve PID parameters while selftune is running. IfPV is oscillating while profile control is running , autotune will improve PID parameters in order to best control. (For PID1)	Bit	16	0	1	0
Auto Tune	0 = OFF 1 = ON , Improve PID parameters while selftune is running. IfPV is oscillating while profile control is running , autotune will improve PID parameters in order to best control.(For PID2)	Bit	17	0	1	0

Discrete Input Registers

PARAMETER	INFORMATION	DAT A	REG. ADR.	MIN.	MAX.	DEF.
C/A3 Output Status	Control Relay / Alarm3 output state(0 = OFF , 1 = ON) (For Ouput1)	Bit	0	NONE	NONE	NONE
A1 Output Status	Alarm1 output state(0 = OFF , 1 = ON) (For Ouput1)	Bit	1	NONE	NONE	NONE
A2 Output Status	Alarm2 output state(0 = OFF , 1 = ON) (For Ouput1)	Bit	2	NONE	NONE	NONE
SSR Output Status	SSR output state(0 = OFF , 1 = ON) (For Ouput1)	Bit	3	NONE	NONE	NONE
Prob Failure Status	Prob failure(0 = OFF , 1 = ON) (For Ouput1)	Bit	4	NONE	NONE	NONE
C/A3 Output Status	Control Relay / Alarm3 output state(0 = OFF , 1 = ON) (For Ouput2)	Bit	5	NONE	NONE	NONE
A1 Output Status	Alarm1 output state(0 = OFF , 1 = ON) (For Ouput2)	Bit	6	NONE	NONE	NONE
A2 Output Status	Alarm2 output state(0 = OFF , 1 = ON) (For Ouput2)	Bit	7	NONE	NONE	NONE
SSR Output Status	SSR output state(0 = OFF , 1 = ON) (For Ouput2)	Bit	8	NONE	NONE	NONE
Prob Failure Status	Prob failure(0 = OFF , 1 = ON) (For Ouput2)	Bit	9	NONE	NONE	NONE