



Read this document carefully before using this device. The guarantee will be expired by damaging of the device if you don't attend to the directions in the user manual. Also we don't accept any compensations for personal injury, material damage or capital disadvantages.

ENDA EUC942 PID UNIVERSAL CONTROLLER

Thank you for choosing ENDA EUC942 universal controller.

- * 96 x 96mm sized.
- * Selectable sensor type.
- * Selectable 0-20mA or 4-20mA input.
- * Automatic calculation of PID parameters (SELF TUNE).
 - ⚠ Enter PID parameters of the system if they are known at the beginning. Otherwise, Self-Tune should be activated.
- * Soft-Start.
- * Communication via RS-485 ModBus protocol (Optional).
- * Selectable analog, SSR or relay control output.
- * Selectable 0-20mA or 4-20mA analog control output.
- * Relay output can be programmable as second alarm or control output.
- * AL1 relay output for first alarm out.
- * Selectable Heat/Cool control.
- * Input offset feature.
- * In the case of sensor failure periodical running or relay state can be selected.
- * Panel or ModBus can be done through the control outputs.
- * Parameter access protection on 3 levels.
- * Programming by using keypad or Modbus.
- * CE marked according to European Norms.



RoHS
Compliant

TECHNICAL SPECIFICATIONS

Input type	Temperature range		Accuracy
	°C	°F	
PT100 Resistance Thermometer EN 60751	-200...600 °C	-328... +1112 °F	± 0,2% (of full scale) ± 1 digit
PT100 Resistance Thermometer EN 60751	-99.9...300.0 °C	-99.9...+543.0 °F	± 0,2% (of full scale) ± 1 digit
J (Fe-CuNi) Thermocouple EN 60584	0... 600 °C	+32... +1112 °F	± 0,2% (of full scale) ± 1 digit
K (NiCr-Ni) Thermocouple EN 60584	0...1200 °C	+32... +2192 °F	± 0,2% (of full scale) ± 1 digit
T (Cu-CuNi) Thermocouple EN 60584	0... 400 °C	+32... +752 °F	± 0,2% (of full scale) ± 1 digit
S (Pt10Rh-Pt) Thermocouple EN 60584	0...1600 °C	+32... +2912 °F	± 0,2% (of full scale) ± 1 digit
R (Pt13Rh-Pt) Thermocouple EN 60584	0...1600 °C	+32... +2912 °F	± 0,2% (of full scale) ± 1 digit
0-20 mA EN 60584	-999...4000		± 0,2% (of full scale) ± 1 digit
4-20 mA EN 60584	-999...4000		± 0,2% (of full scale) ± 1 digit

ENVIRONMENTAL CONDITIONS	
Ambient/storage temperature	0 ... +50°C/-25... +70°C (with no icing)
Max. Relative humidity	80% up to 31°C decreasing linearly 50% at 40°C.
Rated pollution degree	According to EN 60529 Front panel : IP65 Rear panel : IP20
Height	Max. 2000m

⚠ Do not use the device in locations subject to corrosive and flammable gases.

ELECTRICAL CHARACTERISTICS	
Supply	90-250V AC, 50/60Hz or 9-30V DC/7-24V AC
Power consumption	Max. 7VA
Wiring	2.5mm ² screw-terminal connections
Line resistance	For thermocouple max.100ohm, for 3 wired PT100 max. 20ohm
Data retention	EEPROM (minimum 10 years)
EMC	EN 61326-1: 1997, A1: 1998, A2: 2001 (Performance criterion B for standard EN 61000-4-3)
Safety requirements	EN 61010-1: 2001 (Pollution degree 2, overvoltage category II)

OUTPUTS	
CONT./AL2	Relay : 250V AC, 2A (for resistive load), NO/NC. Selectable as Control or Alarm2 output.
AL1	Relay : 250V AC, 2A (for resistive load), NO/NC selectable. (Alarm1 output).
ANL/SSR	Selectable as 0-20mA, 4-20mA analog output or logic control output.
Life expectancy for relay	Mechanical 30.000.000 operation; Electrical 300.000 operation

CONTROL	
Control type	Single set-point and alarm control
Control algorithm	On-Off / P, PI, PD, PID (selectable)
A/D converter	15 bits
Sampling time	500ms
Proportional band	Adjustable between 0% and 100%. If Pb=0%, On-Off control is selected.
Integral time	Adjustable between 0.0 and 100.0 minutes
Derivative time	Adjustable between 0.00 and 25.00 minutes
Control period	Adjustable between 1 and 250 seconds
Hysteresis	Adjustable between 1 and 50°C/F
Output power	The ratio of power at a set point can be adjusted between 0% and 100%

HOUSING	
Housing type	Suitable for flush-panel mounting according to DIN 43 700.
Dimensions	W96xH96xD50mm
Weight	Approx. 410g (after packing)
Enclosure material	Self extinguishing plastics.



While cleaning the device, solvents (thinner, benzene, acid etc.) or corrosive materials must not be used.

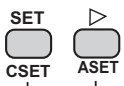

If key is pressed while holding key, the programming mode is enabled.

Cono.

Pb
4

Pb = Proportional band.
Adjustable between 0% and 100%.
Setting **Pb** = 0% On-Off control is selected.

t_i
40

t_i = Integral time.
Adjustable between 0.0 and 100.0 minutes.
If **t_i** = 0.0, integral effect is not used.
Setting **Pb** = 0 this parameter is not seen.

t_d
100

t_d = Derivative time.
Adjustable between 0.00 and 25.00 minutes.
If **t_d** = 0.00, derivation effect is not used.
Setting **Pb** = 0 this parameter is not seen.

ct
20

ct = Control period.
Adjustable between 1 and 250 seconds.
Setting **Pb** = 0 and **Cont. out 1** this parameter is not seen.

PSEt
0

PSEt = The ratio of output power at the set point. Adjustable between 0% and 100%.
If this parameter is set to 0, the output power becomes 0 at the set point. If it is adjusted to 50% output power becomes 50% at the set point. Using this parameter the energy requirements of the system is adjusted at the set point. So the set point can be achieved by minimum fluctuations and in the shortest time.
Setting **Pb** = 0, this parameter is not seen.

CHYS
2

CHYS = Hysteresis of the control output.
Adjustable between 1 and 50 °C/F.
Adjustable between 0,1 and 5,0 °C/F, if **inP**=**PT100** setting **Pb**=0, this parameter is seen. Hysteresis decimal scale value can be adjusted between 0.1°C and 5.0°C for PT100.

CSEt
HEAt

CSEt = Configuration of the control output.
CSEt = **HEAt** means heating control.
CSEt = **cool** means cooling control.

PrEr
0

PrEr = This parameter is used to adjust the control output during a sensor failure.
Adjustable between 0% and 100%.
If this parameter is adjusted to a value closer to the energy requirements of the system at the set point, process temperature is prevented to rise or drop to dangerous levels.

Cont. out 1
out 1

Cont. out 1 = Type of control output
out 1 = Out1 control output.
0-20 = Analog control output.
(0mA %0 energy, 20mA %100 energy)
Out1 = Alarm2 output.
4-20 = Analog control output.
(4mA %0 energy, 20mA %100 energy)
Out1 = Alarm2 output.
SSr = SSR control output.
Out1=Alarm2 output.

SSSt
0

SSSt = Soft Start timer set point value
This parameter indicates the time to reach set point value when the device is first energized.
Adjustable between 0 and 250 minutes.
If 0 is selected, soft start feature will be enable and the device reaches set point value quickly.
NOTE! Setting **Pb** = 0, soft start feature will be disable.

RoLL

RoLL = Minimum analog output value (% output) ,adjustable between 0 and 100.

RoHL

RoHL = Maximum analog output value (% output) ,adjustable between 0 and 100.

ALro.

AlHY
2

AlHY = Hysteresis of the Alarm1 output.
Adjustable between 1 and 50°C.
Hysteresis decimal scale value can be adjusted between 0.1°C and 5.0°C for

AlEP
indE

AlEP = Function of Alarm1 output.
Four kinds of functions can be selected.
indE = Independent
dE = Deviation
bAnd = Band
bAn.i = Band with inhibition

AlSt
H_i

AlSt = The state of Alarm1.
If independent or deviation alarm is selected, this parameter can be **L_o** and **H_i**. For **L_o** alarm output is energized below the alarm set point. For **H_i** alarm output is energized above the alarm set point. If band alarm is selected, this parameter can be **b_iH_i** or **boH_i**. **b_iH_i** means alarm is activated inside the band. **boH_i** means alarm is activated outside the band.

AlPE
on

AlPE = State of Alarm1 output in the case of sensor failure.
If **AlPE**=**on**, the alarm output is energized during the sensor failure.
If **AlPE**=**oFF**, the alarm output is not energized during the sensor failure.

A2HY
2

A2HY = Hysteresis of the Alarm2 output.
Adjustable between 1 and 50°C.
NOTE! If **Cont. out 1**, this parameter is not seen.

A2EP
indE

A2EP = Function of Alarm2 output.
Four kinds of functions can be selected.
indE = Independent
dE = Deviation
bAnd = Band
bAn.i = Band with inhibition
NOTE! If **Cont. out 1**, this parameter is not seen.

A2St
H_i

A2St = The state of Alarm2.
If independent or deviation alarm is selected, this parameter can be **L_o** and **H_i**. For **L_o** alarm output is energized below the alarm set point. For **H_i** alarm output is energized above the alarm set point. If band alarm is selected, this parameter can be **b_iH_i** or **boH_i**. **b_iH_i** means alarm is activated inside the band. **boH_i** means alarm is activated outside the band.
NOTE! If **Cont. out 1**, this parameter is not seen.

A2PE
oFF

A2PE = State of Alarm2 output in the case of sensor failure.
If **A2PE**=**on**, the alarm output is energized during the sensor failure.
If **A2PE**=**oFF**, the alarm output is not energized during the sensor failure.
NOTE! If **Cont. out 1**, this parameter is not seen.

Conf.

inP
FEcn

inP = Type of input and scale.
PT = PT100 -200 to +600°C
PLD = PT100 -99.0 to +300.0°C
FEcn = J (Iron vs. Copper-Nickel) 0 to +600°C
ncnR = K (Nickel-Cr.vs. Nickel-Alum.) 0 to +1200°C
ccn = T (Copper vs. Copper-Nickel) 0 to +400°C
P13r = S (Platinum-10%Rhodium vs. Pt.) 0 to +1600°C
P13r = R (Platinum-13%Rhodium vs. Pt.) 0 to +1600°C
0-20 = 0-20 mA -999 to 3000
4-20 = 4-20 mA -999 to 3000
Note: If the selected input type is changed, the value of **CHiL**, **CLoL**, **AlHL**, **AlLL** parameters changes automatically.

CHiL
600

CHiL = Set point upper limit.
If **inP** or **UnIt** parameters are changed, the maximum value of the **CHiL** parameter changes to the maximum scale value of the selected input. The minimum value is the value of **CLoL** parameter.

CLoL
0

CLoL = Set point lower limit.
If **inP** or **UnIt** parameters are changed, the minimum value of the **CLoL** parameter changes to the minimum scale value of the selected input. The maximum value is the value of **CHiL** parameter.

oFFs
0

oFFs = Offset value.
Offset value is added to the measurement value.
Adjusted between -99 and +99°C.
The normal value is 0.
Decimal scale value can be adjusted between -9.9°C and 9.9°C for PT100.

UnIt
oC

UnIt = The temperature unit.
Selectable as °C or °F.
Note: If the temperature unit is changed, the value of the **UnIt**, **CLoL**, **AlHL**, **AlLL** parameters changes automatically.
NOTE! If **inP** parameter is selected TC or PT100, this parameter is seen.

AlHL
600

AlHL = Alarm1 value upper limit.
If **inP** or **UnIt** parameters are changed, the maximum value of the **AlHL** parameter changes to the maximum scale value of the selected input type. Minimum of **AlHL** parameter is the value of **AlLL** parameter.

AlLL
0

AlLL = Alarm1 value lower limit.
If **inP** or **UnIt** parameters are changed, the minimum value of the **AlLL** parameter changes to the minimum scale value of the selected input type. The maximum value is the value of **AlHL** parameter.

A2HL
600

A2HL = Alarm2 value upper limit.
If **inP** or **UnIt** parameters are changed, the maximum value of the **A2HL** parameter changes to the maximum scale value of the selected input type. Minimum of **A2HL** parameter is the value of **A2LL** parameter.
NOTE! If **Cont. out 1**, this parameter is not seen.

A2LL
0

A2LL = Alarm2 value lower limit.
If **inP** or **UnIt** parameters are changed, the minimum value of the **A2LL** parameter changes to the minimum scale value of the selected input type. The maximum value is the value of **A2HL** parameter.
NOTE! If **Cont. out 1**, this parameter is not seen.

FLCo
5

FLCo = Coefficient of digital filter.
Filter for display value.
Adjustable between 1 and 32. If this parameter is 1, digital filter runs most quick. If the parameter is 31, the filter run most slow. The value of parameter should be increased in interference.

Modification of Parameter

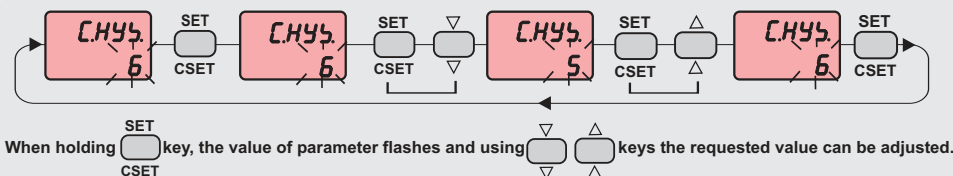

When holding key, the value of parameter flashes and using keys the requested value can be adjusted.

If key is pressed and held 0.6 seconds, the value of the selected parameter changes rapidly. If waited enough, the value increases 100 at each step. After 1 second following the release of the key, initial condition is returned. The same procedure is valid for the decrement key.

Entering from the programming mode to the run mode:

If no key is pressed within 20 seconds during programming mode, the data is stored automatically and the run mode is entered.

Alternatively, the same function occurs first pressing key and then pressing keys together.

Page 2/5

ConF. Page 2/5

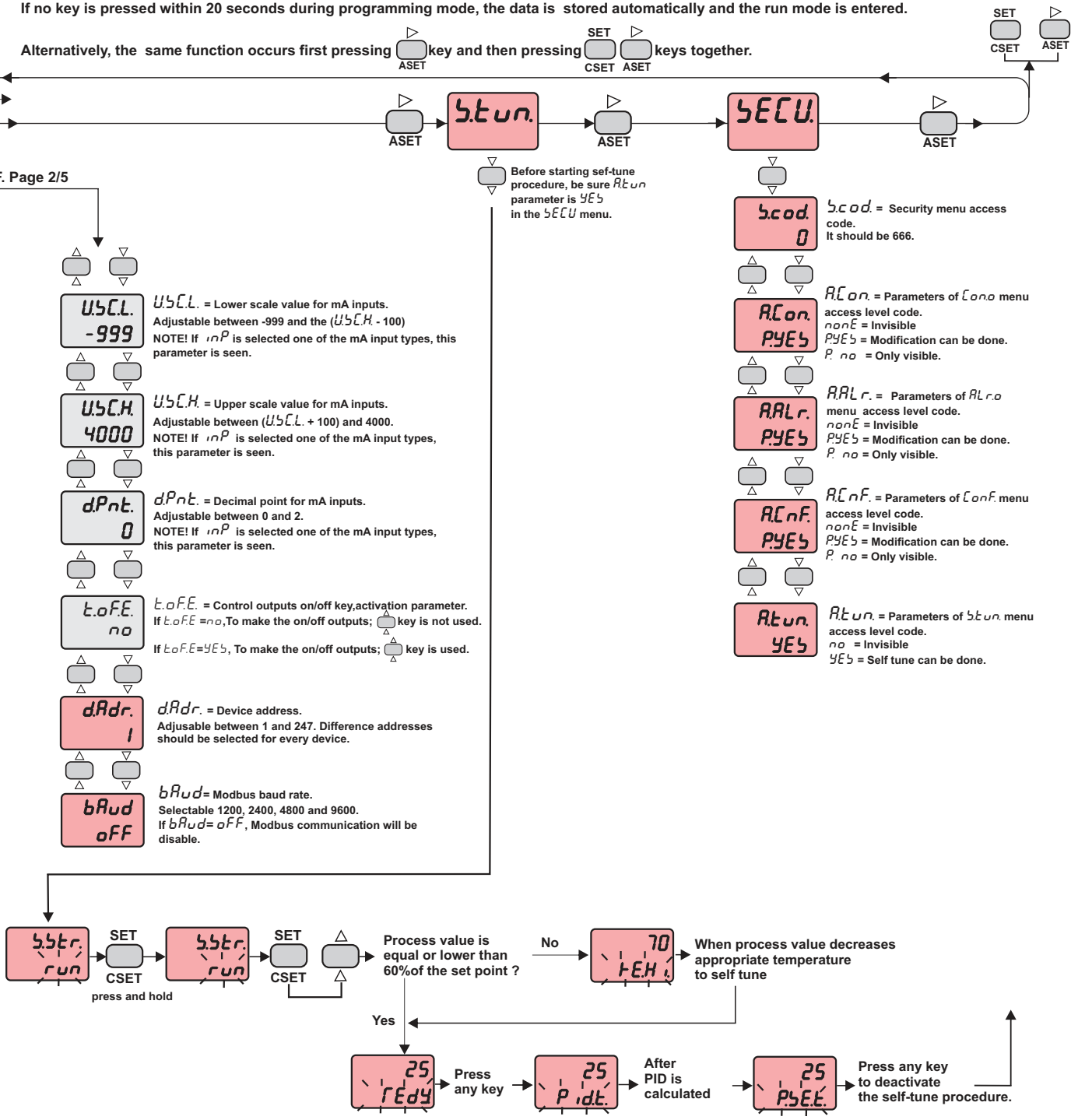

While holding key, *run* message flashes. Then when key is pressed, self tune mode is entered if there is no probe failure. If process value is appropriate to begin self tune, *rEdY* message flashes. Then press any key to see *P idt.* message and self tune procedure begins.

Process value must be equal or lower than 60% of the setpoint to begin self tune procedure. If not, *tEH.* message flashes and device waits to decrease appropriate temperature to begin self tune. Then *rEdY* message flashes and press any key to begin self tune procedure.

Before self tune procedure, *Rtun.* parameter must be selected *YEs* from the *SECU* menu. If self tune is achieved *Rtun.* parameter becomes *no* automatically and *Stun* menu is canceled. Before self tune procedure, temperature setpoint value should be adjusted. When self tune procedure begins with no failure, *P idt.* message flashes and remains during the calculation of PID parameters. When PID parameters are calculated, *P5Et.* message flashes. Then the device heats until setpoint value according to PID parameters and calculates the energy requirement for stable temperature and writes *P5Et.* parameter as % and run mode enters.

If any key is pressed while *P idt.* message flashes, self tune procedure is deactivated before calculation of PID parameters. If any key is pressed while *P5Et.* message flashes, then self tune procedure is deactivated as PID parameters are calculated and *P5Et.* parameter is done *U*.

(1) Process value during normal operation
Mnemonic parameter code during programming

(2) Set point during normal operation.
Data value during programming

(3) Increment key during normal operation and programming
Parameter selection key during programming

(4) Decrement key during normal operation
If only this key is pressed in normal operation, software version number is seen.
Parameter selection key during programming

(5) Alarm set key during normal operation
Menu selection key during programming

(6) Control set key during normal operation
Parameter selection key during programming

(7) State indicator

(1) PV display	4 digits 7 segment red LED
(2) SV display	4 digits 7 segment yellow LED
Character heights	PV display :20 mm
	SV display :14 mm
(3),(4),(5),(6) Keypad	Micro switch
(7) State indicator	3 red LEDs for Control, Alarm1 and SSR outputs

ALARM1 AND ALARM2 OUTPUT TYPES

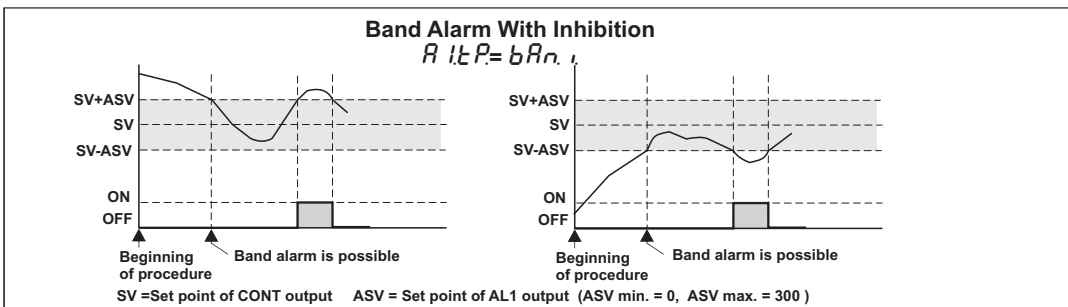
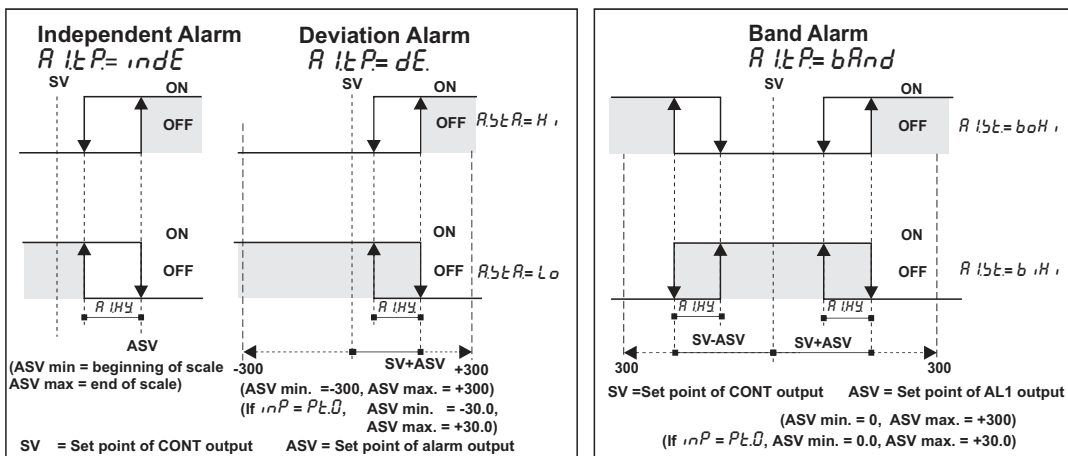

MODIFICATION OF CONTROL AND ALARM SET POINTS

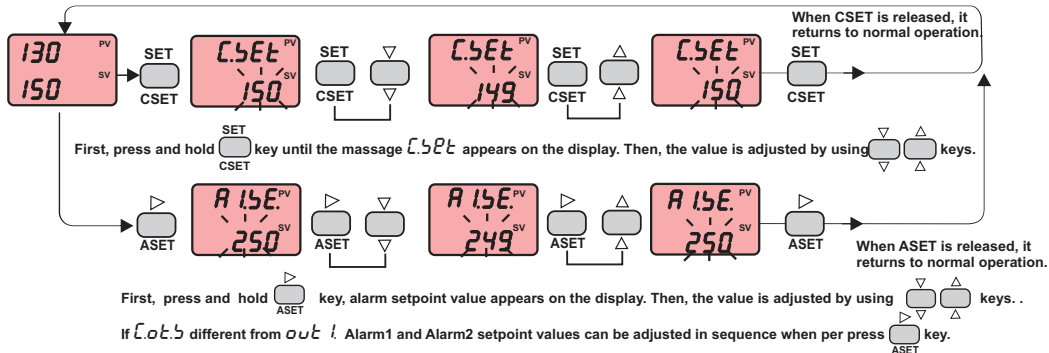

NOTE: The maximum of **C5Et** is the value of **CH1L** parameter and the minimum of it is the value of **CL0L** parameter.
 If independent alarm is selected, **A1SE** and **A2SE** values can be adjusted between the limits of the full scale.
 If deviation alarm is selected, **A1SE** and **A2SE** values can be adjusted between -300 and +300.
 If band alarm is selected, **A1SE** and **A2SE** values can be adjusted between 0 and +300.

Error Messages

Temperature value is higher than the scale	Temperature value is lower than the scale	Temperature sensor is broken or over temperature	PT100 or a sensor line is short circuited

DIMENSIONS

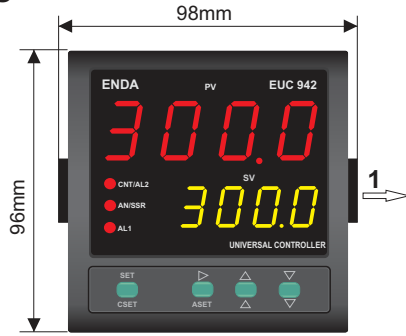

For removing the device from the panel:
-While pressing both side of the device in direction 1, push it in direction 2.

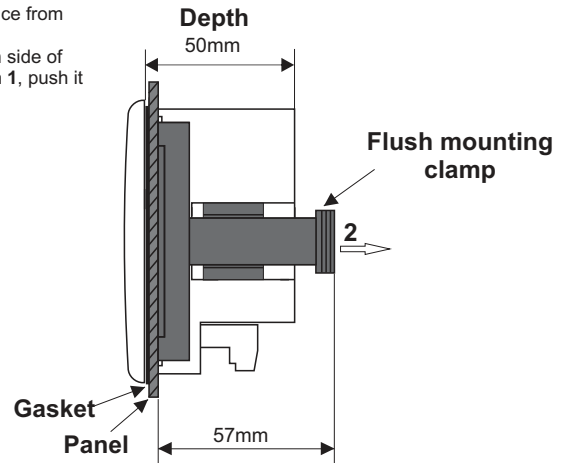

Panel cut-out

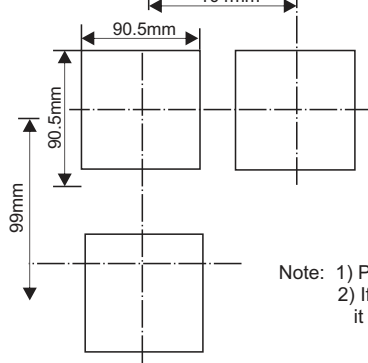

Note: 1) Panel thickness should be maximum 10mm.
2) If there is no 60mm free space at back side of the device, it would be difficult to remove it from the panel.

CONNECTION DIAGRAM



ENDA EUC942 is intended for installation in control panels. Make sure that the device is used only for intended purpose. The shielding must be grounded on the instrument side. During an installation, all of the cables that are connected to the device must be free of energy. The device must be protected against inadmissible humidity, vibrations, severe soiling and make sure that the operation temperature is not exceeded. All input and output lines that are not connected to the supply network must be laid out as shielded and twisted cables. These cables should not be close to the power cables or components. The installation and electrical connections must be carried on by a qualified staff and must be according to the relevant locally applicable regulations.

Screw-terminal connections

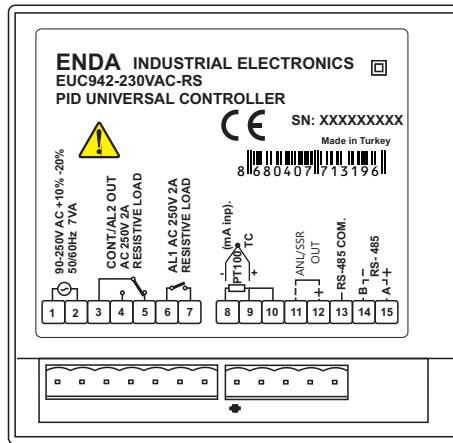
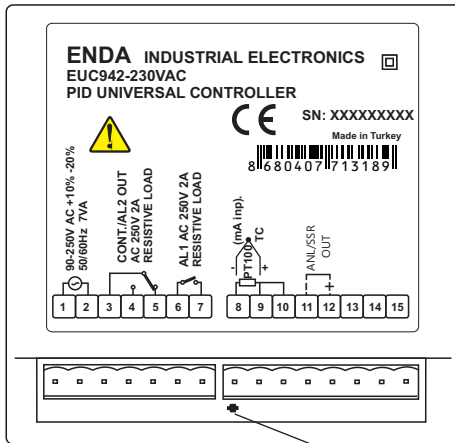

Logic output of the instrument is not electrically insulated from the internal circuits. Therefore, when using a grounding thermocouple, do not connect the logic output terminals to the ground.

Note 1) Mains supply cords shall meet the requirements of IEC 60227 or IEC 60245.

2) In accordance with the safety regulations, the power supply switch shall bring the identification of the relevant instrument and it should be easily accessible by the operator.



Holding screw
0.4-0.5Nm



Equipment is protected throughout by DOUBLE INSULATION.

Environment temperature measurement sensor

NOTE :

SUPPLY :

90-250V AC or
21.6-26.4V AC
50/60Hz 5VA

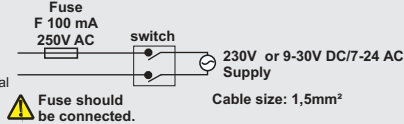

Fuse should be connected.

SENSOR INPUT :

For J-K-T-S-R type thermocouple :
Use suitable compensation cables. Don't use jointed cables. Pay attention to the polarities of the thermocouple cables as shown in the figure right are connected to the .

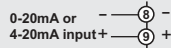
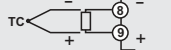

For resistance thermometer :
When 2 wired PT100 is used, terminals 9 and 10 must be short circuited.

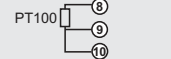

Order Code : EUC942-□□□□□□-□□
1 2

1- Supply Voltage

230VAC...90-250V AC
SM.....9-30V DC / 7-24V AC

2- Modbus Option

RS.....RS-485 Modbus communication
None....No RS-485 Modbus communication