



Read this document carefully before using this device. The guarantee will be expired by device damages if you don't attend to the directions in user manual. Also we don't accept any compensations for personal injury, material damage or capital disadvantages.

ENDA ATSP01 Rail Mountable Multi Functional Analog Timer

Thank you for choosing ENDA ATSP01 rail mountable multi functional analog timer.



- * Start by supply voltage
- * Contact output (OUT) for the timing function
- * 6 different timing mode (A,B,C,D,E,F)
- * 6 different timing unit (S, 10S, M, 10M, H, 10H)
- * Rail mountable
- * Screw-terminal connection
- * CE marked according to European norms



ORDER CODE

ATSP01-xV

Product basic code
Rail mountable multi
functional analog timer

Supply voltage
UV 90-250V AC
LV 24V AC/DC

Technical Specifications

ENVIRONMENTAL CONDITIONS	
Ambient/storage temperature	0 ... +50°C/-25 ... +70°C (in the environment icing and condensation should not be.)
Max. relative humidity	80%, up to 31°C decreasing linearly 50% at 40°C
Rated pollution degree	IP20, According to EN 60529
Height	Max. 2000m

Do not use the device in locations subject to corrosive and flammable gasses.

ELECTRICAL CHARACTERISTICS	
Supply voltage	90-250V AC \pm 10 %/20, 50/60Hz or 24V AC \pm 10, 50/60Hz or 24V DC \pm 10
Power consumption	Max. 10VA
Connection	Screw-terminal connection.
Scale	0-1
Reset time	For ATSP01-UV max. 0.3 seconds, for ATSP01-LV max. 0.01 seconds.
Accuracy	Depending on the effect of voltage: max %0.2 Depending on the set value settings: max %4.5 Depending on the effect of temperature :max %1
EMC	EN 61326-1: 2006
Safety requirements	EN 61010-1: 2010 (pollution degree 2, overvoltage category II)
Insulation test voltage	3kV AC min. 1 minute, 4,2kV DC min. 1 minute.

OUTPUTS	
Control outputs (OUT)	Relay: 250V AC, 8A (for resistive load), NO+NC
Life expectancy for relay	Without load 30.000.000 operation; 250V AC, 8A resistive load 100.000 operation.
Control output state	When control output is energized OUT LED becomes on. While the timer running flash.
CONTROL	
Timing function	A, B, C, D, E, F Modes (Can be selected from the device.)
Timing unit	Second, 10second, minute, 10minute, hour, 10hour (Can be selected from the device.)
HOUSING	
Mounting	Rail mountable (EN 60715, Th35)
Dimensions	W18xH84xD62mm
Weight	Approx. 90g (after packaging)
Enclosure material	Kendi kendine sönen plastikler kullanılmıştır.

While cleaning the device, solvents (thinner, benzene, acid etc.) or corrosive materials must not be used.

OUTPUT CONTROL

ATSP01 - xV

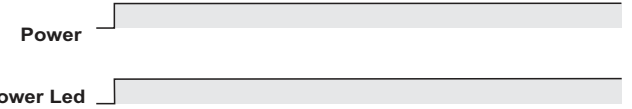

Mode (A,B,C,D,E,F)

Output Graphic (t : manipulated time)

Mode A :
For the relay to trigger
delayed timing

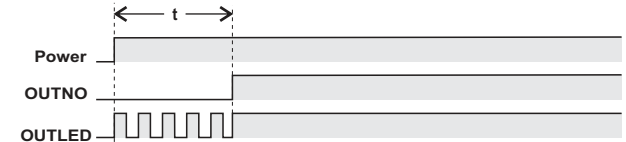

Mode B :
The relay's beginning to
trigger last timing

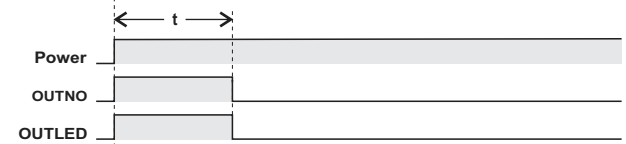

Mode C :
Initial periodic timig for
the relay's trigger

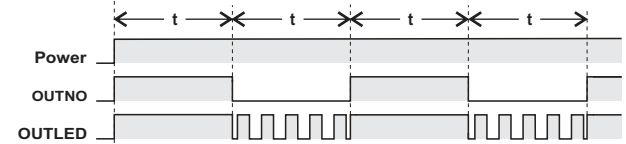

Mode D :
The relay's trigger for
periodic timing

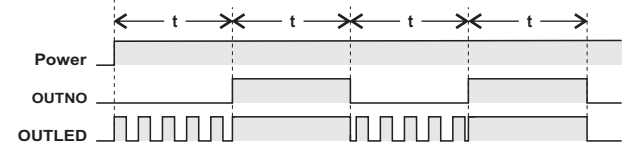

Mode E :
For the relay's trigger
single pulse delay timing

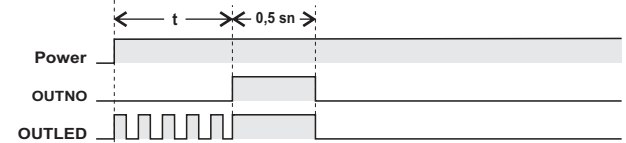

Mode F :
The relay's trigger for
periodic pulse timing

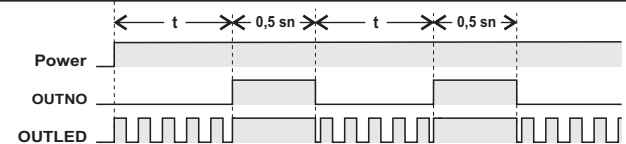

SİSEL MÜHENDİSLİK ELEKTRONİK SAN. VE TİC. A.Ş.
Sarıfelli Mah. Barbaros Cad. No:13 Y.Dudullu 34775
ÜMRANİYE/İSTANBUL-TÜRKİYE
Tel : +90 216 499 46 64 Pbx. Fax : +90 216 365 74 01
url : www.enda.com.tr



ATSP01-E-01-201411

CONNECTION DIAGRAM

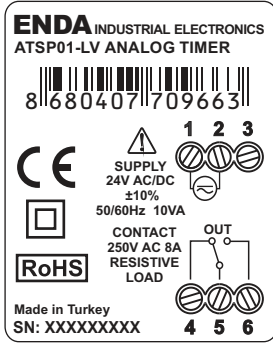
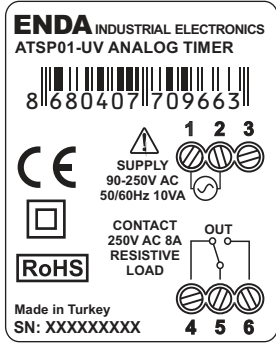

Logic output of the instrument is not electrically insulated from the internal circuits. Therefore, when using a grounding thermocouple, do not connect the logic output terminals to the ground.

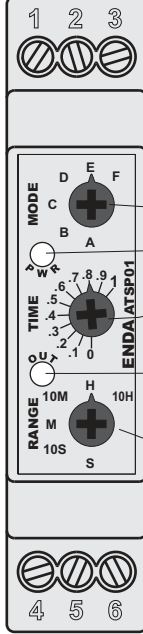
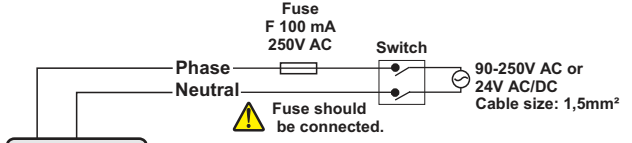

- 1) Mains supply cords shall meet the requirements of IEC 60227 or IEC 60245.
- 2) In accordance with the safety regulations, the power supply switch shall bring the identification of the relevant instrument and it should be easily accessible by the operator.



ENDA ATSP01 Series timers are rail mountable devices. Make sure that the device is used only for intended purpose. The shielding must be grounded on the instrument side. During an installation, all of the cables that are connected to the device must be free of energy. The device must be protected against

inadmissible humidity, vibrations, severe soiling and make sure that the operation temperature is not exceeded. All input and output lines that are not connected to the supply network must be laid out as shielded and twisted cables. These cables should not be close to the power cables or components. The installation and electrical connections must be carried on by a qualified staff and must be according to the relevant locally applicable regulations.



Equipment is protected throughout by
DOUBLE INSULATION



Holding screw
0.4-0.5Nm.

DIMENSIONS

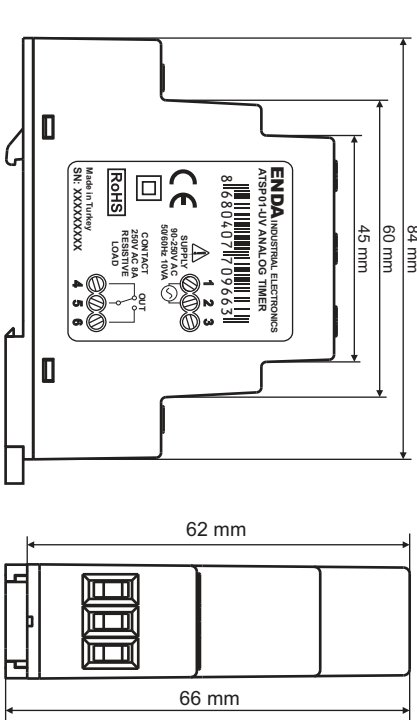

MONTAGE

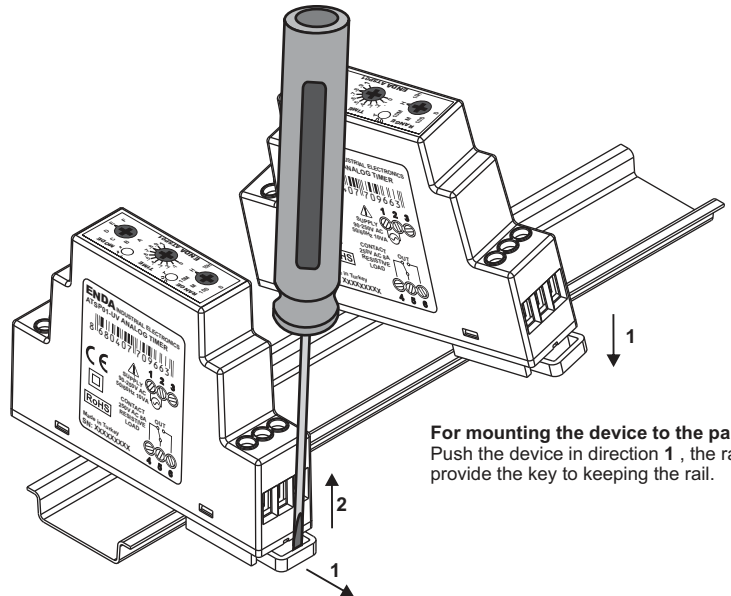

For mounting the device to the panel;
Push the device in direction 1 , the rails provide the key to keeping the rail.

For removing the device from rail;
Push the rail lock in direction 1 with a screwdriver and pull the device in direction 2 .