



Read the user manual carefully before using the device! The user is responsible for damages, losses, and accidents caused by not following the warnings in the user manual. In case of malfunctions resulting from this, the device will be out of warranty coverage.

ERC

Remote Monitoring Device

- Dimensions 96x96mm,
- 3.5" TFT Screen,
- On-Off control,
- Changeable IP address, NetMask, Gateway, and DNS,
- RS485 connection with changeable Baudrate,
- Connect up to 10 slave devices via RS485,
- Ability to add parameter queries for connected slave devices,
- CE marked according to EN standards.



ORDER CODE: ERC

Technical Specifications

Electrical Specifications

Supply Voltage	90-250V AC, 50/60Hz
Power Consumption	Maximum 7VA
Connection	Terminal of Power 2.5mm ² , Signal 1.5mm ²
EMC	EN 61326-1: 2021
Safety Requirements	EN 61010-1: 2010 (Pollution degree 2, overvoltage category II)

Environmental Specifications

Operating/Storage Temperature	0 ... +50°C / -25 ... 70°C
Relative Humidity	Operates at humidity up to 80% at 31°C, then decreases linearly and drops to 50% at 40°C
Protection Class	According to EN 60529 standard; Front panel: IP65, Rear panel: IP20
Altitude	Maximum 2000m



It should be used in environments free from flammable and corrosive gases.

Box

Mounting Type	Installed by compression onto the panel
Dimensions	W96xH96xD81mm
Weight	Approximately 400 grams
Enclosure Materials	Self-extinguishing plastics are used

⚠ The device should not be wiped with cleaning agents containing solvents (such as thinner, gasoline, acid, etc.) or abrasive cleaning agents

Connection Diagram



ENDA ERC is a panel type device. The device must be used in accordance with the instructions. There should be no electricity in the connection cables during installation. The device must be protected from moisture, vibration, and pollution. Attention should be paid to the operating temperature. Shielded and twisted cord cable should be used in input and output lines not connected to the grid. These cables should not pass near high power lines and devices. The screen line must be grounded from the device end. Installation and electrical connections must be made by technical personnel in accordance with the instructions in the user manual.



90 - 250V AC
50/60Hz, MAX. 7VA

ModBus
RS 485

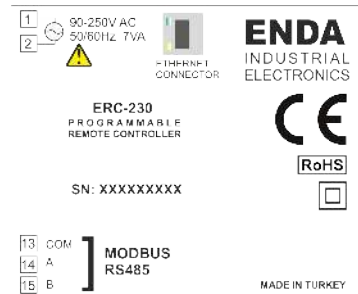
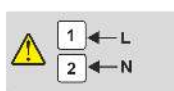
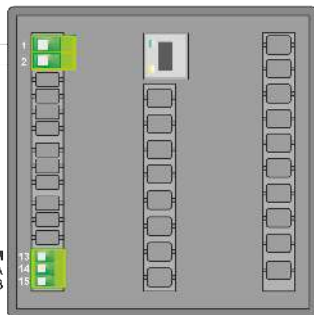

SUPPLY:

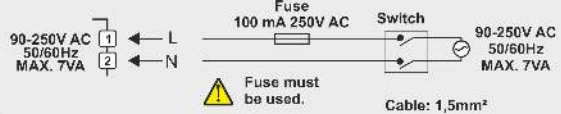

Tightening torque
0.4-0.5Nm



The entire device has
DOUBLE INSULATION

Note:

- 1- Supply cables must comply with the requirements of IEC 60277 or IEC 60245.
- 2- In accordance with safety regulations, the mains switch must be in a location easily accessible by the operator and must have a sign indicating its relevance to the device.

Dimensions and Installation

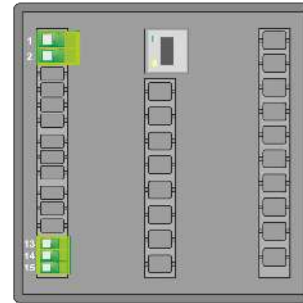
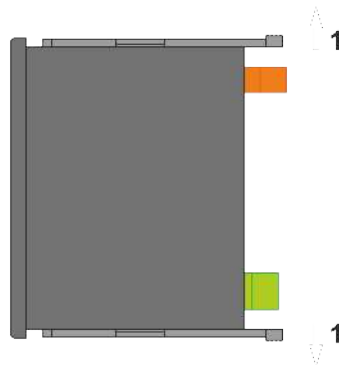

Panel Cut-Out

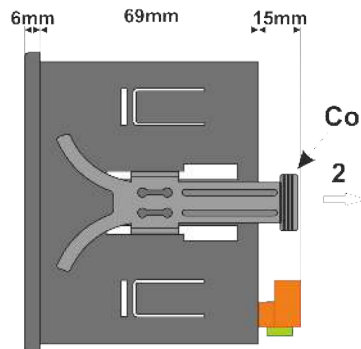
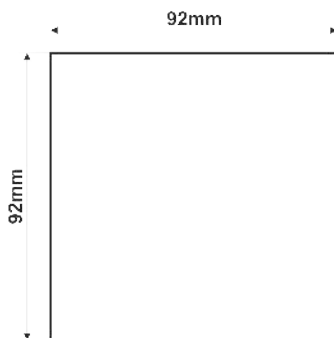

To remove the device from the panel:

- Stretch the compression fitting **1** in the direction of the arrow.
- Pull the fitting in the direction of arrow **2**.

Note:

- 1- The panel thickness must be maximum 10mm.
- 2- If there is less than 60mm clearance behind the device, it becomes difficult to remove from the panel.

Front Panel

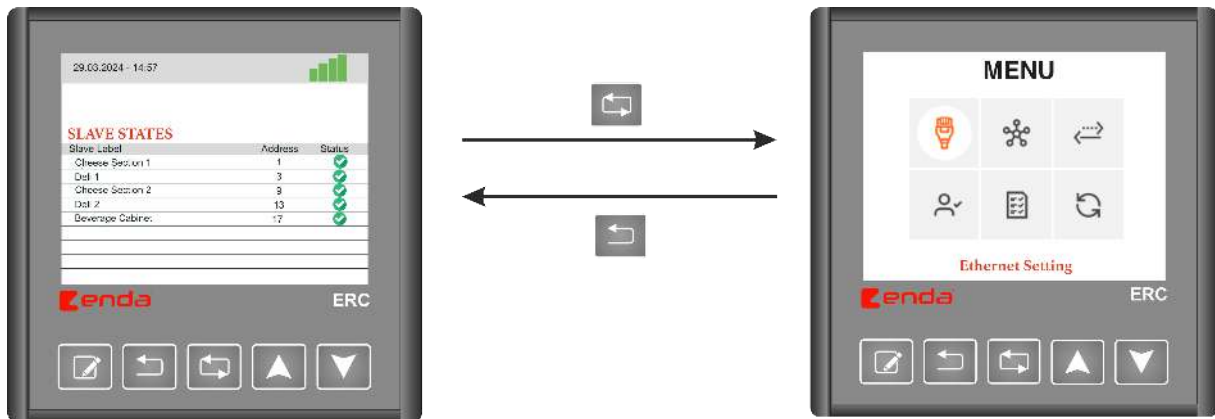

Menu and Button Definitions

	Enter "Menu Mode" and change parameter.
	Return to previous page in "Menu Mode" and exit parameter.
	Navigate between options in "Menu Mode".
	Increase value of selected parameter in "Menu Mode".
	Decrease value of selected parameter in "Menu Mode".
	Return to factory settings page.

Menu Definitions





	Page for entering IP, Netmask, Gateway, etc. addresses.
	Page for setting BaudRate and other communication settings.
	Page for pairing the ERC device with the server.
	Page showing authorized emails.
	Page showing tracked parameters.
	Update menu page.

Menu Button Usage

- While in "Main Screen", holding down for 2 seconds switches to "Menu Mode".
- While in "Menu Mode", pressing returns to "Main Screen".
- While in "Menu Mode", navigate between menus using .
- Press to enter selected menu.



Ethernet Page

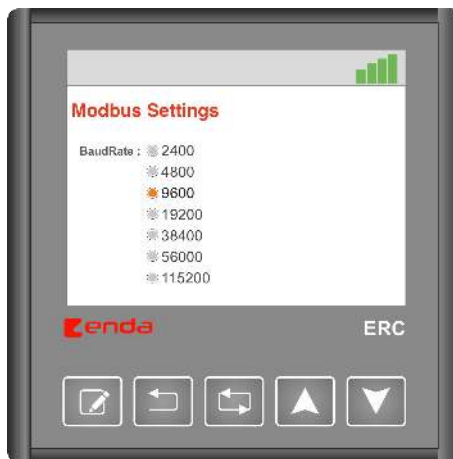

- Use  to switch between DHCP-STATIC mode.
- In STATIC IP mode, navigate between parameters using   buttons.
- Select parameter with , then change values using arrow buttons.

Modbus Page



- Use arrow buttons   to change Modbus RTU BaudRate. Return to menu with .

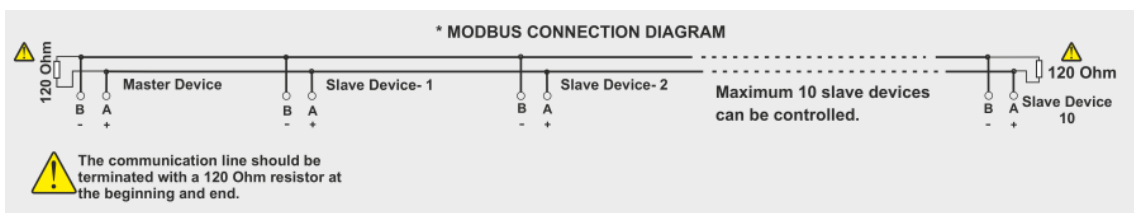

Pair Page



- To pair the server with the ERC device, open Pair Page and enter the 6-digit code shown on the screen into the designated field on the website. Press  to exit the page.



Authorized Emails Page



- Authorized emails can be viewed/deleted through this page.
- NOTE: After deleting authorized emails, the server and ERC device must be paired again to access the ERC device from the server.



Tracked Slave Devices



- Navigate between slave devices and parameters using arrow buttons  .
- **ID:** ID number of the connected slave device.
- **Reg Type:** Type of read register. Four different types of registers can be read: Input, Holding, Coil, Discrete.
- **Reg Num:** Address of the read register.
- **RAW DATA:** Value of the read register. If there is a problem with the reading, the message "FR" is displayed.





Update Page



- Upon entering the update page, please wait for the firmware list to be updated.
 - Once the firmware list is updated, navigate between files using arrow buttons  .
- Select the desired file with set .
- After the file download process starts, please wait for the download to complete and the firmware to be updated. Do not disconnect the device's internet connection or power during this time.

Status Bar and Error Definitions



Definitions	Description
 (1) Ethernet Status	Indicates whether the Ethernet cable is connected to the ERC device.
 (2) IP Status	Indicates whether the ERC device has obtained an IP.
 (3) Internet Status	Indicates whether the ERC device has an internet connection.
 (4) Server Connection Status	Indicates the server connection status of the ERC device.
 Slave Error Status	Indicates a connection error with the slave device connected to the ERC device.