

DIMENSIONS

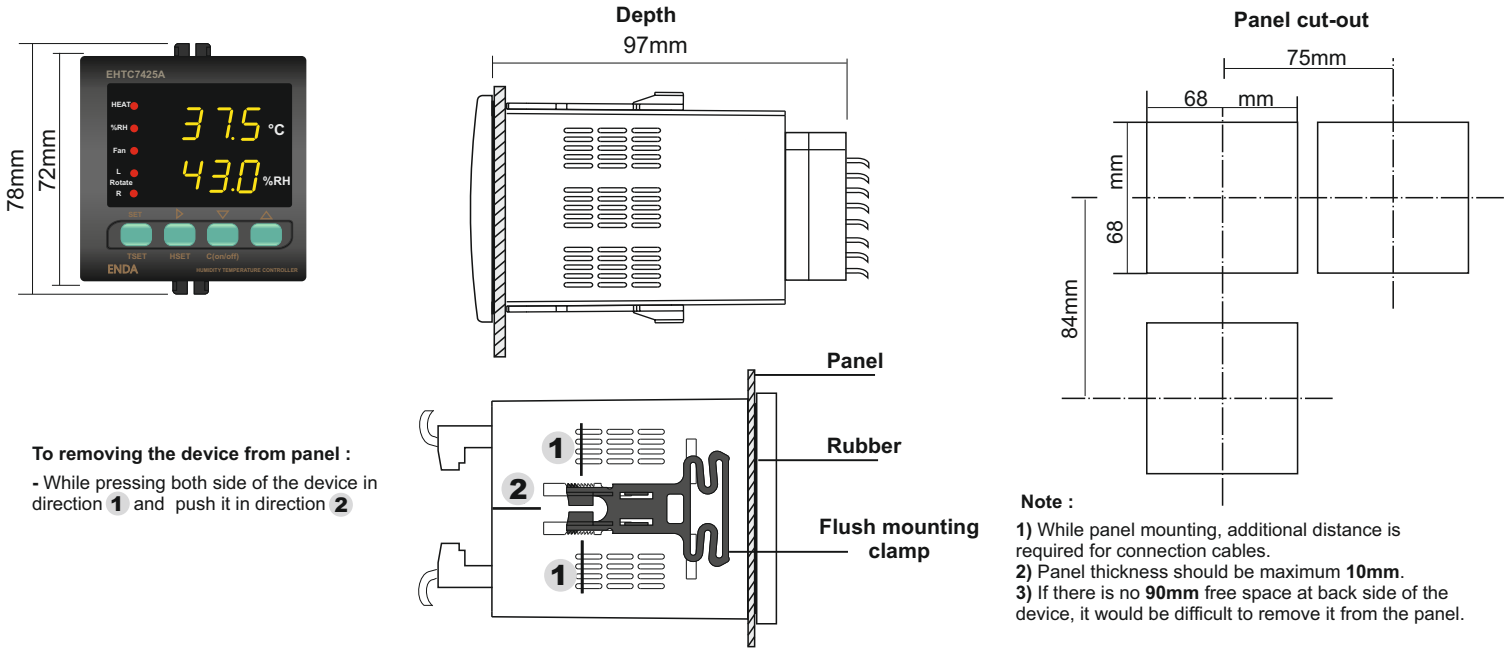

To removing the device from panel :
- While pressing both side of the device in direction **1** and push it in direction **2**

SENSOR (Must be ordered separately)

EHTD-CB-100 Digital Output Humidity Temperature Sensor

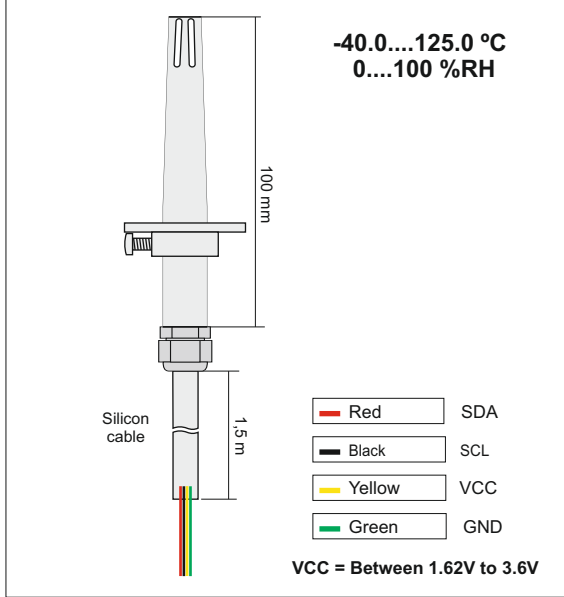

Sensor	Measuring Range	Device to be used
EHTD-CB-100	-40.0....125.0 °C 0....100 %RH	EHTC7425A-DS-XX
ESHT-102-W-XX ESHT-102-CB-XX ESHT-102-DC-XX	-40.0....125.0 °C 0....100 %RH	EHTC7425A-AS-XX
EHTS-W-230-XX EHTS-W-LV-XX EHTS-CB-230-XX EHTS-CB-LV-XX EHTS-DC-230-XX EHTS-DC-LV-XX		
EHTC-W-230-XX EHTC-W-LV-XX EHTC-CB-230-XX EHTC-CB-LV-XX EHTC-DC-230-XX EHTC-DC-LV-XX		

EHTD-CB-100 (Used with EHTC7425A-DS-XX)

For more detailed information about the sensor, you can review the sensor manual on our website.

INSTALLATION

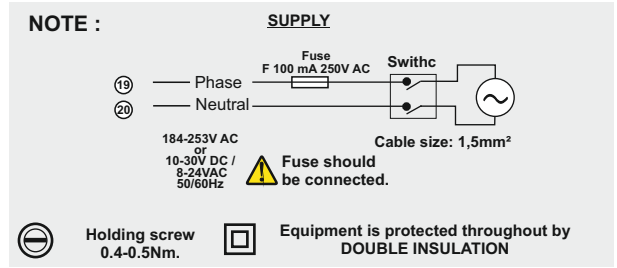
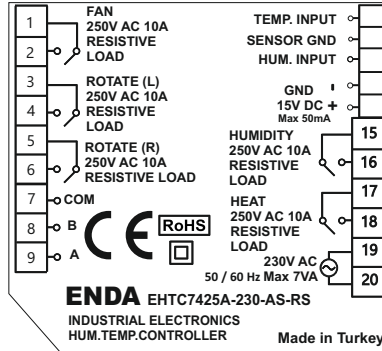
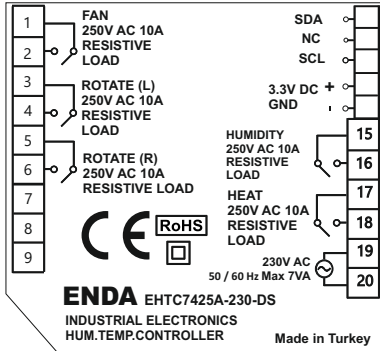

Note :

- 1) Mains supply cords shall meet the requirements of IEC 60227 or IEC 60245.
- 2) In accordance with the safety regulations, the power supply switch shall bring the identification of the relevant instrument and it should be easily accessible by the operator.



ENDA EHTC725A is intended for installation in control panels. Make sure that the device is used only for intended purpose. The shielding must be grounded on the instrument side. During an installation, all of then cables that are connected to the device must be free of energy. The device must be protected against inadmissible humidity, vibrations, severe soiling. Make sure that the operation temperature is not exceeded. All input and output lines that are not connected to the supply network must be laid out as shielded and twisted cables. These cables should not be close to the power cables or components. The installation and electrical connections must be carried on by a qualified staff and must be according to the relevant locally applicable regulations.

FRONT PANEL COMMANDS & USAGE

Indicator(s) LEDs illuminates if ;

- Heater relay is activated
- Humidity relay is activated
- Fan relay is activated
- Left relay (rotation) is activated
- Right relay (rotation) is activated

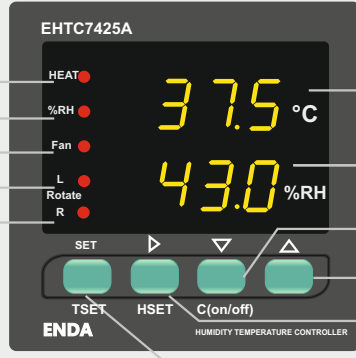

In "Running Mode", indicates the measured temperature value.
In "Programming Mode", indicates the parameter name.

In "Running Mode", indicates the measured relative humidity value.
In "Programming Mode", indicates the parameter value or unit.

In "Running Mode", switches off the control outputs.
In "Programming Mode", decrease the value or changes the parameters.

In "Running Mode", switches off the buzzer.
In "Programming Mode", increase the value or changes the parameters.

In "Running Mode", changes the humidity set value.

In "Running Mode", changes the temperature set value.
In "Programming Mode", indicates the parameter value.

Displaying and Changing Temperature Set Values

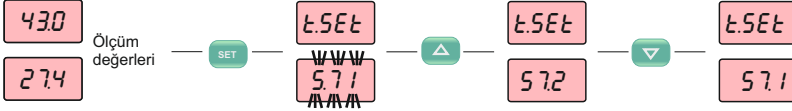

During "Running Mode", if **SET** key is preset, temperature setpoint value flashes for 3 seconds. While flashing, by pressing **▲** and **▼** keys, temperature value can be changed. If no key is pressed for 3 seconds or if one of the set keys is pressed again, adjusted set value is saved and the "Running Mode" is entered.

Displaying and Changing Humidity Set Values

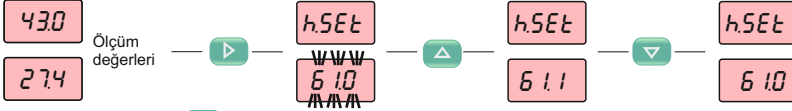

During "Running Mode", if **▶** key is preset, humidity setpoint value flashes for 3 seconds. While flashing, by pressing **▲** and **▼** keys, humidity set value can be changed. If no key is pressed for 3 seconds or if one of the set keys is pressed again, adjusted set value is saved and the "Running Mode" is entered.

Locking & Unlocking Keypad

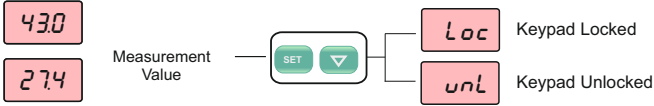

During "Running Mode", if **SET** and **▼** keys are pressed together for 2 seconds, **Loc** message is displayed and the keypad locked. While keypad is locked, if **SET** and **▼** keys are pressed together for 2 seconds, **unL** message is displayed and the keypad unlocked and "Running Mode" is entered. While keypad is locked, if one of the key is pressed, **Loc** message is displayed. During keypad locked, temperature and humidity set values can be displayed but can not be changed.

Activating / Deactivating Control Outputs

During "Running Mode", if **▼** key is pressed for 2 seconds, **Ed 15** message displayed and the control outputs become deactivated and device works as an indicator. While control outputs deactivated, by pressing **▼** key for 2 seconds, **CEnb** message displayed and device continues to control functions.

Stopping Buzzer Alarm

When an alarm condition occurs, an audible alarm is triggered. By pressing, **▲** key, buzzer alarm can be turned off.

Default Settings

Powered on device by pressing **▼** key, **dPRr** message appears on display and device reset to default settings.

Displaying Revision Number

If **SET** **▲** **▼** keys are pressed together in "Running Mode", revision number **r.001** appears on display.

ROTATION OUTPUT GRAPHICS

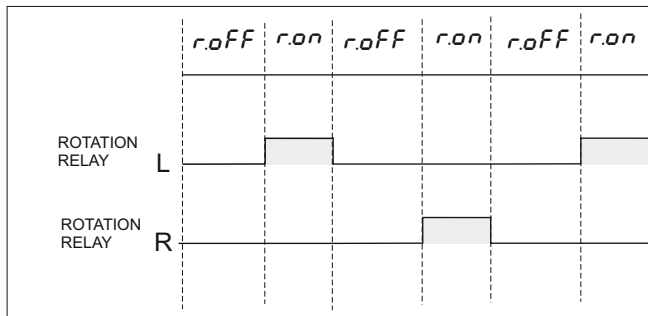

(*) Rotation process runs sequentially for left and right directions, Rotation process runs consecutively as opened until open duration time(**r.on**)and closed until close duration time (**r.off**)

Error - Warning - Alarm Definitions

5.Err A.A.A	Sensor Failure. Check the sensor connection. The audible warning is activated. Temperature and humidification outputs are disabled.
24.7 A.A.A	Temperature Alarm. Audible warning is activated. Current temperature flashes. Outputs are disabled when the upper limit is exceeded.
61.1 A.A.A	Humidification Alarm. Audible warning is activated. Current humidity flashes. Outputs are disabled when the upper limit is exceeded.
5.tun A.A.A	Self tune menu has been entered.
t.hi A.A.A	During self tune menu, indicates that the measured temperature value is greater than 60% of the set value.
run A.A.A	Self tune process is running.
5ucc A.A.A	Self tune process has been successfully completed.



SELF TUNE OPERATION

i In order to start the Self-tune operation, *tPid* parameter must be set to *YES*.

Running Mode





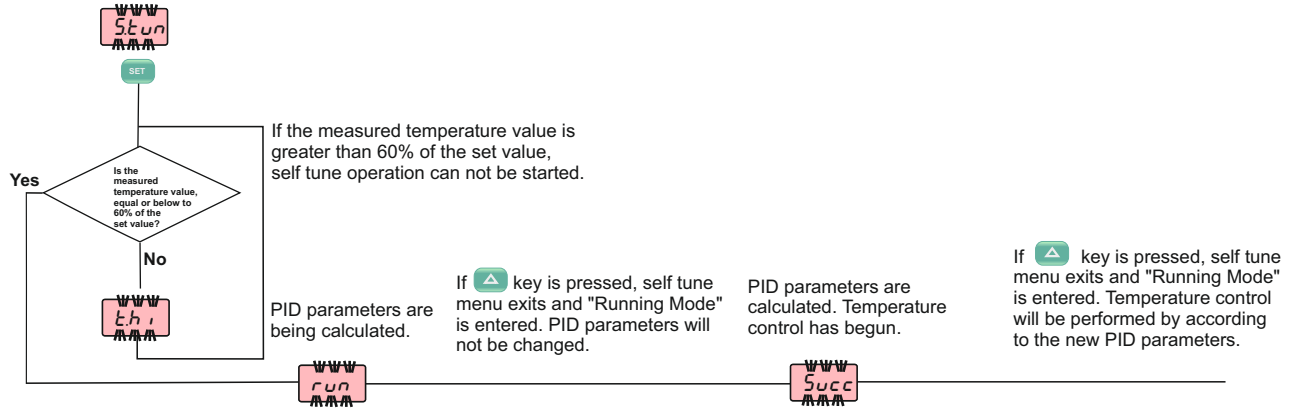

L P 1 7





If the  key is pressed for 7 seconds while in user menu, self tune menu is entered. Then  key is pressed, if the conditions are suitable, self tune process starts. This menu can be exited by pressing any key.



PROGRAMMING THE DEVICE (1/2)



Device has two menus as user and hidden menu. User menu is the frequently used parameters and the hidden menu is where all parameters are found. Menus can be transferred between parameters. If  and  keys are pressed together for 2 seconds in the hidden menu, the parameter is transferred to the user menu. Up to 10 parameters can be transferred to the user menu in this way. If  and  keys are pressed together for 2 seconds in the user menu, parameter is removed from user menu.























User Menu

If  and  keys are pressed together for 2 seconds, user menu is entered and first parameter in the user menu is displayed. If no operation is performed for 7 seconds or when   keys are pressed together, "Running Mode" is entered.



Programming Mode

Hidden Menu

If  key is pressed for 7 seconds while in user menu, hidden menu is entered and then the first parameter in the hidden menu is displayed. All parameters in the PARAMETER LIST on page 5 can be accessed from this menu. The parameter access and save functions are as in the user menu. If no operation is performed for 7 seconds, or if the   keys are pressed together, "Running Mode" is entered.





















-  **LP17** Hidden Menu
-  **dPnt** Decimal point display
-  **Snd** Buzzer (*no*:Buzzer not active. *YES*: Buzzer active)
-  **t.inP** Temperature, Humidity output type
(*0-20*:0~20mA, *4-20*:4~20mA, *0-10*:0~10V, *1-5*:1~5V)
- **  **t.UPL** Temperature set value Upper Limit
- **  **t.LoL** Temperature set value Lower Limit
-  **t.HYS** Temperature hysteresis
-  **t.oFF** Temperature offset value
-  **t.cnt** Temperature control.
Lo : Output is active when the temperature is below set value (cooling control),
Hi : The output is active when the temperature is above the set value (heating control).
-  **t.Pon** Temperature output delay time after power-up
-  **t.Pid** PID temperature control selection (*no*:On-Off control *YES*: PID control)
-  **t.Pb** Proportional band for PID control.
-  **t.ti** Integral time for PID control
-  **t.td** Derivation time for PID control.
-  **t.PcP** Periodic time for PID control
- **  **h.inP** Temperature, Humidity input type.
0-20:0~20mA, *4-20*:4~20mA, *0-10*:0~10V, *1-5*:1~5V
- **  **h.UPL** Humidity set value Upper Limit.
- **  **h.LoL** Humidity set value Lower Limit
-  **h.HYS** Humidity hysteresis
-  **h.oFF** Humidity offset value
-  **h.cnt** Humidification control.
Lo:Output is active when the humidity is below set value (cooling control),
Hi : The output is active when the humidification is above the set value (heating control).
-  **h.Pon** Humidification output delay time after power-up
-  **F.cnt** Fan Control
no: Fan not active, *YES*: Fan active

LP27

-  **Unit** Temperature unit
-  **AdrS** Slave device address selection.
-  **bAud** Communication speed (baud rate) selection

Note: When the **LP27** menu is opened, the parameters of the **LP17** menu also appear.

**** The marked parameters are valid only for the humidity temperature sensor model with analogue input.**

-  **FtYP** Fan output type selection (*t nE*: The fan runs at time-dependent., *tEnP*: The fan runs at temperature-dependent.)
-  **FStA** Fan temperature control
(*Lo*: The fan will be activated when the temperature value below the setpoint., *YEs*: The fan will be activated when the temperature value above the setpoint).
-  **FSEt** Fan setpoint value.
-  **FHYs** Fan hysteresis value.
-  **FtSP** Fan alarm setpoint value.
-  **FHYs** Fan alarm hysteresis.
-  **Fon** Fan ON time duration.
-  **Foff** Fan OFF time duration.
-  **rCnt** Rotating Control (*no*: Rotating not active, *YEs*: Rotating active)
-  **r.on** Rotating ON time duration
-  **r.off** Rotating OFF time duration.
-  **RPon** Alarm message display delay time after power up
-  **RtEP** Temperature alarm configuration (*AbS*: Absolute alarm, *rEF*: Relative alarm)
AbS: Alarm values are *RtLo* and *RtH*,
rEF: Alarm values are $RtLo = tSEt - RtLo$ and $RtH = tSEt + RtH$,
-  **RtH** Temperature upper level alarm (If *RtEP* is changed, this parameter must be re-programmed).
-  **RtLo** Temperature lower level alarm (If *RtEP* is changed, this parameter must be re-programmed)
-  **RtHS** Temperature alarm hysteresis
-  **RhtP** Humidity alarm configuration (*AbS*: Absolute alarm, *rEF*: Relative alarm)
AbS: Alarm values are *RhLo* and *RhH*,
rEF: Alarm values are $RhLo = tSEt - RhLo$ and $RhH = hSEt + RhH$,
-  **RhH** Humidity upper level alarm. (If *RhtP* is changed, this parameter must be re-programmed)
-  **RhLo** Humidity lower level alarm.(If *RhtP* is changed, this parameter must be re-programmed)
-  **RhHS** Humidity alarm hysteresis.

MODBUS CONNECTION

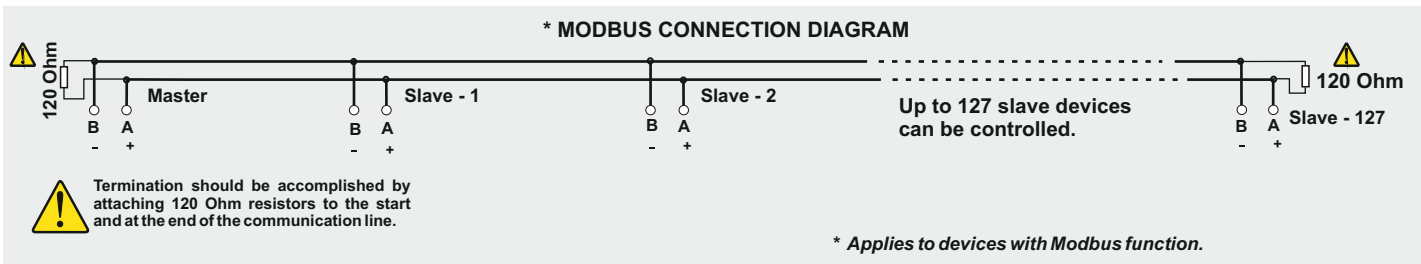

PARAMETER LIST

CONFIGURATION PARAMETERS		Minimum	Maximum	Unit Type	Default
<i>UnIt</i>	Temperature unit OFF= <i>oC</i> , ON= <i>oF</i>	<i>oC</i>	<i>oF</i>		<i>oC</i>
<i>dPnIt</i>	Decimal indication OFF= <i>no</i> , ON= <i>YES</i>	<i>no</i>	<i>YES</i>		<i>no</i>
<i>Snd</i>	Buzzer OFF= <i>no</i> , ON= <i>YES</i>	<i>no</i>	<i>YES</i>		<i>no</i>
TEMPERATURE CONTROL PARAMETERS					
<i>t.inP</i>	Temperature, input type (<i>0-20</i> :0~20mA, <i>4-20</i> :4~20mA, <i>0-10</i> :0~10V, <i>1-5</i> :1~5V) Only available in humidity temperature sensor models with analog output.	<i>0-20</i>	<i>1-5</i>	mA / V	<i>0-20</i>
<i>t.uPL</i>	Temperature Upper Limit. Only available in humidity temperature sensor models with analog output.	<i>tLoL</i>	<i>125</i>	°C / °F	<i>60</i>
<i>t.LoL</i>	Temperature Lower Limit. Only available in humidity temperature sensor models with analog output.	<i>-40</i>	<i>t.uPL</i>	°C / °F	<i>-40</i>
<i>t.HYS</i>	Temperature hysteresis	<i>1</i>	<i>20</i>	°C / °F	<i>2</i>
<i>t.oFF</i>	Temperature ofset value	<i>-20</i>	<i>20</i>	°C / °F	<i>0</i>
<i>t.cnIt</i>	Temperature control. <i>Lo</i> :Output is active when the temperature is below set value (cooling control), <i>Hi</i> : The output is active when the temperature is above the set value (heating control).	<i>Lo</i>	<i>Hi</i>		<i>Hi</i>
<i>t.Pon</i>	Temperature output delay time after power-up	<i>00:00</i>	<i>99:00</i>	min:sec	<i>1:00</i>
<i>t.Pid</i>	PID temperature control selection (<i>no</i> :On-Off control <i>YES</i> : PID control)	<i>no</i>	<i>YES</i>		<i>no</i>
<i>t.Pb</i>	Proportional band for PID control	<i>0</i>	<i>100</i>	%	<i>14</i>
<i>t.ti</i>	Integral time for PID control	<i>00:00</i>	<i>99:00</i>	min:sec	<i>1:56</i>
<i>t.td</i>	Derivation time for PID control.	<i>00:00</i>	<i>99:00</i>	min:sec	<i>0:35</i>
<i>t.PcP</i>	Periodic time for PID control	<i>00:00</i>	<i>02:00</i>	min:sec	<i>0:20</i>
HUMIDIFICATION CONTROL PARAMETERS					
<i>h.inP</i>	Humidity input type (<i>0-20</i> :0~20mA, <i>4-20</i> :4~20mA, <i>0-10</i> :0~10V, <i>1-5</i> :1~5V) Only available in humidity temperature sensor models with analog output.	<i>0-20</i>	<i>1-5</i>	mA / V	<i>0-20</i>
<i>h.uPL</i>	Humidity Upper Limit. Only available in humidity temperature sensor models with analog output.	<i>hLoL</i>	<i>100</i>	%RH	<i>100</i>
<i>h.LoL</i>	Humidity Lower Limit. Only available in humidity temperature sensor models with analog output.	<i>0</i>	<i>h.uPL</i>	%RH	<i>0</i>
<i>h.HYS</i>	Humidity hysteresis	<i>1</i>	<i>20</i>	%RH	<i>2</i>
<i>h.oFF</i>	Humidity ofset value	<i>-20</i>	<i>20</i>	%RH	<i>0</i>
<i>h.cnIt</i>	Humidification control. <i>Lo</i> :Output is active when the humidity is below set value (cooling control), <i>Hi</i> : The output is active when the humidification is above the set value (heating control).	<i>Lo</i>	<i>Hi</i>		<i>Hi</i>
<i>h.Pon</i>	Humidification output delay time after power-up	<i>00:00</i>	<i>99:00</i>	min:sec	<i>1:00</i>
FAN CONTROL PARAMETERS					
<i>F.cnIt</i>	Fan Control (<i>no</i> : Fan not active, <i>YES</i> : Fan active)	<i>no</i>	<i>YES</i>		<i>YES</i>
<i>F.tYP</i>	Fan output type selection (<i>t.nE</i> : The fan runs at time-dependent., <i>t.E.nP</i> : The fan runs at temperature-dependent.)	<i>t.nE</i>	<i>t.E.nP</i>		<i>t.E.nP</i>
<i>F.SEt</i>	Fan setpoint value	<i>-40</i>	<i>125</i>	°C / °F	<i>38</i>
<i>F.StA</i>	Fan temperature control (<i>Lo</i> : The fan will be activated when the temperature value below the setpoint. , <i>YES</i> : The fan will be activated when the temperature value above the setpoint).	<i>Lo</i>	<i>Hi</i>		<i>Hi</i>
<i>F.HYS</i>	Fan hysteresis value	<i>1</i>	<i>20</i>	°C / °F	<i>1</i>
<i>F.on</i>	Fan ON time duration.	<i>00:00</i>	<i>99:00</i>	hr:min	<i>1:00</i>
<i>F.oFF</i>	Fan OFF time duration.	<i>00:00</i>	<i>99:00</i>	hr:min	<i>1:00</i>
<i>F.tSP</i>	Fan alarm setpoint value.	<i>tLoL</i>	<i>t.uPL</i>	°C / °F	<i>50</i>
<i>F.RHS</i>	Fan alarm hysteresis.	<i>1</i>	<i>20</i>	°C / °F	<i>2</i>
RIGHT - LEFT Rotating CONTROL PARAMETERS					
<i>r.cnIt</i>	Rotating Control (<i>no</i> : Rotating not active, <i>YES</i> : Rotating active)	<i>no</i>	<i>YES</i>		<i>YES</i>
<i>r.on</i>	Rotating ON time duration.	<i>00:00</i>	<i>99:00</i>	min:sec	<i>1:00</i>
<i>r.oFF</i>	Rotating OFF time duration.	<i>00:00</i>	<i>99:00</i>	hr:min	<i>1:00</i>
ALARM PARAMETERS					
<i>RP.on</i>	Alarm message display delay time after power up	<i>00:00</i>	<i>99:00</i>	min:sec	<i>1:00</i>
<i>REtP</i>	Temperature alarm configuration (<i>AbS</i> : Absolute alarm, <i>rEF</i> : Relative alarm) <i>AbS</i> : Alarm values are <i>REtLo</i> and <i>REtHi</i> , <i>rEF</i> : Alarm values are <i>REtLo</i> = <i>t.SEt-REtLo</i> and <i>REtHi</i> , = <i>t.SEt+REtHi</i> ,	<i>AbS</i>	<i>rEF</i>		<i>AbS</i>
<i>REtHi</i>	Temperature upper level alarm (If <i>REtP</i> is changed, this parameter must be re-programmed).	<i>REtLo</i>	<i>125</i>	°C / °F	<i>125</i>
<i>REtLo</i>	Temperature lower level alarm (If <i>REtP</i> is changed, this parameter must be re-programmed)	<i>-40</i>	<i>REtHi</i>	°C / °F	<i>-40</i>
<i>REtHS</i>	Temperature alarm hysteresis	<i>1</i>	<i>20</i>	°C / °F	<i>2</i>
<i>RhEtP</i>	Humidity alarm configuration (<i>AbS</i> : Absolute alarm, <i>rEF</i> : Relative alarm) <i>AbS</i> : Alarm values are <i>RhLo</i> and <i>RhHi</i> , <i>rEF</i> : Alarm values are <i>RhLo</i> = <i>t.SEt-RhLo</i> and <i>RhHi</i> , = <i>h.SEt+RhHi</i> ,	<i>AbS</i>	<i>rEF</i>		<i>AbS</i>
<i>RhHi</i>	Humidity upper level alarm. (If <i>RhEtP</i> is changed, this parameter must be re-programmed)	<i>RhLo</i>	<i>100</i>	%RH	<i>100</i>
<i>RhLo</i>	Humidity lower level alarm.(If <i>RhEtP</i> is changed, this parameter must be re-programmed)	<i>0</i>	<i>RhHi</i>	%RH	<i>0</i>
<i>RhHS</i>	Humidity alarm hysteresis.	<i>1</i>	<i>20</i>	%RH	<i>2</i>
MODBUS COMMUNICATION PARAMETERS					
<i>AdrS</i>	Slave device address selection	<i>1</i>	<i>247</i>		<i>1</i>
<i>bRud</i>	Communication speed (baud rate) selection	<i>oFF</i>	<i>1920</i>	Bps	<i>9600</i>

ENDA EHTC7425A HUMIDITY AND TEMPERATURE CONTROLLER MODBUS ADDRESS MAP

1.1 HOLDING REGISTERS

Holding Register Addresses		Data Type	Data Content	Parameter Name	Read / Write Permission
Decimal	Hex				
0000d	0x0000	word	Temperature set value	<i>tSEt</i>	R / W
0001d	0x0001	word	Temperature set value Upper Limit	<i>t.uPL</i>	R / W
0002d	0x0002	word	Temperature set value Lower Limit	<i>tLoL</i>	R / W
0003d	0x0003	word	Temperature upper level alarm	<i>ALH ,</i>	R / W
0004d	0x0004	word	Temperature lower level alarm	<i>ALLo</i>	R / W
0005d	0x0005	word	Temperature hysteresis	<i>t.HYS</i>	R / W
0006d	0x0006	word	Temperature ofset value	<i>t.oFF</i>	R / W
0007d	0x0007	word	Temperature alarm hysteresis	<i>ALHS</i>	R / W
0008d	0x0008	word	Humidity set value	<i>hSEt</i>	R / W
0009d	0x0009	word	Humidity set value Upper Limit	<i>h.uPL</i>	R / W
0010d	0x000A	word	Humidity set value Lower Limit	<i>hLoL</i>	R / W
0011d	0x000B	word	Humidity hysteresis	<i>h.HYS</i>	R / W
0012d	0x000C	word	Humidity ofset value	<i>h.oFF</i>	R / W
0013d	0x000D	word	Humidity upper level alarm	<i>ALH ,</i>	R / W
0014d	0x000E	word	Humidity lower level alarm	<i>ALLo</i>	R / W
0015d	0x000F	word	Humidity alarm hysteresis	<i>ALHS</i>	R / W
0016d	0x0010	word	Temperature output delay time after power-up	<i>t.Pon</i>	R / W
0017d	0x0011	word	Humidity output delay time after power-up	<i>h.Pon</i>	R / W
0018d	0x0012	word	Fan setpoint value.	<i>FSEt</i>	R / W
0019d	0x0013	word	Fan hysteresis.	<i>FHYS</i>	R / W
0020d	0x0014	word	Fan alarm setpoint value.	<i>FtSP</i>	R / W
0021d	0x0015	word	Fan alarm hysteresis.	<i>FALHS</i>	R / W
0022d	0x0016	word	Fan ON time duration.	<i>F.on</i>	R / W
0023d	0x0017	word	Fan OFF time duration.	<i>F.oFF</i>	R / W
0024d	0x0018	word	Rotating ON time duration.	<i>r.on</i>	R / W
0025d	0x0019	word	Rotating OFF time duration..	<i>r.oFF</i>	R / W
0026d	0x001A	word	Alarm message display delay time after power-up	<i>APon</i>	R / W
0027d	0x001B	word	Integral time for PID control	<i>t.t ,</i>	R / W
0028d	0x001C	word	Derivation time for PID control.	<i>t.td</i>	R / W
0029d	0x001D	word	Temperature input type (0:0-20, 1:4-20, 2:0- 10, 3: 1-5)	<i>t.inP</i>	R / W
0030d	0x001E	word	Humidity input type (0:0-20, 1:4-20, 2:0- 10, 3: 1-5)	<i>h.inP</i>	R / W
0031d	0x001F	word	Proportional band for PID control	<i>t.Pb</i>	R / W
0032d	0x002A	word	Periodic time for PID control	<i>t.PcP</i>	R / W
0033d	0x0021	word	Address selction for slave device.	<i>AdrS</i>	R / W
0034d	0x0022	word	Baud Rate	<i>bAud</i>	R / W

1.2 INPUT REGISTERS

Input Register Addresses		Data Type	Data Content	Parameter Name	Read /Write Permisson
Decimal	Hex				
0000d	0x0000	word	Measured temperature value (°C / °F)	--	R
0001d	0x0001	word	Measured humidity value (%RH)	--	R

* Holding and Input Register parameters of type integer, those "signed integer" is defined as the decimal port of and associated with these parameters. (So,"14.0" is a parameter value of "140" will be read in). Relevant parameters for a period of "mm:ss" type ones in seconds, "hh:mm" while those species defined in minutes.

1.3 COILS

Coil Addresses		Data Type	Data Content	Parameter Name	Read /Write Permisson
Decimal	Hex				
00d	0x00	bit	Temperature unit OFF= <i>oC</i> , ON= <i>oF</i>	<i>Unit</i>	R / W
01d	0x01	bit	Decimal indication OFF= <i>no</i> , ON= <i>YES</i>	<i>dPnt</i>	R / W
02d	0x02	bit	Buzzer OFF= <i>no</i> , ON= <i>YES</i>	<i>Snd</i>	R / W
03d	0x03	bit	Temperature control OFF = <i>Lo</i> , ON = Relative alarm <i>H ,</i>	<i>t.cnL</i>	R / W
04d	0x04	bit	Humidity control OFF = <i>Lo</i> , ON = Relative alarm <i>H ,</i>	<i>h.cnL</i>	R / W
05d	0x05	bit	Fan Control (<i>no</i> : Fan not active, <i>YES</i> : Fan active)	<i>F.cnL</i>	R / W
06d	0x06	bit	Fan output type selection (OFF = timE . ON = tEmp)	<i>FtYP</i>	R / W
07d	0x07	bit	Fan temperature control (OFF = Lo , ON = Hi)	<i>FStR</i>	R / W
08d	0x08	bit	Rotating Control (<i>no</i> : Rotating not active, <i>YES</i> : Rotating active)	<i>r.cnL</i>	R / W
09d	0x09	bit	Temperature alarm configuration OFF = <i>AbS</i> ON = Relative alarm <i>rEF</i>	<i>ALtP</i>	R / W
010d	0x0A	bit	Humidity alarm configuration OFF = <i>AbS</i> , ON = Relative alarm <i>rEF</i>	<i>ALhP</i>	R / W
011d	0x0B	bit	PID temperature control selection OFF = <i>YES</i> , ON = <i>no</i>	<i>t.Pid</i>	R / W

1.4 DISCRATE INPUTS

Discrete Inputs Addresses		Data Type	Data Content	Parameter Name	Read /Write Permisson
Decimal	Hex				
0000d	0x0000	bit	Temperature relay output status (0=OFF; 1=ON)	--	R
0001d	0x0001	bit	Humidification relay output status (0=OFF; 1=ON)	--	R
0002d	0x0002	bit	Fan relay output status (0=OFF; 1=ON)	--	R
0003d	0x0003	bit	Right Rotating relay output status (0=OFF; 1=ON)	--	R
0004d	0x0004	bit	Left Rotating relay output status (0=OFF; 1=ON)	--	R

