

# ENDA ETS Series Rail and Panel Mounted Heat Sinks

Thank you for choosing ENDA products.

ETS series rail and panel mounted heat sinks are designed for EPxA1 and EPxA3 series Panel Mounted Solid State Relays.



## ORDER CODE

**ETS-62-100F**

|                           |     |              |     |
|---------------------------|-----|--------------|-----|
| <b>Product Basic Code</b> |     | <b>Fan</b>   |     |
| Heat-sink                 | ETS | Fan          | F   |
| <b>Width</b>              |     | <b>Depth</b> |     |
| 46mm                      | 46  | 62mm         | 62  |
| 62mm                      | 62  | 80mm         | 80  |
| 99mm                      | 99  | 100mm        | 100 |

## ENDA ETS-46-100 RAIL MOUNTED HEAT SINK

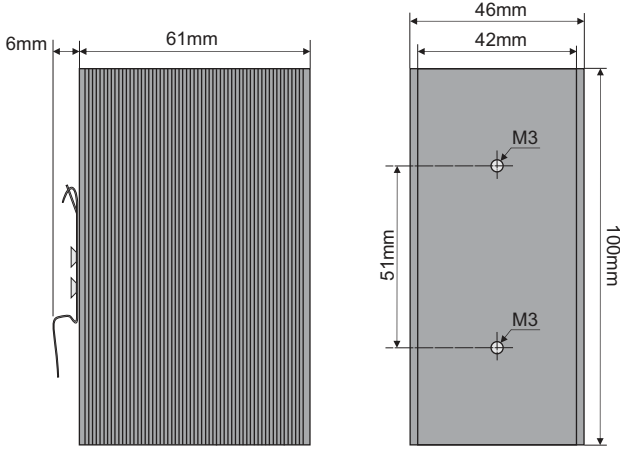

## ENDA ETS-46-80

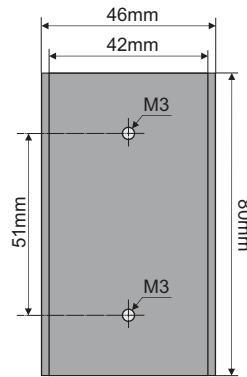

## ENDA ETS-46-62

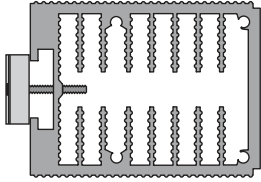
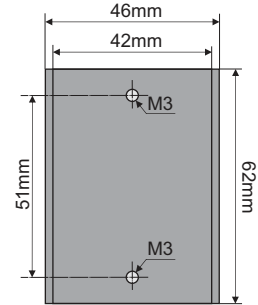

- For removing the device from the panel; Pull up in direction 1
- For mounting the device to the panel; Push down in direction 2

## ENDA ETS-46-100F RAIL MOUNTED HEAT SINK

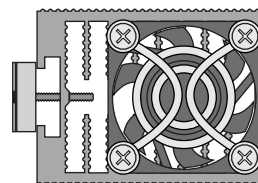
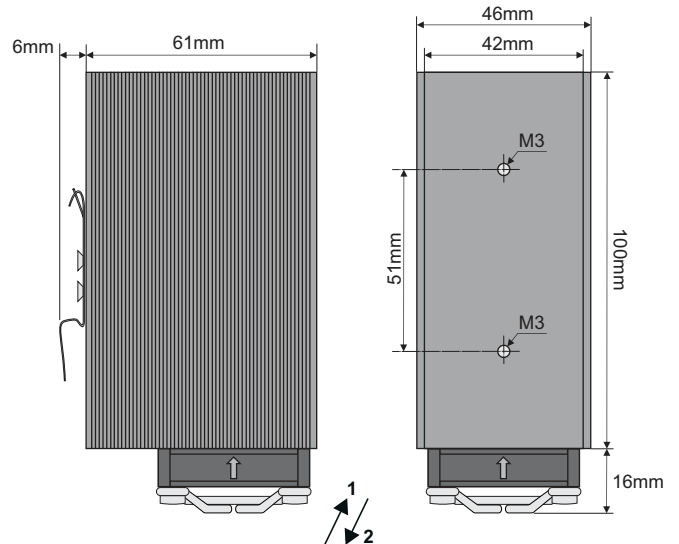

- For removing the device from the panel; Pull up in direction 1
- For mounting the device to the panel; Push down in direction 2

Fan supply : 24VDC, 100mA.  
Fan side of the device must be at the bottom.

| Heat Sink   | SSR Current (A) | Dimensions WxHxD (mm) | Thermal Resistance (°C/W) |
|-------------|-----------------|-----------------------|---------------------------|
| ETS-46-62   | 12-25           | 46x61x62              | 2,0                       |
| ETS-46-80   | 20-25           | 46x61x80              | 1,7                       |
| ETS-46-100  | 25-40           | 46x61x100             | 1,5                       |
| ETS-62-100  | 40-50           | 62x77x100             | 1,0                       |
| ETS-99-100  | 3x25            | 99x87x100             | 0,75                      |
| ETS-46-100F | 50-70           | 46x61x110             | 0,7                       |
| ETS-62-100F | 70-120          | 62x77x120             | 0,4                       |
| ETS-99-100F | 3x40 - 3x50     | 99x87x125             | 0,34                      |



**SİSEL MÜHENDİSLİK ELEKTRONİK SAN. VE TİC. A.Ş.**  
Şerifali Mah. Barbaros Cad. No:18 Y.Dudullu 34775  
ÜMRANIYE/İSTANBUL-TURKEY  
Tel : +90 216 499 46 64 Pbx. Fax : +90 216 365 74 01  
url : www.enda.com.tr



### ENDA ETS-62-100F RAIL AND PANEL MOUNTED HEAT SINK

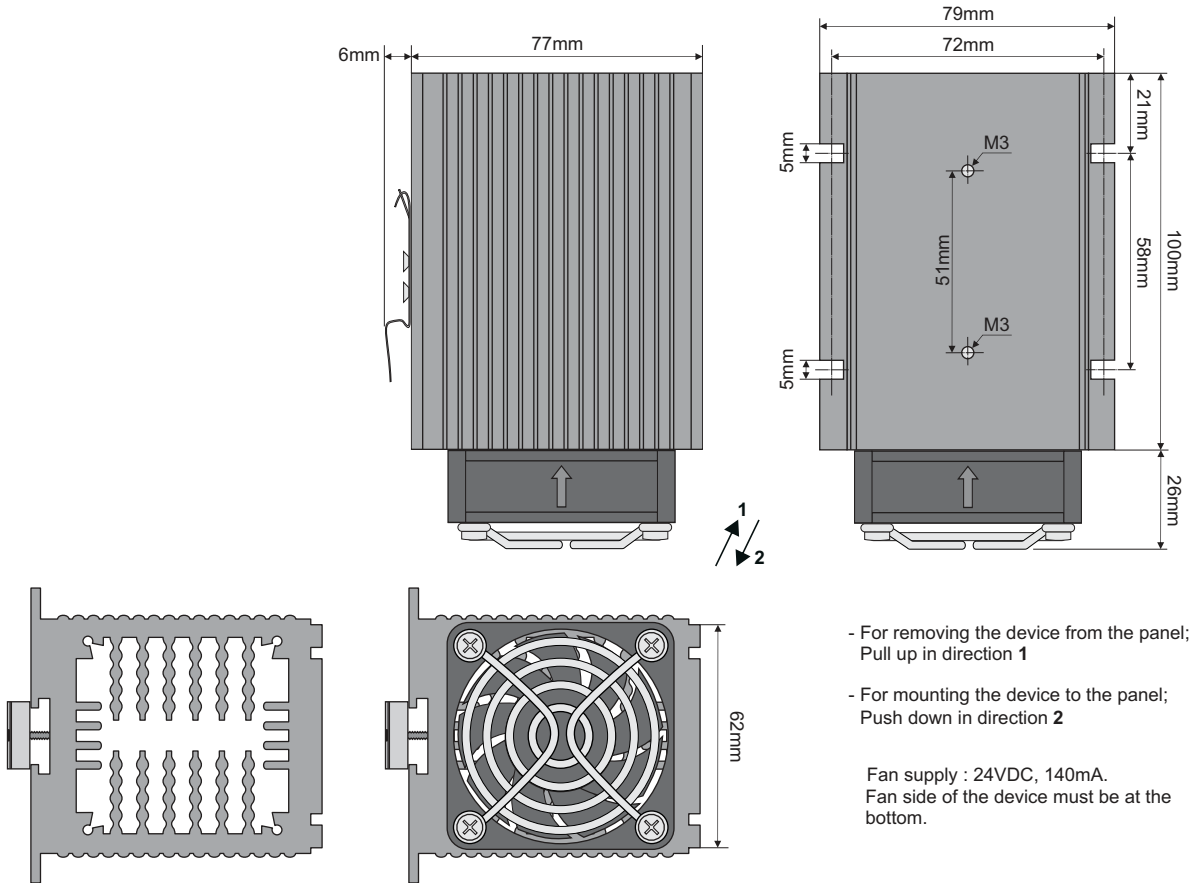

### ENDA ETS-99-100F RAIL AND PANEL MOUNTED HEAT SINK

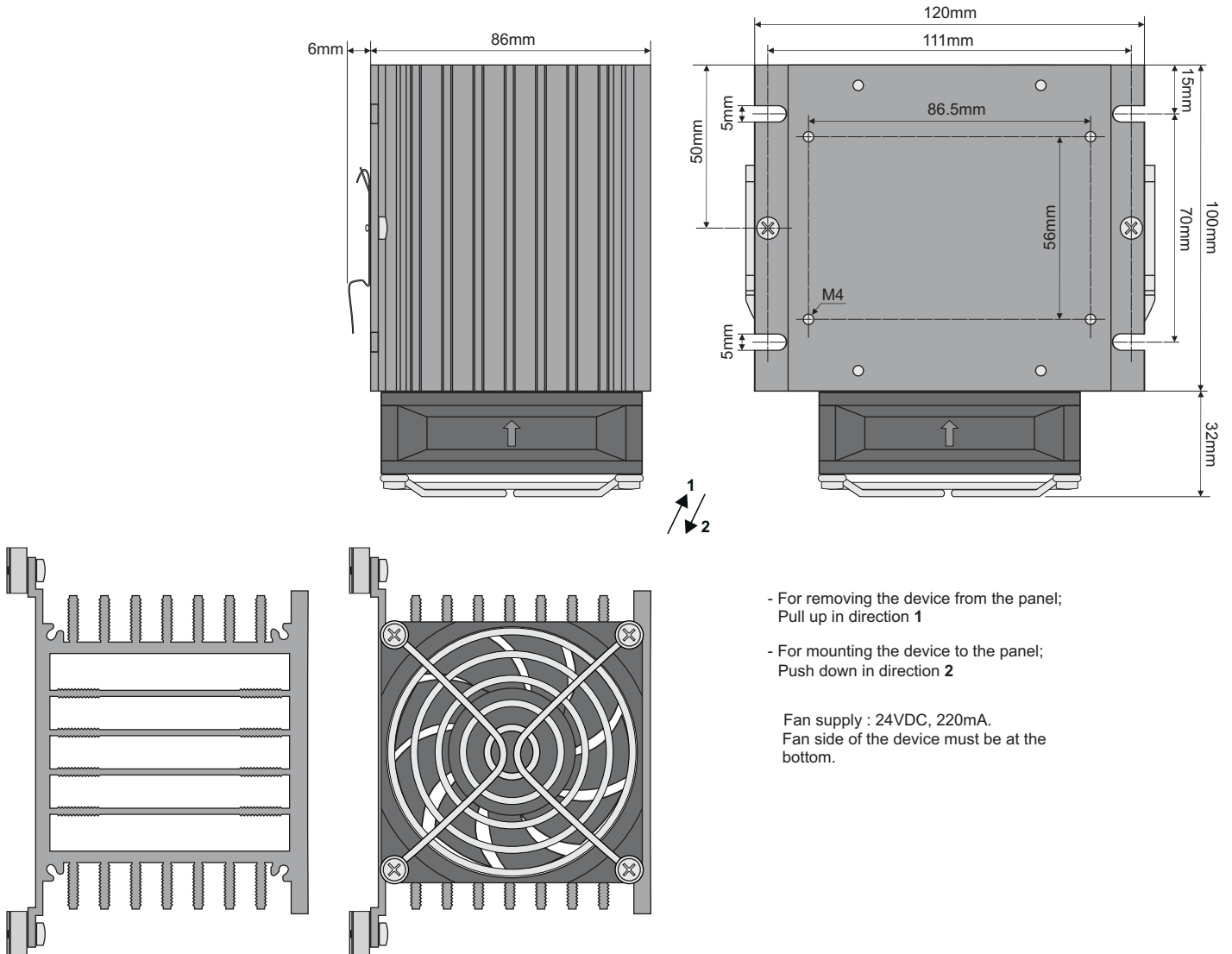

## Heat / Current Curves with ETS Series Heat Sinks for ENDA Panel Mounted SSR's

**EPxA1-212Z**

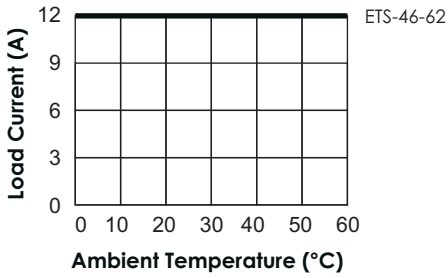

**EPxA1-225Z**

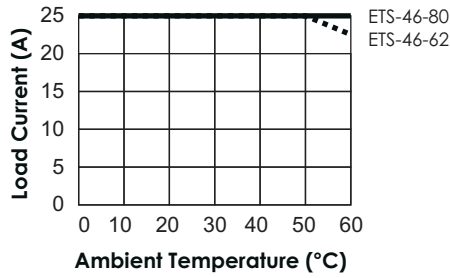

**EPxA1-240Z**

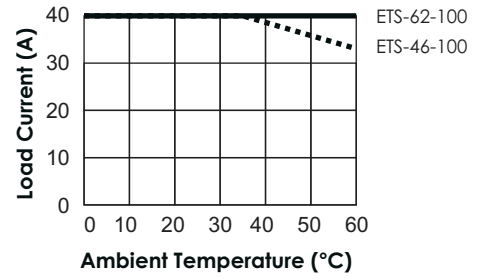

**EPxA1-425Z**

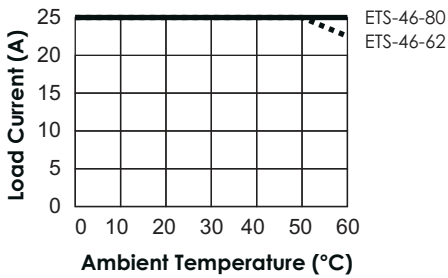

**EPxA1-440Z**

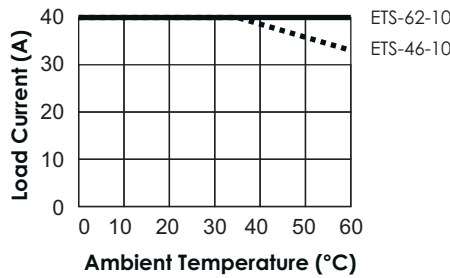

**EPxA1-450Z**

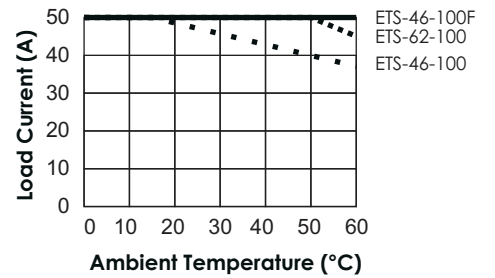

**EPxA1-470Z**

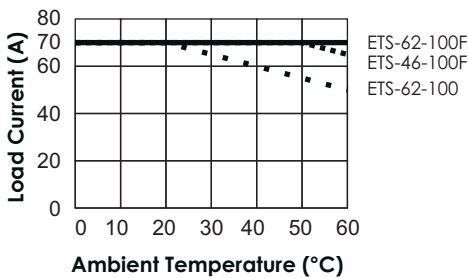

**EPxA1-4100Z**

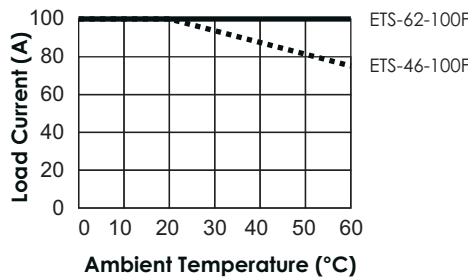

**EPxA1-4120Z**

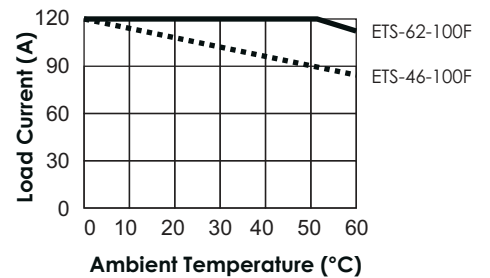

**EPxA3-425Z**

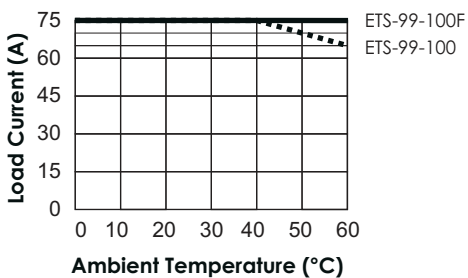

**EPxA3-440Z**

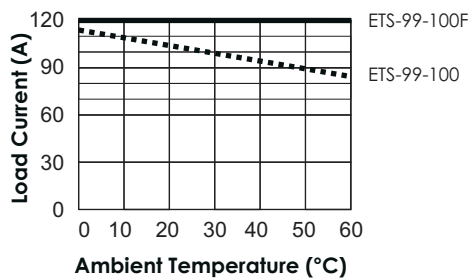

**EPxA3-450Z**

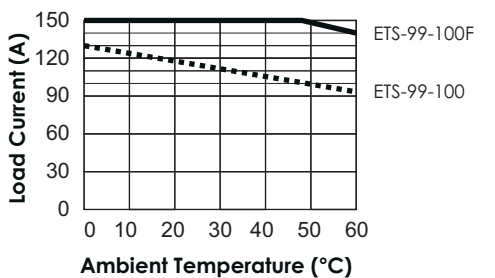

**SISEL MÜHENDİSLİK ELEKTRONİK SAN. VE TİC. A.Ş.**  
 Şerifali Mah. Barbaros Cad. No:18 Y.Dudullu 34775  
 ÜMRANIYE/İSTANBUL-TURKEY  
 Tel : +90 216 499 46 64 Pbx. Fax : +90 216 365 74 01  
 url : www.enda.com.tr

