



Read the user manual carefully before using the device! Responsibility for damages, losses and personal accidents caused by not following the warnings in the user manual belongs to the user. In this case, the device is out of warranty in case of malfunctions.

ENDA ECOOL1036 DIGITAL THERMOSTAT

Thank you for choosing ENDA ECOOL1036 Temperature Controller.

- ▶ 180x230x66 mm. sized,
- ▶ Control of fan cooling rooms,
- ▶ On-Off control,
- ▶ Features six relay outputs for cooling, defrost, fan, lighting, alarm and auxiliary (aux) control,
- ▶ Three NTC probe inputs for cooling, defrost, optional display,
- ▶ Two digital inputs in total, adjustable by door control and parameter,
- ▶ Offset settings that can be made for NTC probe inputs,
- ▶ Compressor protection feature with parameter,
- ▶ Compressor start, stop or periodic operation feature in probe failures,
- ▶ Selectable smart defrost feature,
- ▶ Manual fast cooling feature,
- ▶ Time and evaporator temperature dependent or manual defrosting feature,
- ▶ Ability to adjust set value lower and upper limits,
- ▶ Ability to adjust defrost time and interval,
- ▶ Ability to set lower and upper alarm limits dependent on the set value,
- ▶ Ability to display temperature units as °F and °C,
- ▶ Communication feature with RS485 ModBus RTU protocol,
- ▶ Parameter editing and uploading feature via NFC (optional),
- ▶ CE marked according to EN standards.



Order Code : ECOOL1036 -

1: NFC: NFC (Optional)



CONNECTION DIAGRAM



ENDA ECOOL1036 devices are wall mountable devices. The device must be used in accordance with the instructions. Installation and electrical connections must be made by technical personnel in accordance with the instructions in the user manual. There should be no electricity in the connecting cables during assembly. The device must be protected from moisture, vibration and pollution. Attention should be paid to the operating temperature. Assembly cables should not be routed near high power lines and devices.

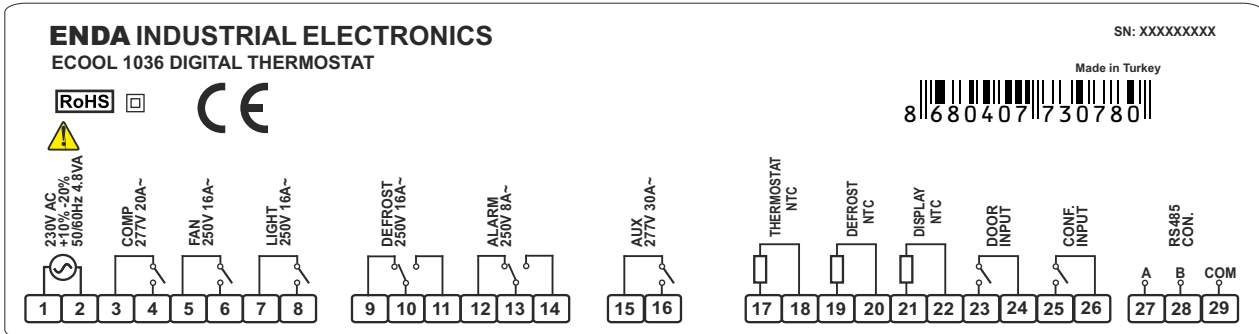

SUPPLY:

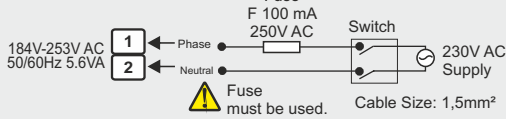

Not:

- 1) Mains supply cords shall meet the requirements of IEC 60227 or IEC 60245.
- 2) In accordance with the safety regulations, the power supply switch shall bring the identification of the relevant instrument and it should be easily accessible by the operator.



Equipment is protected throughout by **DOUBLE INSULATION**



Holding screw 0.4-0.5Nm.

DIMENSIONS - MONTAGE

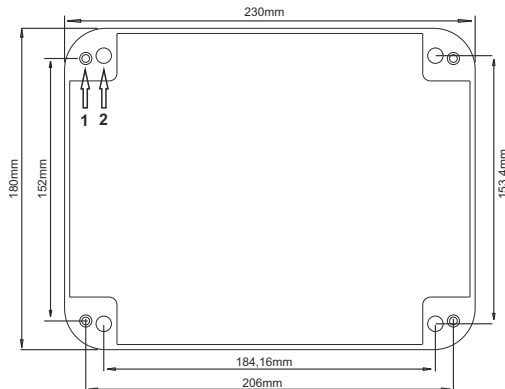

To mounting device;

- 1) Screws at point 1 should be removed and the front cover should be removed.
- 2) It should be mounted on the wall at the points indicated by number 2.
- 3) Electrical connection should be made by paying attention to the wiring diagram.
- 4) The cover should be closed and the removed screws should be tightened.

Note: If cable outlets are desired to be from the top rear cover with cable outlets facing up can be mounted on the wall.

TECHNICAL SPECIFICATIONS**ENVIRONMENTAL CONDITIONS**

Ambient/Storage Temperature	0 ... +50°C/-25 ... 70°C (without icing)
Relative Humidity	Relative humidity 80% for temperatures up to 31°C decreasing linearly to 50% relative humidity at 40°C.
Protection Class	IP65 according to EN 60529 standard.
Height	Max. 2000m.

⚠ Do not use the device in locations subject to corrosive and flammable gasses.

ELECTRICAL CHARACTERISTICS

Supply Voltage	230V AC +%-10 -%-20, 50/60Hz
Power Consumption	Max. 5.6VA
Connection	2.5 and 1.75 mm screw terminal connection
Scale	-60.0 ... +150.0°C (-76.0 ... +302.0°F)
Sensitivity	0.1°C (Can be selected as 0.1°C or 1°C.)
Accuracy	±1°C
Time Accuracy	±%1
Display	120x70mm, 3 digits and single point at the top, 4 digits and double dots at the bottom (minus digit at the top), 9 notification LEDs.
EMC	EN 61326-1: 2013
Safety Requirements	EN 61010-1: 2010 (Pollution degree 2, overvoltage category II)

OUTPUTS

Compressor Relay Output	For resistive load: NO 277V AC 20A , for inductive load: 2hp 250V AC Life for relay: Without load 10.000.000 switching, 277V AC 20A for resistive load 100.000 switching
Defrost Relay Output	For resistive load: NO 250V AC 16A ,NC 250V AC 16A, for inductive load : 1/2hp 240V AC Life expectancy for relay: Without load 30.000.000 switching, 250V AC, 16A for resistive load 100.000 switching
Fan Relay Output	For resistive load: NO 250V AC 16A , for inductive load : 1/2hp 240V AC Life expectancy for relay: Without load 30.000.000 switching, 250V AC, 16A for resistive load 100.000 switching
Lighting Relay Output	For resistive load: NO 250V AC 16A , for inductive load : 1/2hp 240V AC Life expectancy for relay: Without load 30.000.000 switching, 250V AC, 16A for resistive load 100.000 switching
Alarm Relay Output	For resistive load: NO 250V AC 8A , NC 250V AC 8A for inductive load: 1/2hp 240V AC Life expectancy for relay: Without load 30.000.000 switching, 250V AC, 8A for resistive load 100.000 switching
Auxiliary (AUX) Relay Output	For resistive load: NO 277V AC 20A , for inductive load: 2hp 250V AC Life for relay: Without load 10.000.000 switching, 277V AC 20A for resistive load 100.000 switching

CONTROL







Control Type	Compressor, defrost, fan, lighting, alarm and auxiliary output control with set values and digital inputs.
Control Algorithm	On-off control.
Hysteresis	Adjustable between 1 ... 20.0°C.

HOUSING









Housing Type	Wall mounted.
Size	180x230x66 mm
Weight	Approximately 1150g (as packaged)
Enclosure Material	Self-extinguishing plastics are used.

⚠ While cleaning the device, solvents (tinner, gasoline, acid etc.) or corrosive materials must not be used.

Indicator Leds Descriptions

Led	Descriptions
	When lit, the control is in the off state.
	Compressor is running while it is on, flashing, the start delay is active.
	While lit, defrost is running, flashing, the start delay is active.
	While lit, fan is running, flashing, the start delay is active.
	When lit, the lighting is on.
	- When lit in "Operation Mode", the alarm is active. - Indicates that the parameter has been transferred to the user menu when it is lit in "Programming Mode".
AUX	When lit, auxiliary output is active.
°C/°F	Temperature unit indicator leds. The active one shows the relevant unit.

Keyboard Descriptions

Key	Descriptions
	- In "Operation Mode" SET value, minimum-maximum measurement reset values, - Changing the value of the selected parameter in "Programming Mode" functions.
	- Displaying the maximum temperature measured in "Operation Mode", turning off the audible warning, - In "Programming Mode" it functions to increase the value of the selected parameter.
	- In "Operation Mode", displaying the minimum measured temperature value, - In "Programming Mode", it functions to decrease the value of the selected parameter.
	Turns the device on/off.
	It starts and stops the manual fast cooling.
	It starts and stops the manual defrost.
	It functions to activate and deactivate the lighting.
	Acts as auxiliary output activation and deactivation.

FRONT PANEL COMMANDS

Ç.5E. (Cooling Set) Displaying and Changing Value



In operating mode, the temperature value is displayed on the upper display and the SET value is displayed on the lower display. When the **SET** button is pressed, the set value on the lower display flashes and the set value is changed with the **▲**/**▼** buttons. Then, when the **SET** button is pressed again, the desired value is saved and the device returns to operating mode.

Viewing Minimum Temperature Measurement Value



If the **▼** key is pressed while in operation mode, 3 seconds. The minimum temperature value measured throughout is displayed.

Viewing Maximum Temperature Measurement Value



If the **▲** key is pressed while in operation mode, 3 seconds. The maximum temperature value measured throughout is displayed.

Resetting Maximum-Minimum Measurement Values



In operating mode, press **SET** button for 7 seconds. If it is kept pressed for a while, the maximum and minimum temperature measurement values are equal to the current measurement value. **rE5** message appears on the display.

Locking and Unlocking the Keys

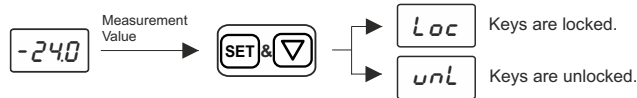

In operating mode, first hold down the **SET** button and then press the **▼** button for 2 seconds. If pressed together throughout, the **Loc** message is displayed and the keys are locked. When the same operation is performed with the keys locked, the message **unL** is displayed on the screen.

If any key is pressed while the keys are locked, the message **Loc** is displayed.

Manual Turning ON / OFF The Device

In working mode, press **⏻** button for 2 seconds. If it is pressed throughout, the **⏻** led is displayed and the control outputs become inactive. When the control outputs are disabled, press the **⏻** button for 2 seconds. If it is pressed throughout, the red **⏻** turns off and the device continues to perform its control function. Illumination when the control is off and the AUX outputs maintain their status and the relay position can be changed when the device is off.

Manual Fast Cooling Operation

In operating mode, if the device is not defrosting and control outputs are not closed, press the **⏻** key for 2 seconds. If it is pressed during the fast cooling process, it starts or stops. Compressor runs for **Ç.Ft** time. If the **Ç.Ft** parameter is 0, manual rapid cooling is not performed.

Manual Defrost Operation

If the control outputs are not closed in the operating mode, press the **⏻** key for 2 seconds. If pressed during the manual defrost operation is started or stopped.

Defrosting takes place as long as **dti** time. If **dti** parameter is 0, defrosting is not performed.

Activating / Deactivating Lighting Output

In operating mode, press the **⏻** key for 2 seconds. If pressed during, the lighting output is activated or deactivated.

Auxiliary Output (AUX) Arming / Ejecting

In operating mode, press **AUX** button for 2 seconds. If pressed during the auxiliary output is enabled or disabled.

Turning Off Beep and Alarm Output

When an alarm occurs, the alarm relay is activated along with the audible warning. By pressing the **⏻** key, the audible warning is turned off. Depending on the status of the **Rof** parameter, the alarm relay can remain active until the alarm disappears or the alarm output can be disabled.

If the key sound is to be turned off completely, when the device is in operating mode, if the **⏻** key is pressed and then the **⏻** key is pressed for 4 seconds, the "b-d i" message will be displayed on the lower screen and the key sounds will be turned off. When the same key combination is applied to turn on the key sounds, "b-E n" is written on the screen and the key sounds are activated.

Digital Inputs

1. Door Digital Input:

When the door is opened, the alarm output is activated at the end of the digital input delay time. Other outputs are enabled or disabled according to the **d lt** parameter. **d lo** message is displayed on the display.

2. Adjustable Digital Input:

The input becomes active and the digital input becomes active at the end of the digital input delay time. Related outputs are enabled or disabled according to the **d2t** parameter. The corresponding message is displayed according to the status set on the display.

Auxiliary (AUX) Output

Auxiliary output **oLP**. It can be used in four different ways according to the parameter:

- 1- If set to **non**: Auxiliary output is disabled.
- 2- If it is set to **Rout**: It can be activated or deactivated only with the AUX button on the front panel without any control.
- 3- If set to **onof**: Enabled when the device is turned on, disabled when the device is turned off.
- 4- If set as **cn2c**: The device performs the 2nd temperature control and the auxiliary output is activated or deactivated. In order for this control to work properly, attention should be paid to 5 parameters: **P3E**, **oP5**, **oCt**, **o5E**, **oHY**.

Restoring Factory Settings

If the **▼** key is pressed for 6 seconds after entering the **-P2** menu and setting the security parameter **-44**, the **dEFP** message is displayed on the lower display and the device restarts with the factory values.

Displaying the Revision Number

In operating mode, if **▲**/**▼** and then **AUX** keys are pressed together, **c36** **r n22** **0825** software code and revision date are displayed on the display, respectively.

Error - Warning - Alarm Definitions

Description	Outputs	Description	Outputs
Thermostat Probe malfunction. Check the sensor connection.	The alarm output is active. Compressor output works according to $\mathcal{L}Pn$ and $\mathcal{L}PF$ parameters. Other outputs are not affected.	Indicates that the password is incorrect. Check the password.	Outputs are not affected.
Defrost Probe malfunction. Check the sensor connection.	The alarm output is active. Other outputs are not affected.	Indicates that an external alarm has occurred. Check the operation of the system.	The alarm output is active. Other outputs are not affected.
Indicator Probe malfunction. Check the sensor connection.	The alarm output is active. Other outputs are not affected.	Indicates a serious external alarm. Please check the operation of the system.	The alarm output is active. Other outputs are closed.
Temperature upper limit exceeded alarm. Check the operation of the system.	The alarm output is active. Other outputs are not affected.	Indicates a door open alarm. Please check the operation of the system.	Alarm output is active. Other outputs vary according to dIt parameter.
Temperature lower limit exceeded alarm. Check the operation of the system.	The alarm output is active. Other outputs are not affected.	On devices with NFC option, this indicates that a factory reset has been performed. The message can be cleared by pressing any key.	Outputs are not affected.

PROGRAMMING THE DEVICE

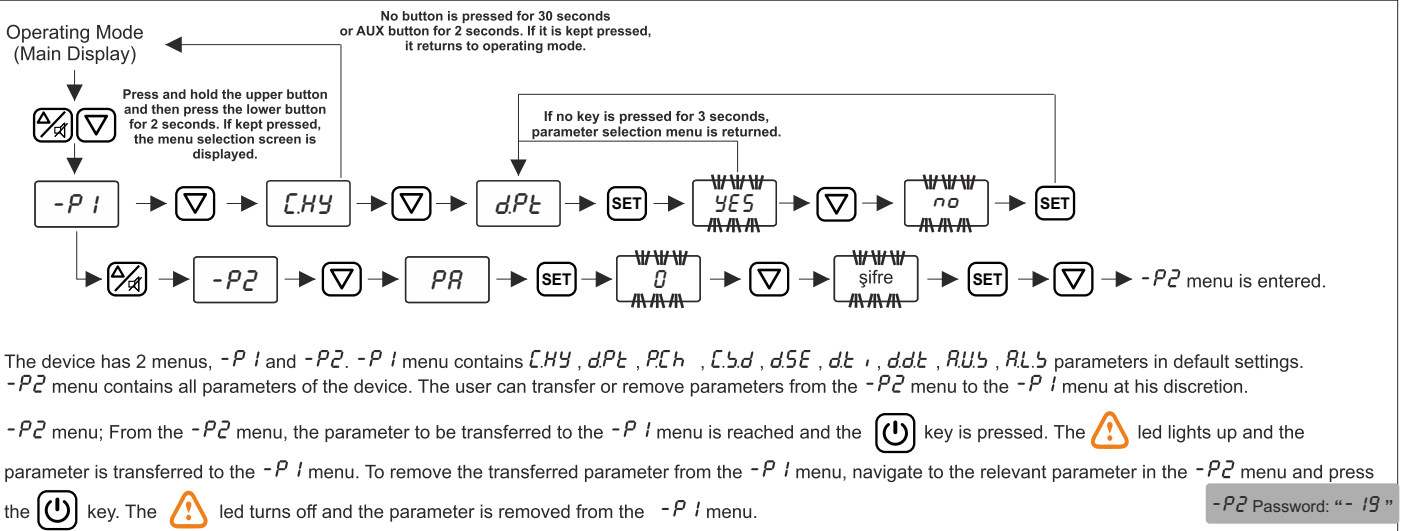

PARAMETER LIST

CONTROL PARAMETERS		Min.	Max.	Unit	Default
$\mathcal{C}UL$	Cooling setpoint upper limit	$\mathcal{C}LL$	150	°C / °F	150
$\mathcal{C}LL$	Cooling setpoint lower limit	-60	$\mathcal{C}UL$	°C / °F	-60
$\mathcal{C}HY$	Cooling hysteresis	1	20		2
$\mathcal{o}F5$	Cooling offset value	-20	20		0
CONFIGURATION PARAMETERS		Min.	Max.	Unit	Default
$b5E$	Should the buzzer be activated in alarm situations? (no : Don't activate, YES : Activate) (Not valid for probe malfunctions)	no	YES		YES
$Un i$	Temperature unit	°C	°F		°C
dPt	Decimal digit display	no	YES		YES
PCh	The sensor to be displayed on the display ($P1$: Thermostat probe, $P2$: Defrost probe, $P3$: Auxiliary probe, $P12$: ($P1-P2$) Temperature difference.)	$P1$	$P12$		$P1$
$P3E$	Should the auxiliary probe be used? (no : Auxiliary probe inactive, YES : Auxiliary probe active.)	no	YES		no
DIGITAL INPUT PARAMETERS		Min.	Max.	Unit	Default
dIP	Door digital input polarization ($\mathcal{C}L$: It is active when the digital input contact is closed, $\mathcal{o}P$: It is active when it is on.)	$\mathcal{C}L$	$\mathcal{o}P$		$\mathcal{C}L$
dIt	In case the door digital input is active, output states (non : Compressor, defrost, no change in fan outputs, $\mathcal{L}P$: Compressor off, FRn : Fan off, $\mathcal{L}-F$: Compressor and fan off, FR : Fan off lighting output on, $\mathcal{C}FR$: Compressor and fan off lighting output on.)	non	$\mathcal{C}FR$		FR
$d2P$	Adjustable digital input polarization ($\mathcal{C}L$: Active when digital input contact is closed, $\mathcal{o}P$: It is active when it is on.)	$\mathcal{C}L$	$\mathcal{o}P$		$\mathcal{C}L$
$d2t$	Digital input types (non : Digital input not used, ER : External alarm. $5R$: Important external alarm. df : Defrost operation is started. $Rout$: AUX output operation.)	nd	$Rout$		non
$d id$	Delay of digital inputs. Time it takes for digital inputs to be active.	00:00	99:59	min:sec	0:00
$d it$	Delay of door digital input control. Time to activate the buzzer after the door digital input is active.	00:00	99:59	min:sec	1:00
$dc t$	$d it$ control activity parameter after door digital input control delay is completed. (YES : $d it$ control is disabled after $d it$ times up and lighting output is not affect by this no : $d it$ times up is not affect $d it$ control.)	no	YES		no
COMPRESSOR PARAMETERS		Min.	Max.	Unit	Default
$\mathcal{L}Pd$	Time to activate the compressor after energizing	0:00	99:59	min:sec	0:10
$\mathcal{L}5d$	The time it takes for the compressor to restart after the stop	0:00	99:59	min:sec	1:00
$\mathcal{L}Pn$	Compressor on time in case of probe failure	0:00	2:00	hr:min	0:10
$\mathcal{L}PF$	Compressor off time in case of probe failure	0:00	2:00	hr:min	0:05
$\mathcal{L}Ft$	Manual rapid cooling run time	0:00	99:59	hr:min	0:00

DEFROST PARAMETERS		Min.	Max.	Unit	Default
<i>d.c.b.</i>	Smart defrost option (<i>n.o.</i> : Defrost time (time between 2 defrosts) is decreased regardless of compressor status. <i>y.e.b.</i> : Defrost time is decreased as long as the compressor is running.)	<i>n.o.</i>	<i>y.e.b.</i>		<i>n.o.</i>
<i>d.t.p.</i>	Defrost type selection (<i>ε.l.ε</i> = Electric (compressor off) defrost, <i>ç.a.b.</i> = Hot gas (compressor on) defrost)	<i>ε.l.ε</i>	<i>ç.a.b.</i>		<i>ε.l.ε</i>
<i>d.b.ε.</i>	Defrost stop temperature (If the temperature selected in the "d.d.o" parameter is higher than this value, defrost will not work.)	<i>-60</i>	<i>150</i>	°C / °F	<i>2</i>
<i>d.d.o.</i>	Conditions where the defrost stop temperature is dependent (it works according to the "d.b.ε." parameter) <i>n.p.</i> = No sensor, timed defrost works. <i>p.1</i> = Defrost works according to thermostat temperature (<i>P.1</i>). <i>p.2</i> = Defrost works according to the defrost temperature (<i>P.2</i>). <i>p.3</i> = Defrost works according to auxiliary probe temperature (<i>P.3</i>).	<i>n.p.</i>	<i>p.3</i>		<i>p.2</i>
<i>d.t.i.</i>	Defrost time (When <i>d.t.i.</i> = 0, automatic and manual defrost is disabled.)	<i>0:00</i>	<i>99:59</i>	min:sec	<i>20:00</i>
<i>d.d.t.</i>	Time between two successive defrosts	<i>0:00</i>	<i>99:59</i>	hr:min	<i>6:00</i>
<i>d.d.f.</i>	Defrost delay time after fast cooling	<i>0:00</i>	<i>99:59</i>	hr:min	<i>2:00</i>
<i>d.d.ε.</i>	Display configuration during defrost <i>r.ε</i> : Actual temperature continues to be displayed during defrost. <i>l.ε</i> : During defrost, the last measured temperature before entering defrost is seen on the display. <i>d.ε.f.</i> : During defrost, the message <i>d.ε.f.</i> is displayed on the screen.	<i>r.ε</i>	<i>d.ε.f.</i>		<i>r.ε</i>
<i>d.d.ε.</i>	Delay for displaying actual temperature after defrost ends	<i>0:00</i>	<i>99:59</i>	min:sec	<i>1:00</i>
<i>d.p.r.</i>	Defrost operation starts with energy (<i>n.o.</i> : Defrost does not start when energy comes on, <i>y.e.b.</i> : Defrost starts when energy comes on.)	<i>n.o.</i>	<i>y.e.b.</i>		<i>n.o.</i>
<i>d.p.d.</i>	Defrost start delay after energizing	<i>0:00</i>	<i>99:59</i>	min:sec	<i>1:00</i>
<i>d.t.d.</i>	Drip (discharge) time	<i>0:00</i>	<i>99:59</i>	min:sec	<i>2:00</i>
FAN PARAMETERS		Min.	Max.	Unit	Default
<i>f.c.n.</i>	Fan control functions <i>o.n.</i> = Fan operates depending on the states of <i>f.c.b.</i> , <i>f.d.b.</i> , <i>f.p.d.</i> , <i>f.d.d.</i> , it runs continuously when not controlled by these 4 parameters. <i>p.1</i> = If the evaporator temperature (<i>P.2</i>) is above <i>f.b.ε</i> , the fan will not operate. <i>f.b.ε</i> - <i>f.h.y</i> If it is below the value, it works. <i>p.1-2</i> = difference between room temperature and evaporator temperature (<i>P.12</i>); <i>f.b.ε</i> + <i>f.h.y</i> If it is above the <i>f.b.ε</i> value, the fan works, if it is below the <i>f.b.ε</i> value, it does not work.	<i>o.n.</i>	<i>p.1-2</i>		<i>o.n.</i>
<i>f.b.ε.</i>	Fan stop temperature	<i>-60</i>	<i>150</i>	°C / °F	<i>1</i>
<i>f.h.y.</i>	Fan hysteresis	<i>1</i>	<i>20</i>		<i>2</i>
<i>f.c.b.</i>	Fan stops when compressor stops (<i>n.o.</i> = Fan keeps status, <i>y.e.b.</i> = Fan stops together with compressor.)	<i>n.o.</i>	<i>y.e.b.</i>		<i>y.e.b.</i>
<i>f.d.b.</i>	Fan stop during defrost (<i>n.o.</i> = Fan keeps status, <i>y.e.b.</i> = Fan stops during defrost.)	<i>n.o.</i>	<i>y.e.b.</i>		<i>y.e.b.</i>
<i>f.p.d.</i>	Time to activate the fan after energizing	<i>00:00</i>	<i>99:59</i>	min:sec	<i>0:00</i>
<i>f.d.d.</i>	Time to start the fan after defrost	<i>00:00</i>	<i>99:59</i>	min:sec	<i>3:00</i>
ALARM PARAMETERS		Min.	Max.	Unit	Default
<i>r.u.b.</i>	The alarm high setpoint may need to be reprogrammed after <i>R.t.p.</i> changes.	<i>R.l.b.</i>	<i>150</i>		<i>150</i>
<i>R.l.b.</i>	The alarm lower level setpoint may need to be reprogrammed after <i>R.t.p.</i> changes.	<i>-60</i>	<i>R.u.b.</i>	°C / °F	<i>-60</i>
<i>R.h.y.</i>	Alarm hysteresis	<i>1</i>	<i>20</i>		<i>2</i>
<i>R.d.d.</i>	Alarm message display delay after alarm condition occurs	<i>00:00</i>	<i>99:59</i>	min:sec	<i>0:00</i>
<i>R.d.p.</i>	Alarm message display delay after energized	<i>00:00</i>	<i>99:59</i>	hr:min	<i>0:10</i>
<i>R.t.p.</i>	Alarm configuration (<i>R.b.b.</i> : Absolute alarm, <i>r.ε.f.</i> : Relative alarm.) If <i>R.t.p.</i> = <i>R.b.b.</i> , Alarm values are <i>R.l.b.</i> and <i>R.u.b.</i> If <i>R.t.p.</i> = <i>r.ε.f.</i> , Alarm values are <i>R.l.b.</i> = <i>ε.b.ε</i> - <i>R.l.b.</i> , <i>R.u.b.</i> = <i>ε.b.ε</i> + <i>R.u.b.</i>	<i>R.b.b.</i>	<i>r.ε.f.</i>		<i>R.b.b.</i>
<i>R.o.f.</i>	Disable alarm output before alarm condition is lifted? (<i>n.o.</i> = Audible alarm is silenced only, <i>y.e.b.</i> = Audible alarm and alarm relay are disabled.)	<i>n.o.</i>	<i>y.e.b.</i>		<i>n.o.</i>
AUXILIARY OUTPUT (AUX) PARAMETERS		Min.	Max.	Unit	Default
<i>a.t.p.</i>	Auxiliary output type (<i>n.o.n.</i> : cannot be used, <i>R.o.u.t.</i> : works as auxiliary output, <i>o.n.o.f.f.</i> : works as On-off function, <i>d.i.2.</i> : Active with digital input, <i>c.n.t.2.</i> : works as 2nd control.)	<i>n.o.n.</i>	<i>c.n.t.2.</i>		<i>R.o.u.t.</i>
<i>a.p.b.</i>	When the auxiliary output is used as <i>c.n.t.2.</i> , probe selection (<i>P.1</i> : Thermostat probe, <i>P.2</i> : Defrost probe, <i>P.3</i> : Control is made by selecting auxiliary probe (Check the <i>P.3.ε</i> parameter).	<i>P.1</i>	<i>P.3</i>		<i>P.3</i>
<i>a.c.t.</i>	When used as auxiliary output <i>c.n.t.2.</i> , cooling-heating selection (<i>H.ε.R.t.</i> : Heating control, <i>ε.o.o.l.</i> : Cooling control is done)	<i>H.ε.R.t.</i>	<i>ε.o.o.l.</i>		<i>ε.o.o.l.</i>
<i>a.b.ε.</i>	Setpoint when used as auxiliary output <i>c.n.t.2.</i>	<i>-60</i>	<i>150</i>	°C / °F	<i>0</i>
<i>a.h.y.</i>	Cooling / heating hysteresis value when used as auxiliary output <i>c.n.t.2.</i>	<i>1</i>	<i>20</i>		<i>2</i>
MODBUS COMMUNICATION PARAMETERS		Min.	Max.	Unit	Default
<i>R.d.r.</i>	Slave device address selection	<i>1</i>	<i>247</i>		<i>1</i>
<i>b.d.r.</i>	Communication speed selection	<i>o.f.f.</i>	<i>560</i>	bps	<i>96</i>

ENDA ECOOL1036 DIGITAL COOLING CONTROLLER MODBUS PROTOCOL ADDRESS MAP

1.1 HOLDING REGISTERS

Holding Register Addresses		Data Type	Content of Data	Parameter Name	Read / Write Permission
Decimal	Hex				
0000d	0x0000	word	Cooling set value (Can be adjusted between <i>C.L.L.</i> value and C.U.L value.)	<i>C.S.E.</i>	Readable/Writable
0001d	0x0001	word	Upper limit for cooling set point (Can be adjusted between <i>C.L.L.</i> value and 150 value.)	<i>C.U.L.</i>	Readable/Writable
0002d	0x0002	word	Lower limit for cooling set point (It can be adjusted between -60 value and <i>C.U.L.</i> value.)	<i>C.L.L.</i>	Readable/Writable
0003d	0x0003	word	Cooling hysteresis (It can be adjusted between 1 value and 20 value.)	<i>C.H.Y.</i>	Readable/Writable
0004d	0x0004	word	Cooling offset value (It can be adjusted between -20 value and 20 value.)	<i>C.O.F.S.</i>	Readable/Writable
0005d	0x0005	word	Sensor to be displayed on the display (0= <i>P 1</i> , 1= <i>P2</i> , 2= <i>P3</i> , 3= <i>P 12</i>)	<i>P.C.h.</i>	Readable/Writable
0006d	0x0006	word	Door digital input types (0= <i>n o n</i> , 1= <i>C P</i> , 2= <i>F R n</i> , 3= <i>C - F</i> , 4= <i>F R</i> , 5= <i>C F R</i>)	<i>d i.t.</i>	Readable/Writable
0007d	0x0007	word	Adjustable digital input types (0= <i>n o n</i> , 1= <i>E R</i> , 2= <i>S R</i> , 3= <i>d F</i> , 4= <i>R o u t</i>)	<i>d2.t.</i>	Readable/Writable
0008d	0x0008	word	Digital input delay (It can be adjusted between 00:00 minutes 99:59 minutes:seconds.)	<i>d .i.d.</i>	Readable/Writable
0009d	0x0009	word	Delay of door digital input control. (It can be adjusted between 00:00 minutes 99:59 minutes:seconds.)	<i>d .i.t.</i>	Readable/Writable
0010d	0x000A	word	Time to activate the compressor after energizing (It can be adjusted between 00:00 minutes 99:59 minutes:seconds.)	<i>C.P.d.</i>	Readable/Writable
0011d	0x000B	word	The time it takes for the compressor to restart after the stop (It can be adjusted between 00:00 minutes 99:59 minutes:seconds.)	<i>C.S.d.</i>	Readable/Writable
0012d	0x000C	word	Ten times of compressor output on probe failure (It can be adjusted between 00:00 hours 02:00 hours:minutes.)	<i>C.P.n</i>	Readable/Writable
0013d	0x000D	word	Compressor output off time in probe failure (It can be adjusted between 00:00 hours 02:00 hours:minutes.)	<i>C.P.F</i>	Readable/Writable
0014d	0x000E	word	Fast cooling time (can be adjusted between 00:00 hours 99:59 hours:minutes)	<i>C.F.t.</i>	Readable/Writable
0015d	0x000F	word	Conditions where the defrost stop temperature is dependent (0= <i>n P</i> , 1= <i>P 1</i> , 2= <i>P2</i> ,3= <i>P3</i>)	<i>d.d.o</i>	Readable/Writable
0016d	0x0010	word	Defrost stop temperature set value (Can be adjusted between -60 value and 150 value.)	<i>d.S.E.</i>	Readable/Writable
0017d	0x0011	word	Defrost time (It can be adjusted between 00:00 minutes 99:59 minutes:seconds.)	<i>d.t .i.</i>	Readable/Writable
0018d	0x0012	word	The time between two successive defrosts (It can be adjusted between 00:00 hours 99:59 hours:minutes.)	<i>d.d.t.</i>	Readable/Writable
0019d	0x0013	word	Defrost delay time after fast cooling (It can be adjusted between 00:00 hours 99:59 hours:minutes.)	<i>d.d.F</i>	Readable/Writable
0020d	0x0014	word	Delay for displaying actual temperature after defrosting ends (It can be adjusted between 00:00 minutes 99:59 minutes:seconds.)	<i>d.d.E</i>	Readable/Writable
0021d	0x0015	word	Defrost start delay after energizing (It can be adjusted between 00:00 minutes 99:59 minutes:seconds.)	<i>d.P.d.</i>	Readable/Writable
0022d	0x0016	word	Drip (discharge) time (Can be adjusted between 00:00 minutes 99:59 minutes:seconds.)	<i>d.t.d.</i>	Readable/Writable
0023d	0x0017	word	Fan control functions (0= <i>n P</i> , 1= <i>P 1</i> , 2= <i>P 1-2</i>)	<i>F.C.n</i>	Readable/Writable
0024d	0x0018	word	Fan stop temperature (It can be adjusted between -60 value and 150 value.)	<i>F.S.E.</i>	Readable/Writable
0025d	0x0019	word	Fan hysteresis (It can be adjusted between 1 value and 20 value.)	<i>F.H.Y.</i>	Readable/Writable
0026d	0x001A	word	The time it takes for the fan to activate after energizing (It can be adjusted between 00:00 minutes 99:59 minutes:seconds.)	<i>F.P.d.</i>	Readable/Writable
0027d	0x001B	word	The time it takes for the fan to activate after defrosting (It can be adjusted between 00:00 minutes 99:59 minutes:seconds.)	<i>F.d.d.</i>	Readable/Writable
0028d	0x001C	word	Alarm upper level set value (Can be adjusted between <i>R.L.S.</i> value and 150 value.)	<i>R.U.S.</i>	Readable/Writable
0029d	0x001D	word	Alarm lower level set value (Can be adjusted between -60 value and <i>R.U.S.</i> value.)	<i>R.L.S.</i>	Readable/Writable
0030d	0x001E	word	Alarm hysteresis (It can be adjusted between 1 value and 20 value.)	<i>R.H.Y.</i>	Readable/Writable
0031d	0x001F	word	Delay to show alarm message after alarm condition occurs (It can be adjusted between 00:00 minutes 99:59 minutes:seconds.)	<i>R.d.d.</i>	Readable/Writable
0032d	0x0020	word	Delay to show alarm message after energizing (It can be adjusted between 00:00 hours 99:59 hours:minutes.)	<i>R.d.P.</i>	Readable/Writable
0033d	0x0021	word	Auxiliary output type selection (0= <i>n o n</i> , 1= <i>R o u t</i> , 2= <i>o n o F</i> , 3= <i>d i2</i> , 4= <i>c n t2</i>)	<i>a.t.P</i>	Readable/Writable
0034d	0x0022	word	Auxiliary output probe type selection (0= <i>P 1</i> , 1= <i>P2</i> , 2= <i>P3</i>)	<i>a.P.S.</i>	Readable/Writable
0035d	0x0023	word	Auxiliary output setpoint(It can be adjusted between -60 value and 150 value.)	<i>a.S.E.</i>	Readable/Writable
0036d	0x0024	word	Auxiliary output hysteresis (It can be adjusted between 1 and 20 values.)	<i>a.H.Y.</i>	Readable/Writable
0037d	0x0025	word	Slave address selection (It can be adjusted between value 1 and value 247.)	<i>R.d.r.</i>	Readable/Writable
0038d	0x0026	word	Modbus communication speed selection (It can be adjusted between value 0 and value 6.) 0 = OFF 1= 2.4 bps, 2 = 4.8 bps, 3 = 9.6 bps, 4 = 19.2 bps,5 = 38.4 bps, 6 = 56 bps	<i>b.d.r.</i>	Readable/Writable
0039d	0x0027	word	Display configuration during defrost (0 = <i>r E</i> , 1 = <i>L c</i> 2 = <i>d E F</i>)	<i>d.d.C.</i>	Readable/Writable

* Among the Holding and Input Register parameters, those of integer type are defined as signed integers and these parameters are with the decimal part. (A parameter with a value of "14.0" will be read as "140").

Time-related parameters (those of the "min:sec" type and "hr:min" type) are defined as hexadecimal.

For example;

1- The hexadecimal value of a parameter set to 0 1: 19 in min:sec is 119. The decimal equivalent of 119 is 281. In Modbus, this time is read as "281".

2- The hexadecimal value of a parameter set as 02:54 in hr:min is 254. The decimal equivalent of 254 is 596. In Modbus, this time is read as "596".



1.2 INPUT REGISTERS

Input Register Addresses		Data Type	Content of Data	Parameter Name	Read / Write Permission
Decimal	Hex				
0000d	0x0000	word	Measured thermostat probe temperature value (°C / °F)	-	Read Only
0001d	0x0001	word	Measured defrost probe temperature value (°C / °F)	-	Read Only
0002d	0x0002	word	Measured auxiliary probe temperature (°C / °F)	-	Read Only
0003d	0x0003	word	The lowest measured temperature (shown on the display) value (°C / °F)	-	Read Only
0004d	0x0004	word	The highest measured temperature (shown on the display) value (°C / °F)	-	Read Only

*Input Register parameters are defined as signed integers and these parameters are with decimal point. (A parameter with a value of "14.0" will be read as "140").

1.3 DISCRETE INPUTS

Discrete Inputs Addresses		Data Type	Content of Data	Parameter Name	Read / Write Permission
Decimal	Hex				
0000d	0x0000	bit	Compressor relay output status (0=OFF; 1=ON)	--	Read Only
0001d	0x0001	bit	Defrost relay output status (0=OFF; 1=ON)	--	Read Only
0002d	0x0002	bit	Fan relay output status (0=OFF; 1=ON)	--	Read Only
0003d	0x0003	bit	Lighting relay output status (0=OFF; 1=ON)	--	Read Only
0004d	0x0004	bit	Alarm relay output status (0=OFF; 1=ON)	--	Read Only
0005d	0x0005	bit	AUX relay output status (0=OFF; 1=ON)	--	Read Only
0006d	0x0006	bit	Door digital input active status (0=OFF; 1=ON)	--	Read Only
0007d	0x0007	bit	Configurable digital input active status (0=OFF; 1=ON)	--	Read Only
0008d	0x0008	bit	Thermostat probe failure (0 = No error, 1 = Error present)	<i>P1F</i>	Read Only
0009d	0x0009	bit	Defrost probe failure (0 = No error, 1 = Error present)	<i>P2F</i>	Read Only
0010d	0x000A	bit	Display probe failure (0 = No error, 1 = Error present)	<i>P3F</i>	Read Only
0011d	0x000B	bit	High temperature alarm (0 = No alarm, 1 = Alarm present)	<i>HRL</i>	Read Only
0012d	0x000C	bit	Low temperature alarm (0 = No alarm, 1 = Alarm present)	<i>LRL</i>	Read Only
0013d	0x000D	bit	Digital input external alarm (0 = No alarm, 1 = Alarm present)	<i>ER</i>	Read Only
0014d	0x000E	bit	Digital input serious external alarm (0 = No alarm, 1 = Alarm present)	<i>SR</i>	Read Only
0015d	0x000F	bit	Door open alarm (0 = No alarm, 1 = Alarm present)	<i>dlo</i>	Read Only

1.4 COILS

Coil Addresses		Data Type	Content of Data	Parameter Name	Read / Write Permission
Decimal	Hex				
00d	0x00	Bit	Temperature unit ($0 = ^\circ C, 1 = ^\circ F$)	<i>Unit</i>	Readable/Writable
01d	0x01	Bit	Decimal point ($0 = no, 1 = yes$)	<i>dPt</i>	Readable/Writable
02d	0x02	Bit	Should the auxiliary probe be used? ($0 = no, 1 = yes$)	<i>P3E</i>	Readable/Writable
03d	0x03	Bit	Door digital input polarity ($0 = cL, 1 = oP$)	<i>d1P</i>	Readable/Writable
04d	0x04	Bit	Can be set digital input polarity ($0 = cL, 1 = oP$)	<i>d2P</i>	Readable/Writable
05d	0x05	Bit	<i>d.it</i> control activity parameter ($0 = no, 1 = yes$)	<i>dc.t</i>	Readable/Writable
06d	0x06	Bit	Smart defrost selection ($0 = no, 1 = yes$)	<i>dc.b</i>	Readable/Writable
07d	0x07	Bit	Defrost type selection ($0 = ELI, 1 = GR5$)	<i>d.tP</i>	Readable/Writable
08d	0x08	Bit	Defrosting process begins with energy ($0 = no, 1 = yes$)	<i>dPr.</i>	Readable/Writable
09d	0x09	Bit	The case when the fan stops with the compressor ($0 = no, 1 = yes$)	<i>FLS</i>	Readable/Writable
10d	0x0A	Bit	Fan stop during defrost ($0 = no, 1 = yes$)	<i>F.d.b</i>	Readable/Writable
11d	0x0B	Bit	Alarm configuration ($0 = AbS$ Standalone alarm , $1 = rEF$ Relative alarm)	<i>RLP</i>	Readable/Writable

1.4 COILS CONTINUED					
Coil Addresses		Data Type	Content of Data	Parameter Name	Read / Write Permission
Decimal	Hex				
12d	0x0C	Bit	Disable alarm output before alarm condition is lifted? (0 = No, 1 = Yes)	R.oF.	Readable/Writable
13d	0x0D	Bit	AUX output control type (heating-cooling) (0 = HEAT, 1 = COOL)	a.C.t.	Readable/Writable
14d	0x0E	Bit	Should the device be turned off? (0 = No, 1 = Yes)		Readable/Writable
15d	0x0F	Bit	Rapid cooling (0 = No, 1 = Yes)	--	Readable/Writable
16d	0x10	Bit	Starting a manual defrost (0 = No, 1 = Yes)	--	Readable/Writable
17d	0x11	Bit	Activating the lighting (0 = No, 1 = Yes)	--	Readable/Writable
18d	0x12	Bit	AUX output (0 = Off, 1 = On)	--	Readable/Writable
19d	0x13	Bit	Locking the keys (0 = No, 1 = Yes)	--	Readable/Writable
20d	0x14	Bit	Alarm output and sound status (0 = No, 1 = Yes)	--	Readable/Writable
21d	0x15	Bit	Should the buzzer be activated in alarm situations? (0 = No, 1 = Yes)	b.b.E	Readable/Writable

NFC





EndaLink is a mobile application that provides fast and secure data sharing between NFC supported ENDA devices and mobile devices.

 To communicate with an NFC supported ENDA device, your mobile device must have NFC support.

You can scan the QR code below to access our EndaLink application on Google Play and the App Store.



Resetting the NFC Password via EndaLink

When an NFC password reset command is sent via EndaLink, if the device's display shows the message "P.C.L" and an audible alert is given at the same time, it means that the NFC password has been successfully reset. If the "P.C.L" message is not displayed, the reset operation has failed.