



Read this document carefully before using this device. The guarantee will be expired by device damages if you don't attend to the directions in the user manual. Also we don't accept any compensations for personal injury, material damage or capital disadvantages.

# ENDA EPV542 PROGRAMMABLE AC/DC VOLTMETER

Thank you for choosing ENDA EPV542 Programmable AC/DC voltmeter.

- ▶ 54 x 94 mm sized
- ▶ 3 digits display
- ▶ Selectable number of decimal point
- ▶ Easy to use front panel keypad
- ▶ Multi-function alarm output for lower and upper limits (NO + NC)
- ▶ Multi-function alarm setpoints with alarm output (NO)
- ▶ Communication feature over isolated RS485, using ModBus RTU protocol (Optional)
- ▶ Keylock feature
- ▶ Measuring type can be selected as AC, DC or true RMS (ACDC)
- ▶ CE Marked according to European Norms.



**RoHS**  
Compliant



Order Code : EPV542-1-2-3

<b>1 - Supply Voltage</b> UV.....90-250V AC  LV.....10-30V DC / 8-24V AC	<b>2 - Output</b> R.....08A Relay	<b>3 - Modbus</b> RSI.....RS485 Modbus Available (Specify at order)
--	--------------------------------------	---

## TECHNICAL SPECIFICATIONS

ENVIRONMENTAL CONDITIONS	
Ambient / Storage Temperature	0 ... +50°C/-25 ... +70°C (with no icing)
Max. Relative Humidity	80% Relative humidity for temperatures up to 31°C, decreasing linearly to 50% at 40°C.
Rated Pollution Degree	According to EN 60529 ; Front Panel : IP65, Rear Panel : IP20
Height	Max. 2000m
Do not use the device in locations subject to corrosive and flammable gases.	
ELECTRICAL CHARACTERISTICS	
Supply Voltage	90-250V AC 50/60Hz ; 10-30V DC / 8-24V AC SMPS
Power Consumption	Max. 5VA
Wiring	2.5mm <sup>2</sup> screw-terminal connections
Scale	<b>AC and RMS</b> If <i>iL 500</i> is selected, between 0 and 500V. If <i>iL 100</i> is selected, between 0 and 100V. <b>DC</b> If <i>iL 500</i> is selected, between -500V DC and 500V DC. If <i>iL 100</i> is selected, between -100V DC and 100V DC.
Sensitivity	0,01V ( If, <i>iL 100</i> is selected ) 0,1V ( If, <i>iL 500</i> is selected and higher than -100V, lower from 100V for input values ) 1V ( If <i>iL 500</i> is selected and lower than -100V, higher from 100V for input values )
Accuracy	<b>AC</b> ±%1 ( Full scale ) ( For square wave form ± 2% ) <b>DC</b> ±%1 ( Full scale ) <b>RMS</b> ±%1 ( Full scale ) ( For square wave form ± 2% )
Input Range	-500V...500V ( If <i>iL 500</i> is selected, device breaks down at more than ±1250 DC voltages ) -100V...100V ( If <i>iL 100</i> is selected, device breaks down at more than ±125 DC voltages )
Input Impedance	870kΩ
Frequency Range	DC , 10Hz - 200Hz (For square wave form 10Hz-70Hz)
EMC	EN 61326-1: 2013
Safety Requirements	EN 61010-1: 2010 (Pollution degree 2, overvoltage category II)
OUTPUTS	
Output	Relay: 250V AC, 8A (for resistive load), NO+NC
Life Expectancy for Relay	Mechanical 30.000.000 operation; 100.000 operation at 250V AC, 10A resistive load.
HOUSING	
Housing Type	Suitable for flush-panel mounting. (According to DIN 43 700)
Dimensions	W54xH94xD68mm
Weight	Approx. 250g (after packing)
Enclosure Material	Self extinguishing plastics.
While cleaning the device, solvents (thinner, gasoline, acid etc.) or corrosive materials must not be used.	

# Dimensions

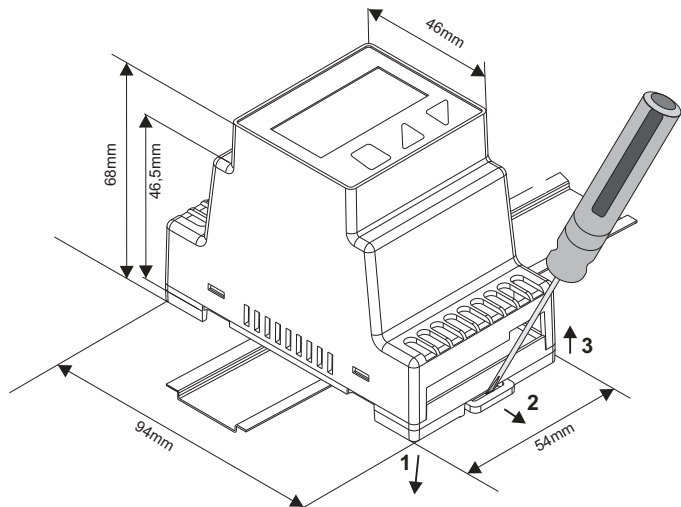

**For mounting the device to the panel;**  
Push the device in direction 1 , the rails provide the key to keeping the rail.

**For removing the device from rail;**  
Push the rail lock in direction 2 with a screwdriver and pull the device in direction 3 .

**NOTE :**  
**SUPPLY:**  
90-250V AC  
veya  
10-30V DC/  
8-24VAC  
50/60Hz 5VA

Note: 1) Mains supply cords shall meet the requirements of IEC 60227 or IEC 60245.  
2) In accordance with the safety regulations, the power supply switch shall bring the identification of the relevant instrument and it should be easily accessible by the operator.

⚠ Fuse should be connected. Cable Size: 1,5mm<sup>2</sup>;

☐ Equipment is protected throughout by **DOUBLE INSULATION**

🔩 Holding screw  
0.4-0.5Nm.

# Connection Diagram



**ENDA EPV542** series voltmeters are rail mounted devices. Make sure that the device is used only for intended purpose. The electrical connections must be carried out by a qualified staff and must be according to the relevant locally applicable regulations. During an installation, all of the cables that are connected to the device must be free of electrical power. The device must be protected against inadmissible humidity, vibrations, severe soiling. Make sure that the operation temperature is not exceeded. The cables should not be close to the power cables or components.



If *It 5P* input type "500" is selected, the measurement terminals 1 and 4 of the terminals must be connected. Otherwise, measurement will be incorrect.

If *It 5P* input type "100" is selected, the measurement terminals 2 and 3 of the terminals must be connected. Otherwise, measurement will be incorrect.

**ENDA INDUSTRIAL ELECTRONICS**  
**EPV542-UV**  
AC/DC VOLTMETER **RoHS**

90-250V AC  
50/60Hz 5VA

Max. 500V AC/DC  
Max. 100V AC/DC

CE CAT II Made in Turkey  
SN: XXXXXXXXX

**ENDA INDUSTRIAL ELECTRONICS**  
**EPV542-UV-RSI**  
AC/DC VOLTMETER **RoHS**

90-250V AC +10% -20%  
50/60Hz 5VA

Max. 500V AC/DC  
Max. 100V AC/DC

CE CAT II Made in Turkey  
SN: XXXXXXXXX

**ENDA INDUSTRIAL ELECTRONICS**  
**EPV542-LV-R**  
AC/DC VOLTMETER **RoHS**

10-30V DC/8-24V AC  
50/60Hz 4,5VA

Max. 500V AC/DC  
Max. 100V AC/DC

CE CAT II Made in Turkey  
SN: XXXXXXXXX

**ENDA INDUSTRIAL ELECTRONICS**  
**EPV542-LV-R-RSI**  
AC/DC VOLTMETER **RoHS**

10-30V DC/8-24V AC  
50/60Hz 4,5VA

Max. 500V AC/DC  
Max. 100V AC/DC

CE CAT II Made in Turkey  
SN: XXXXXXXXX

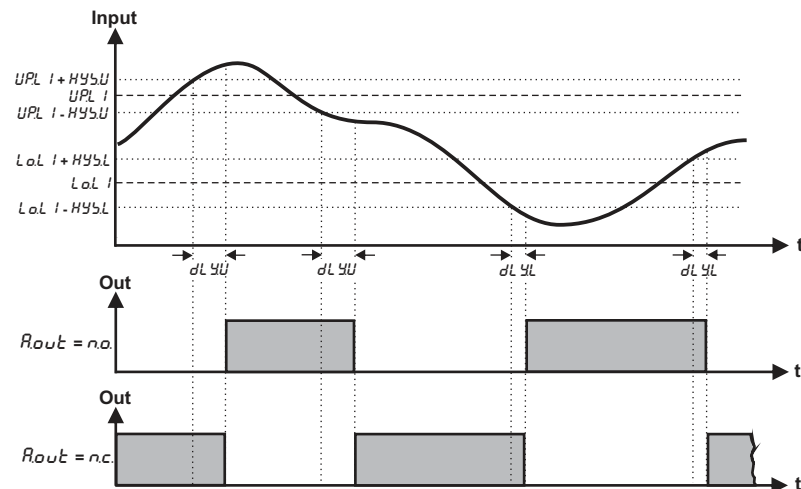

	$R_c$	$d_c$	$R_c.d_c$ (rms)
	$A \frac{1}{\sqrt{2}}$	0.000	$A \frac{1}{\sqrt{2}}$
	0.308 A	$A \frac{2}{\pi}$	$A \frac{1}{\sqrt{2}}$
	0.386 A	$A \frac{1}{\pi}$	$A \frac{1}{2}$
	A	0.000	A
	$A \frac{1}{2}$	$A \frac{1}{2}$	$A \frac{1}{\sqrt{2}}$
	$A \sqrt{\frac{d}{T} - \frac{d^2}{T^2}}$	$A \frac{d}{T}$	$A \sqrt{\frac{d}{T}}$
	$A \frac{1}{\sqrt{3}}$	0.000	$A \frac{1}{\sqrt{3}}$

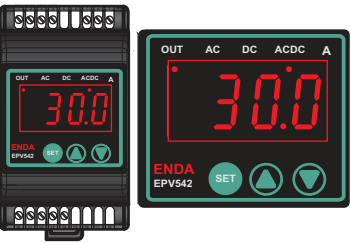

## EPV542 PROGRAMMING DIAGRAM

- Increment Key & Keylock** Used for increasing the setpoint value and changing parameters. When held down for a few seconds, configured numeric value increases faster. In "Running Mode", pressed for 3 seconds continuously, activates or deactivates keylock.
- Decrement Key** Used for decreasing the setpoint value and changing parameters. When held down for a few seconds, configured numeric value decreases faster.
- Programming Key** Used for displaying and configuring the selected parameter value.

## SETTING UP THE PARAMETERS

- 
- If key is pressed, the current value of the parameter appears by flashing on the display.
  - By using "UP" or "DOWN" navigation keys, selected parameter can be adjusted to the desired value.
  - After the setting up the parameters, if set key is pressed again, adjusted parameter name appears on display.

If these keys are pressed and held for 3 seconds, "Programming Mode" is entered or it returns to "Running Mode". If and keys are pressed while parameter names are displayed, than it returns to measured value.

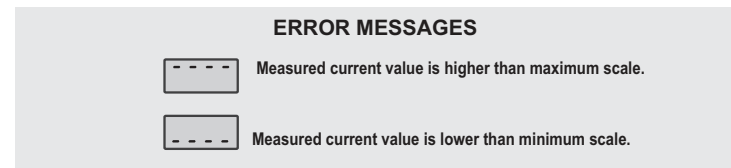
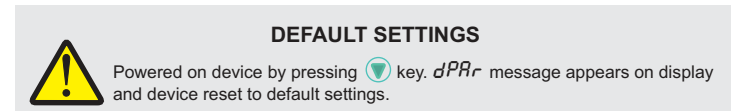
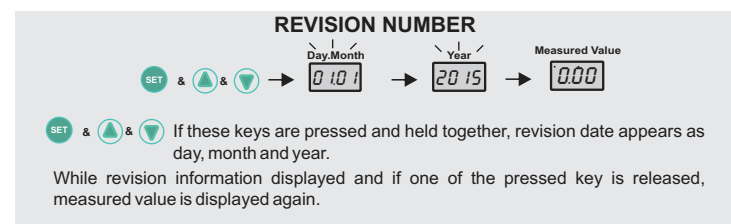
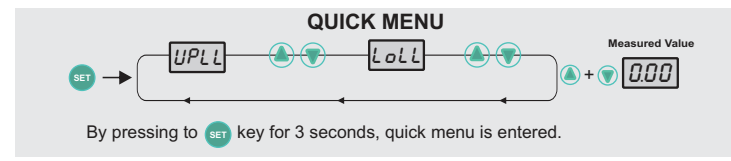
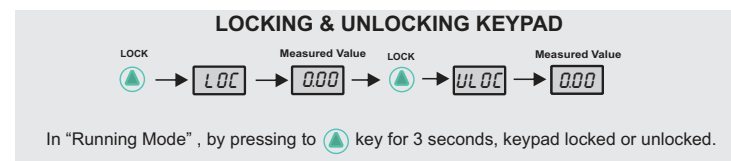
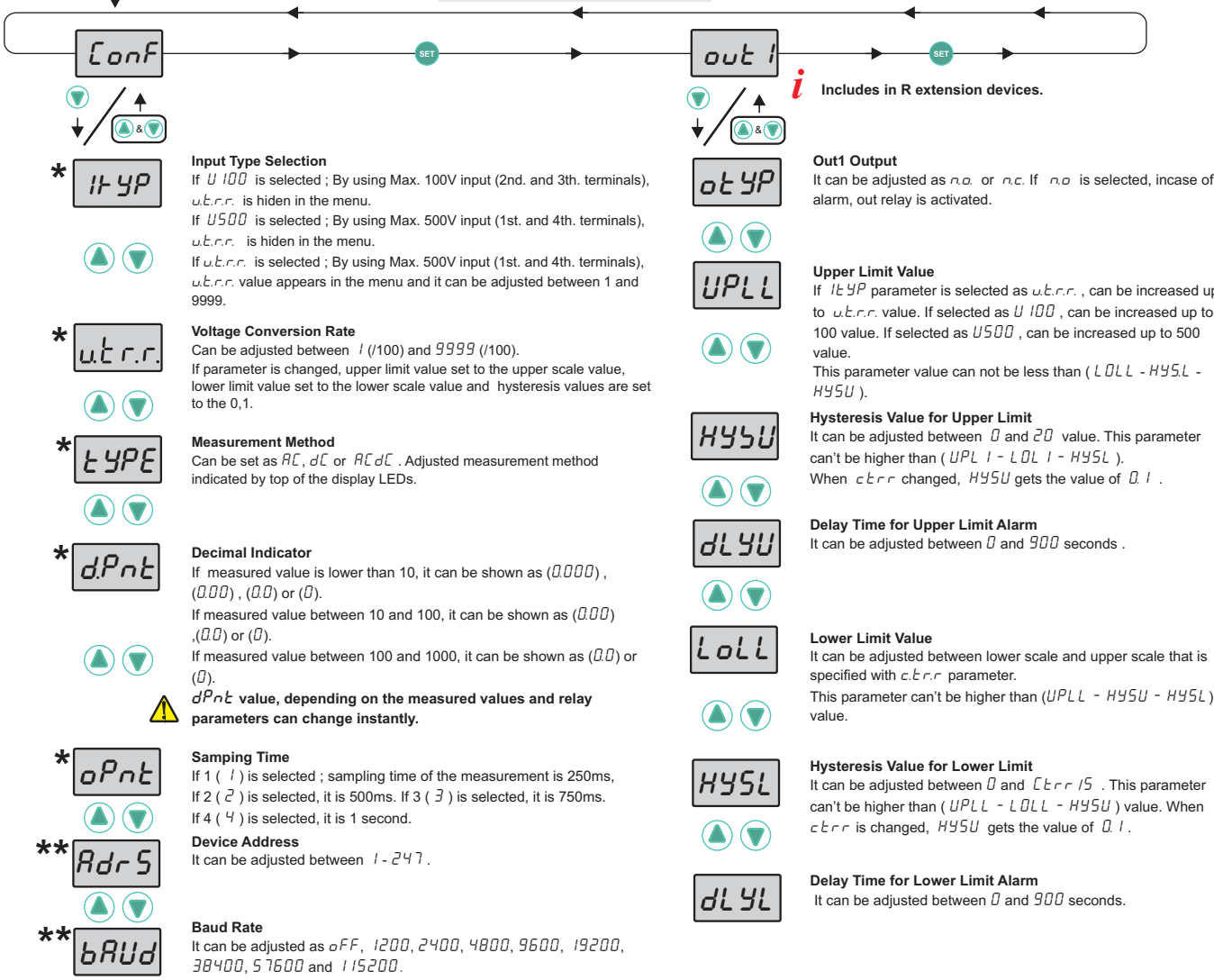

(\*) There are only *ITYP*, *u.t.r.r.*, *tYPE*, *dPnt*, *oPnt* parameters in the devices those have no relay.  
(\*\*) The *AdrS* and *bAud* parameters are only in the devices those have modbus.

# ENDA EPV542 DIGITAL VOLTMETER MODBUS PROTOCOL ADDRESS MAP

## HOLDING REGISTERS FOR R EXTENSION DEVICES

Holding Register Addresses		Data Type	Data Content	Parameter Name	Read/Write Permission	Status Value
Decimal	Hex					
0000d	0x0000	word	Alarm output status	<i>0tYP</i>	Readable/Writable	<i>no</i>
0001d	0x0001	word	Input type selection	<i>ItYP</i>	Readable/Writable	<i>u.t.r.r</i>
0002d	0x0002	word	Voltage Conversion Rate	<i>u.t.r.r</i>	Readable/Writable	<i>100</i>
0003d	0x0003	word	LSW = Low Significant Word Upper limit of the setpoint	<i>UPLL</i>	Readable/Writable	<i>1000</i>
0004d	0x0004	word	MSW = Most Significant Word (Hex. format must be sent 32bit MSW and LSW)			
0005d	0x0005	word	LSW = Low Significant Word Lower limit of the setpoint	<i>LOLL</i>	Readable/Writable	<i>0</i>
0006d	0x0006	word	MSW = Most Significant Word (Hex. format must be sent 32bit MSW and LSW)			
0007d	0x0007	word	Upper limit of the hysteresis value	<i>HYSU</i>	Readable/Writable	<i>0.1</i>
0008d	0x0008	word	Delay time for the upper limit alarm	<i>dLYU</i>	Readable/Writable	<i>0</i>
0009d	0x0009	word	The lower limit of the hysteresis value	<i>HYSL</i>	Readable/Writable	<i>0.1</i>
0010d	0x000A	word	Delay time for the lower limit alarm	<i>dLYL</i>	Readable/Writable	<i>0</i>
0011d	0x000B	word	Measurement method ( <i>0=RC, 1=dC, 2=RCdC</i> )	<i>tYPE</i>	Readable/Writable	<i>RCdC</i>
0012d	0x000C	word	Decimal point. (0=X, 1=X.X, 2=X.XX, 3=X.XXX)	<i>dPnt</i>	Readable/Writable	<i>0.0</i>
0013d	0x000D	word	Sampling time of the measurement value. If 1 is selected, it is 250ms. If 2 is selected, it is 500ms. If 3 is selected, it is 750ms. If 4 is selected, it is 1 second.	<i>oPEt</i>	Readable/Writable	<i>4</i>
0014d	0x000E	word	Device address for RS485 network connection. Adjustable between 1-247.	<i>AdRS</i>	Readable/Writable	<i>1</i>
0015d	0x000F	word	Baudrate (0=Off;1=1200;2=2400; 3=4800; 4=9600; 5=19200 6= 38400; 7= 57600; 8= 115200)	<i>bAUD</i>	Readable/Writable	<i>oFF</i>

### \*Holding Register Parameter Table (No Relay Models)

0000d	0x0000	word	Input type selection	<i>ItYP</i>	Readable/Writable	<i>u.t.r.r</i>
0001d	0x0001	word	Voltage Conversion Rate	<i>u.t.r.r</i>	Readable/Writable	<i>100</i>
0003d	0x0003	word	Measurement method ( <i>0=RC, 1=dC, 2=RCdC</i> )	<i>tYPE</i>	Readable/Writable	<i>RCdC</i>
0004d	0x0004	word	Decimal point. (0=X.XX,1=X.X,2=X)	<i>dPnt</i>	Readable/Writable	<i>0.0</i>
0005d	0x0005	word	Sampling time of the measurement value	<i>oPEt</i>	Readable/Writable	<i>4</i>
0006d	0x0006	word	Device address for RS485 network connection. Adjustable between 1-247.	<i>AdRS</i>	Readable/Writable	<i>1</i>
0007d	0x0007	word	Baudrate (0=Off;1=1200;2=2400; 3=4800; 4=9600; 5=19200 6= 38400; 7= 57600; 8= 115200)	<i>bAUD</i>	Readable/Writable	<i>oFF</i>

## INPUT REGISTERS FOR EPV542-x-xxx-RSI DEVICES

Input Register Addresses		Data Type	Data Content	Parameter Name	Read/Write Permission
Decimal	Hex				
0000d	0x0000	word	Measured voltage value	--	Only Readable

## DISCRETE INPUTS FOR R EXTENSION DEVICES

Discrete Input Addresses		Data Type	Data Content	Parameter Name	Read/Write Permission
Decimal	Hex				
0000d	0x0000	Bit	Relay output state (0= <i>oFF</i> ; 1= <i>oN</i> )	--	Only Readable

## COILS FOR R EXTENSION DEVICES

Coil Addresses		Data Type	Data Content	Parameter Name	Read/Write Permission	Status Value
Decimal	Hex					
0000d	0x0000	Bit	Alarm output state (0= <i>no</i> ; 1= <i>nc</i> )	<i>0tYP</i>	Readable/Writable	<i>no</i>

\* Coil and Discrete input parameters are not available in the devices that have no relay

**Note 1 :** *0tYP* menu parameters can be used as "Holding Register" or "Coil."

**Note 2 :** Received "ModBus input register value" is multiplying by 1000 (based on *dPnt*) and mV value reached.

For example ;

if modbus value is 2842, (for *dPnt* = 2 (*0.00*))  $2842 \times 1000 = 2842000$  mV, ie 28.42V

if modbus value is 2842, (for *dPnt* = 3 (*0.000*))  $2842 \times 1000 = 2842000$  mV, ie 2.842V

**Note 3 :** *UPLL* and *LOLL* value should be written and read in 2 bytes. Calculations in the input register is also valid for that value.

For example ; Read value (for *UPLL*) is 150200 and if *dPnt* = 1, this value is actually (150.2).

It is, 150200d (24A88h) ; LSW = 4A88h, MSW = 0002h.