

ENDA ETS Serisi Ray ve Panel Montajlı Soğutucular

ENDA ürünlerini tercih ettiğiniz için teşekkür ederiz.

ETS serisi ray ve panel montajlı soğutucular, EPxA1 ve EPxA3 serisi Panel Montajlı Solid State Röleler ile kullanılmak üzere tasarlanmıştır.

SİPARİŞ KODU

ETS-62-100F		Fan	
Ürün Temel Kodu		Fan	
Soğutucu ETS		F	
Genişlik		Derinlik	
46mm	46	62mm	62
62mm	62	80mm	80
99mm	99	100mm	100

ENDA ETS-46-100 RAY MONTAJLI SOĞUTUCU

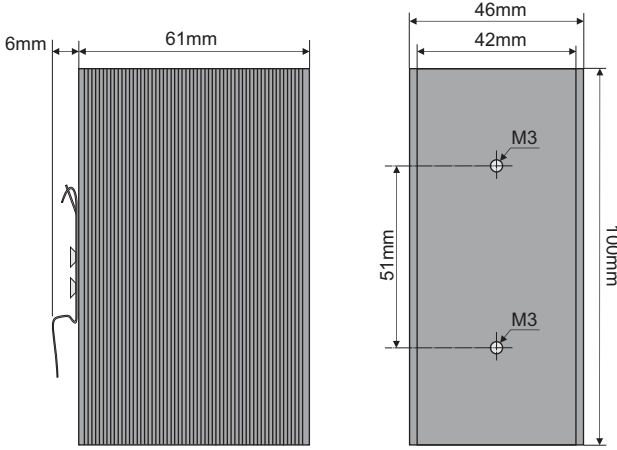

ENDA ETS-46-80

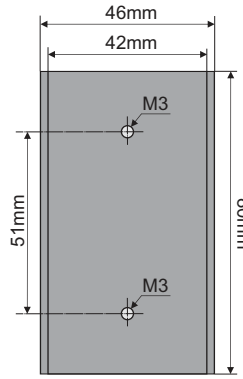

ENDA ETS-46-62

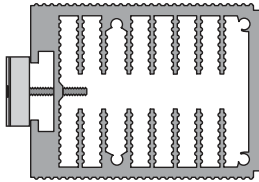
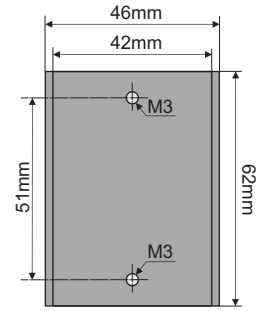

- Soğutucuyu raydan çıkarmak için; 1 yönünde yukarı kaldırırsınız.
- Soğutucuyu raya monte etmek için; 2 yönünde aşağı itiniz.

ENDA ETS-46-100F RAY MONTAJLI SOĞUTUCU

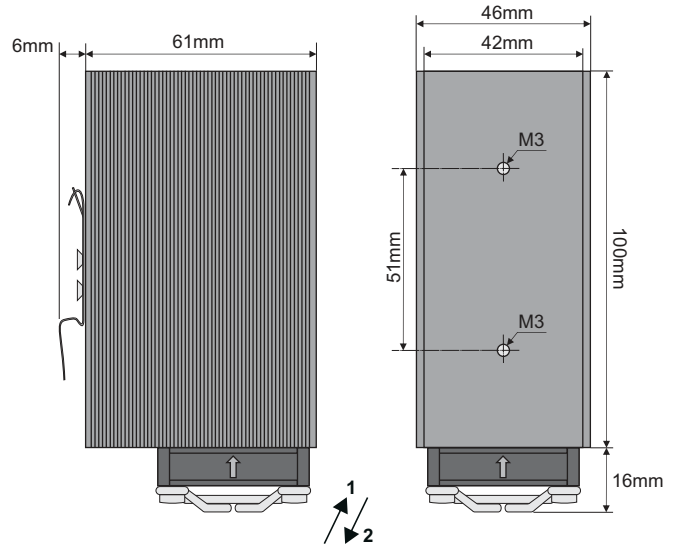

- Soğutucuyu raydan çıkarmak için; 1 yönünde yukarı kaldırırsınız.
- Soğutucuyu raya monte etmek için; 2 yönünde aşağı itiniz.

Fan Beslemesi : 24VDC, 100mA.
Yukarıdaki gibi fan aşağıda kalacak şekilde monte edilmelidir.

Soğutucu	SSR Akımı (Amper)	Boyutlar GxYxD (mm)	Termal Direnç (°C/W)
ETS-46-62	12-25	46x61x62	2,0
ETS-46-80	20-25	46x61x80	1,7
ETS-46-100	25-40	46x61x100	1,5
ETS-62-100	40-50	62x77x100	1,0
ETS-99-100	3x25	99x87x100	0,75
ETS-46-100F	50-70	46x61x110	0,7
ETS-62-100F	70-120	62x77x120	0,4
ETS-99-100F	3x40-3x50	99x87x125	0,34

ENDA ETS-62-100F RAY VE PANEL MONTAJLI SOĞUTUCU

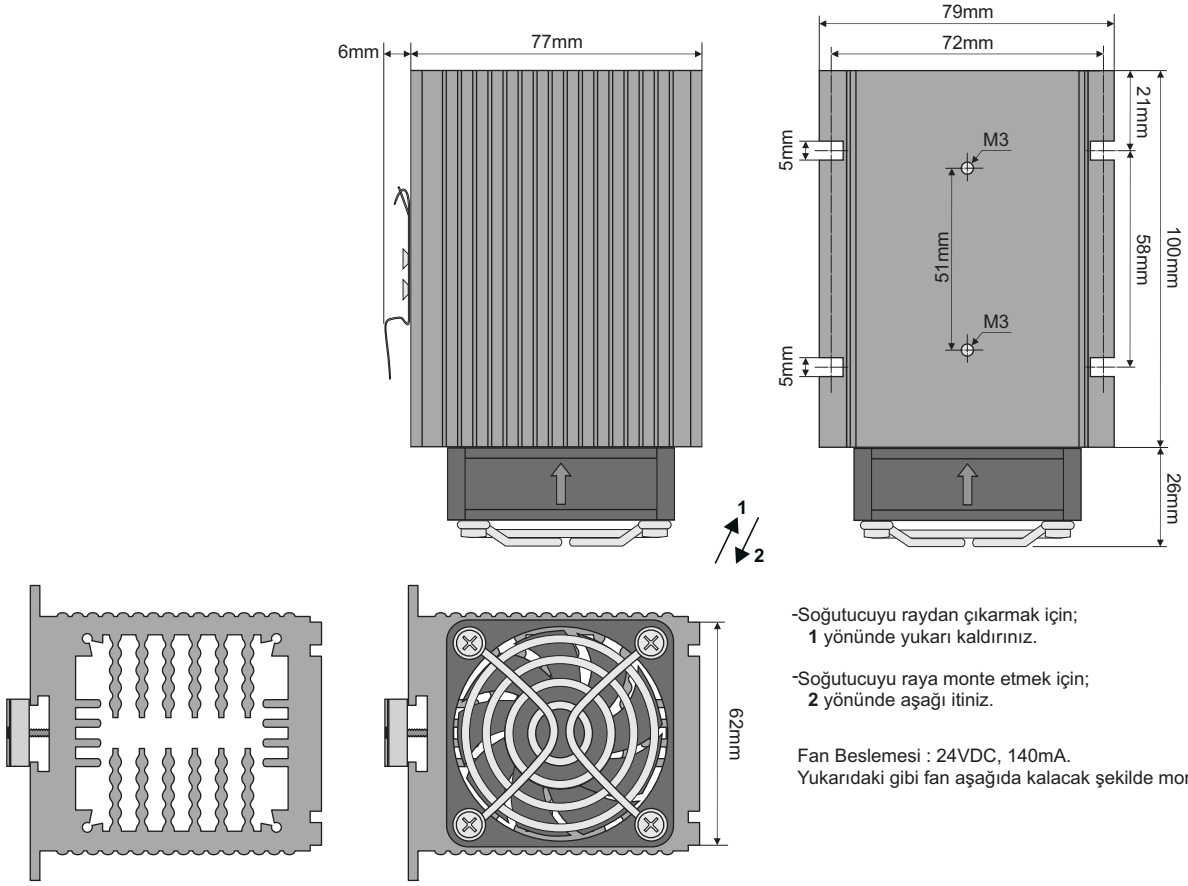

ENDA ETS-99-100F RAY VE PANEL MONTAJLI SOĞUTUCU

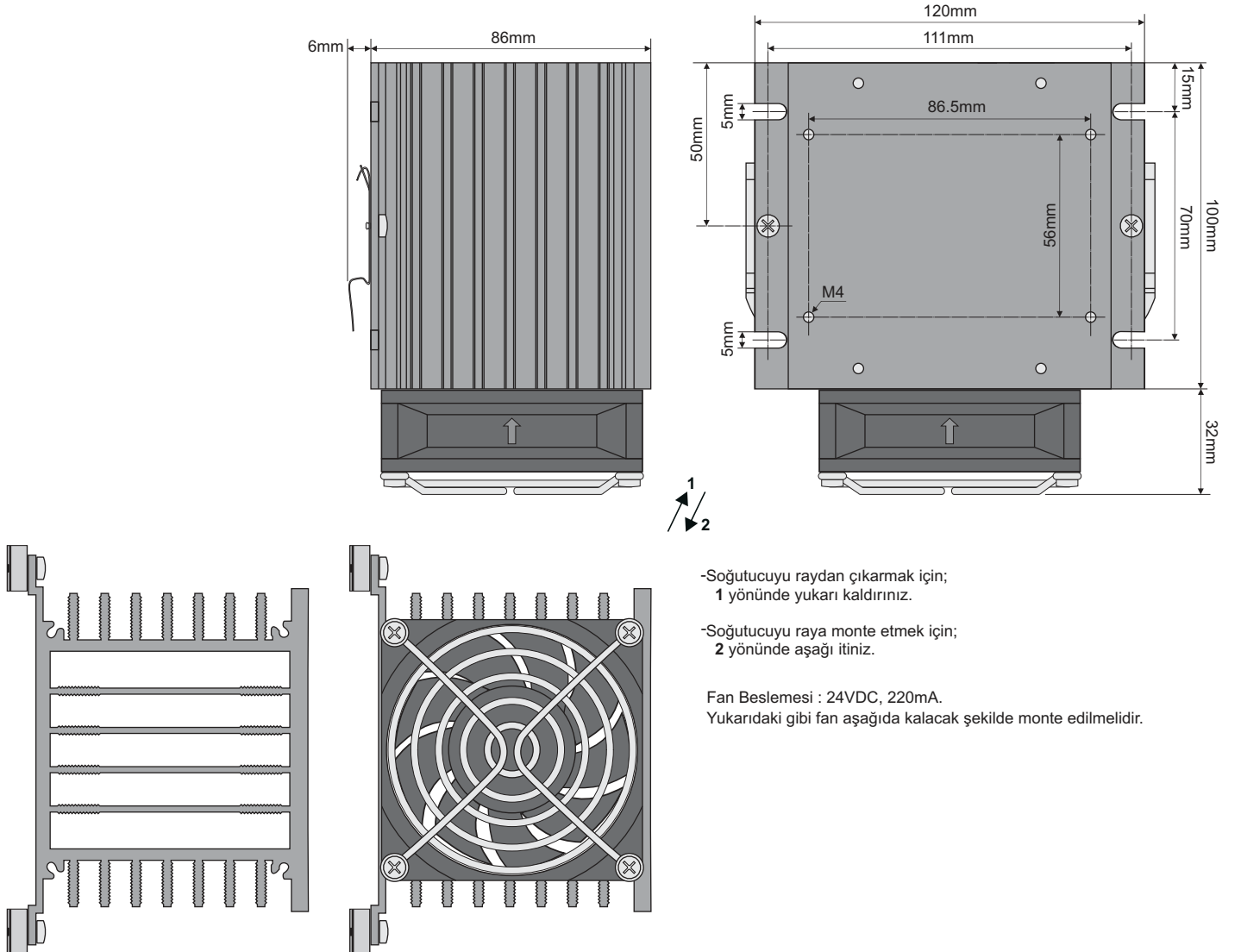

ENDA Panel Montajlı SSR'ler için ETS Serisi Soğutucular ile Sıcaklık / Akım Eğrileri

EPxA1-212Z

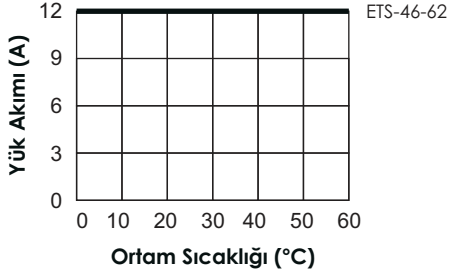

EPxA1-225Z

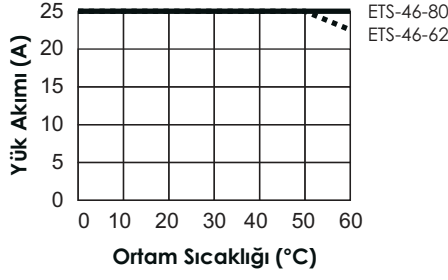

EPxA1-240Z

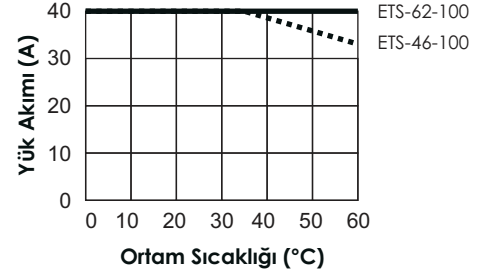

EPxA1-425Z

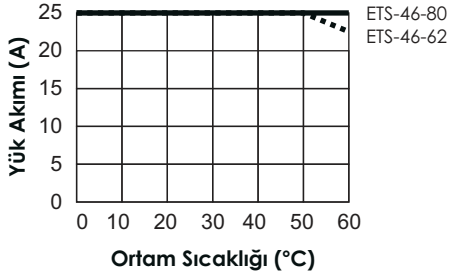

EPxA1-440Z

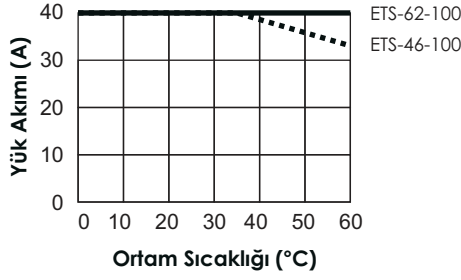

EPxA1-450Z

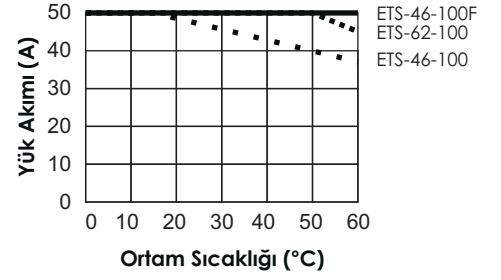

EPxA1-470Z

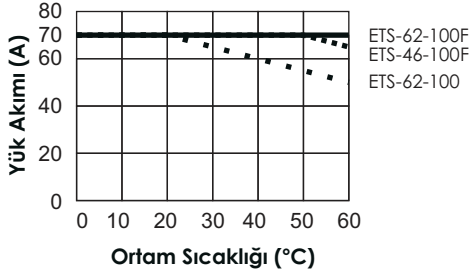

EPxA1-4100Z

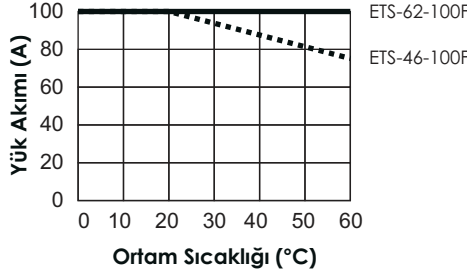

EPxA1-4120Z

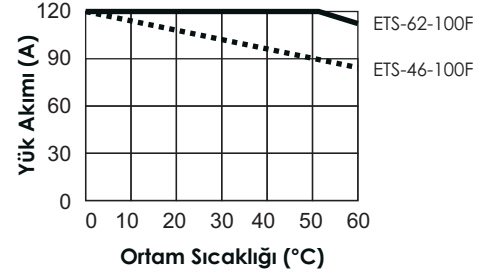

EPxA3-425Z

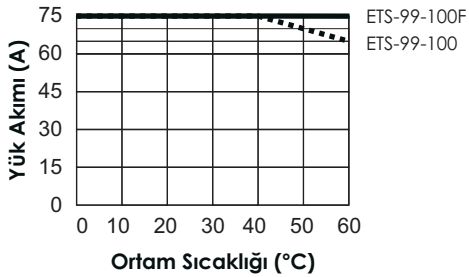

EPxA3-440Z

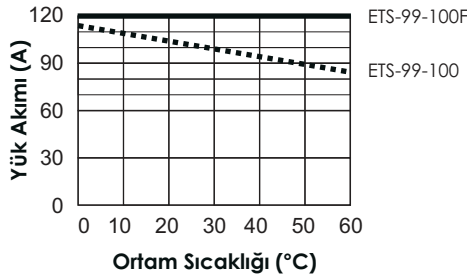

EPxA3-450Z

